



Performance Vehicles / Parts / Racing

Retail Price \$9.95
CP Number 37
P/N 19540548
Supersedes all previous catalogs

2025 CATALOG

Engineered for Performance.



Built to Last.

Chevrolet Performance parts are designed, engineered, tested and validated to meet Chevrolet's rigorous standards for quality, endurance, performance and fit. *See Page 6 for Details*

CRATE ENGINES



TRANSMISSIONS



COMPONENTS



AND MORE!



ZZ632/1000 Big-Block
Page 186

6L80-E Transmission
Page 26

RSX Aluminum Head Assembly
Page 195

NEW LS3 Power Upgrades
Page 50



Performance

Vehicles / Parts / Racing

On The Cover:

Classic Chevy C10 driven by all-new L8P 6.6L crate engine

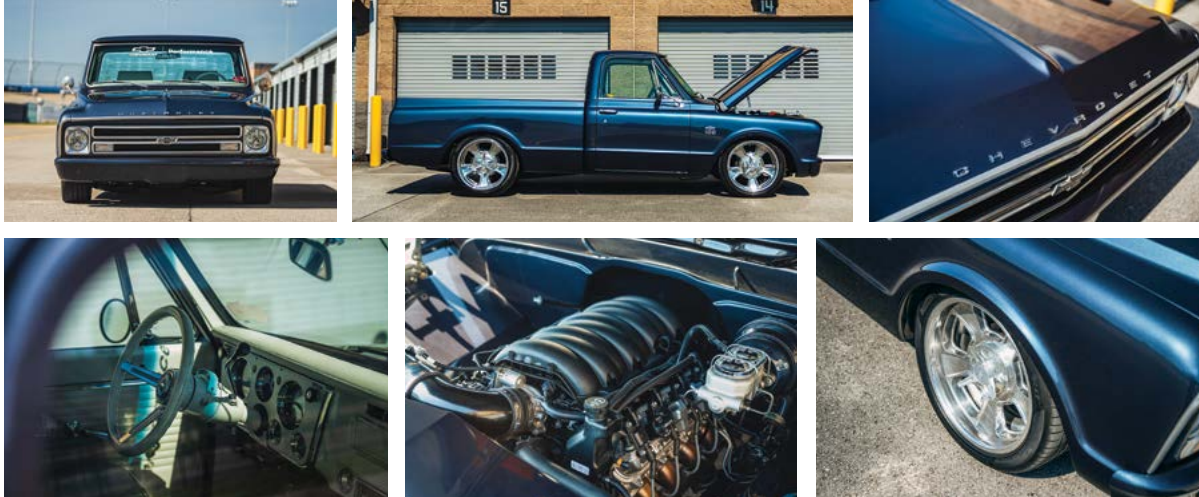

To showcase the all-new L8P 6.6L crate engine, Chevrolet Performance engineers have swapped it into our 1967 C10 pickup, giving the classic truck the latest in Gen V LT performance.

The L8P is based on the production L8T engine offered in today's Chevrolet Silverado 2500HD and 3500HD models, combining its displacement and heavy-duty components with a unique non-AFM LT2-based camshaft, which is based off the Corvette Stingray's high-revving LT2 V-8. The result is 523 naturally aspirated horsepower, 543 lb.-ft. of torque, and every cubic inch of those 6.6L being optimized for performance. Bring the power of a truck and a great sounding engine to your next project.

In the C10, the L8P is paired with a Chevrolet Performance SuperMatic™ 6L80-E six-speed automatic transmission.

The truck itself has been a platform and test bed for previous Chevrolet Performance crate engines and components. It started life as a standard long-bed model, with the frame and bed shortened to match the dimensions of the short-bed model that remains popular with vintage truck enthusiasts. Additionally, the ride height was lowered with custom springs and drop spindles, while the exterior was customized with smoothed and tucked-in bumpers. It also rolls on 20-inch wheels.

Our L8P-swapped C10 is part of the Chevrolet Performance display traveling to events across the United States. Be sure to keep an eye out for it!

Every effort is made to make this catalog comprehensive and factual. We reserve the right, however, to make changes at any time, without notice, to materials, equipment, specifications and availability. Specifications, dimensions, measurements, ratings and other numbers are based on design and engineering information, prototypes and laboratory tests. Some information may have been updated since the time of printing. Please check with your dealer for complete details.

The parts listed in this catalog are intended primarily for use in racing, track applications or "off-road" vehicles—they are not intended for use on public roads. U.S. federal law and Canadian law prohibit an automobile manufacturer or dealer from removing, modifying or rendering inoperative any part installed in compliance with an applicable Federal Motor Vehicle Safety Standard on a motor vehicle used on public roads.

Many parts intended for use on private property, including racing on a track, are not designed or tested for crashworthiness or to meet safety standards applicable to public-road use, and may adversely affect the original intended performance or handling characteristics of the vehicle. These parts are designed and intended to be used with experts supervising their installation and use to help assure the proper and safe operation of the vehicle.

Vehicles equipped with Chevrolet Performance Parts also may not meet U.S. federal, state, or local emission laws, regulations, or ordinances, and may not be operated on public roads, streets, or highways or for non-competition purposes. Further, the federal government and many states and provinces have enacted laws with various penalties for tampering with or otherwise modifying any required emission or noise control system. Chevrolet Performance customers are responsible for ensuring their use of Chevrolet Performance Parts complies with applicable federal, state and local laws, regulations and ordinances.

For additional information on compliance with emissions laws, please see Page 2 or www.chevroletperformance.com/emissions.



WARNING: Auto parts in this book can expose you to chemicals including phthalates and lead. Installing or using these parts can expose you to other parts containing these chemicals and to engine exhaust, which are known to the State of California to cause cancer and birth defects or other reproductive harm. For more information go to www.P65Warnings.ca.gov.

Table of Contents

Emissions Compliance	2	Head Gaskets & Bolts.....	96	Camshafts & Components.....	155
CRATE ENGINES & COMPONENTS INTRO		Rocker Arms	97	Connecting Rods & Components	156
Introduction	3	Pushrods	97	Pistons & Rings.....	156
Crate Engine Quick Reference Charts.....	4	Valves & Valve Springs	97	Crankshafts	156
Crate Engine Levels	5	Valve Covers.....	98	Balancers & Pulleys.....	157
Testing and Validation Procedures.....	6	Valve Cover Hardware	98	Flywheels & Flexplates.....	157
Engine & Transmission Dimensions	7	Valve Lifters	99	Timing Chains & Sprockets.....	158
PERFORMANCE UPGRADES & ACCESSORIES		Power Upgrade Kits.....	99	Water Pumps & Components	158
Introduction	8	Camshafts & Components.....	99	Accessory Drive Systems	159
Corvette	9	Connecting Rods & Components	100	Oil Pans & Accessories.....	159
Camaro.....	11	Pistons & Rings.....	101	Distributors & Components.....	160
Silverado	12	Crankshafts & Components	102	Intake Manifolds & Components.....	161
Tahoe/Suburban	15	Flywheels & Flexplates.....	103	Starters	164
Colorado.....	16	Timing Chains & Sprockets.....	103	Spark Plug Wires	164
TRANSMISSIONS & COMPONENTS		Accessory Drive Systems	104	Carburetors & Air Cleaners	165
Introduction	20	Balancers	108	Fuel Pumps	165
Torque Converters	22	Water Pumps & Components	108	BIG-BLOCK CRATE ENGINES	
Automatic Transmissions	24	Oil Pans & Accessories.....	109	Introduction	166
Manual Transmissions.....	29	Intake Manifolds	109	ZZ427/480	168
CONNECT & CRUISE SYSTEMS		Dry Sump Components.....	111	454HO	170
Introduction	32	Starters	111	ZZ454/440	172
Automatic/Fuel Injected Systems.....	35	Carburetors & Air Cleaners	112	HT502	174
Automatic/Carbureted Systems	36	Electrical and Fuel Components	113	502 HO.....	176
Manual Systems	37	Spark Plug Wires	113	ZZ502/502 Deluxe.....	178
eCRATE ELECTRIC CONVERSION KIT		Fuel Pumps	113	ZZ502/502 Base.....	179
Introduction	38	Engine Control Modules.....	114	SP502/605 Deluxe.....	180
eCrate Drive Motor	38	SMALL-BLOCK CRATE ENGINES		ZZ572/620 Deluxe	182
eCrate Battery Pack	39	Introduction	116	ZZ572/620 Base.....	183
eCrate Control Modules & Accessories	39	350 HO Turn-Key.....	118	ZZ572/720R Deluxe	184
LS-SERIES CRATE ENGINES		350 HO Deluxe	119	ZZ632/1000 Deluxe.....	186
Introduction	40	350 HO Base	119	BIG-BLOCK COMPONENTS	
LS Engine Family Tree	42	SP350/357 Turn-Key	120	Introduction.....	188
LS-Series Power Upgrades	50	SP350/357 Deluxe.....	121	Blocks & Components.....	189
LS3	52	SP350/357 Base	121	Cylinder Heads.....	193
LS3 Long Block.....	53	SP350/385 Turn-Key.....	122	Head Gaskets & Bolts.....	196
LS364/450	54	SP350/385 Base.....	123	Valves	196
LS376/480.....	56	ZZ6 Turn-Key.....	124	Valve Springs	197
LS376/480 Long Block.....	57	ZZ6 Base.....	125	Rocker Arms	197
LS376/515.....	58	ZZ6 EFI Turn-Key.....	126	Pushrods	197
LS376/525.....	60	ZZ6 EFI Deluxe.....	127	Valve Covers.....	198
LS376/525 Long Block.....	61	HT383	128	Hardware & Breathers	199
DR525	62	HT383E.....	130	Guide Plates and Lifters.....	200
LS9 Long Block.....	64	SP383 Turn-Key.....	132	Camshafts & Components.....	200
LT-SERIES CRATE ENGINES		SP383 Deluxe.....	133	Pistons & Rings.....	201
Introduction	66	SP383 Base.....	133	Connecting Rods & Components	201
LT1	68	SP383 EFI Turn-Key	134	Crankshafts	201
LT4.....	70	SP383 EFI Deluxe.....	135	Balancers	202
L8T	72	CIRCLE TRACK CRATE ENGINES		Flywheels & Flexplates.....	202
L8T Long Block.....	73	Introduction	136	Timing Chains & Sprockets.....	203
L8P	74	CT350	137	Water Pumps & Components	203
E-ROD CRATE ENGINE SYSTEMS		CT400	138	Oil Pans & Accessories.....	203
Introduction	76	CT525	139	Distributors & Components.....	204
LT1 E-ROD System.....	78	525 RLB	140	Intake Manifolds & Components.....	205
LT4 E-ROD System	79	SMALL-BLOCK COMPONENTS		Starters	207
LSX-SERIES CRATE ENGINES		Introduction.....	142	Carburetors & Throttle Bodies.....	207
Introduction	80	Blocks & Components.....	143	Air Cleaners.....	208
LSX376-B15	82	Cylinder Heads.....	146	Spark Plug Wires	208
LSX454	84	Head Gaskets & Bolts.....	149	Fuel Pumps	208
LS/LT/LSX-SERIES COMPONENTS		Valves	150	LICENSED PARTS	
Introduction	86	Valve Springs	150	Dress Parts.....	209
Blocks & Components.....	87	Rocker Arms	151	GM Restoration Parts Listing.....	214
Cylinder Heads.....	92	Valve Covers.....	152	REFERENCE	
		Adapters, Hardware & Breathers	153	Authorized Centers	217
		Pushrods	154	Warranty Information.....	222



Performance

Vehicles / Parts / Racing

CHEVROLET PERFORMANCE PARTS COMPLIANCE WITH EMISSIONS STANDARDS

Motor vehicle emissions standards are intended to help achieve and maintain air quality goals that benefit human health and the environment. U.S. federal and state and Canadian law prohibits knowingly removing, modifying, or making inoperative, or causing someone to remove or render inoperative, or otherwise tampering with, any part or element of design installed in compliance with motor vehicle emission standards on a motor vehicle or nonroad vehicle, or otherwise modifying any required emission and noise control systems. The emissions-related Chevrolet Performance Parts listed in this catalog that are identified as competition use only (by use of the "Checkered Flag" icon) should not be installed or otherwise used or operated in vehicles that are:

- (1) "motor vehicles" used on public roads, streets or highways at any time; or
- (2) off-road vehicles, unless used exclusively for competition motorsports.

U.S. federal and state and Canadian provincial agencies have the authority to impose substantial civil and criminal penalties against individuals and companies that do not comply with these laws. Chevrolet Performance customers are responsible for ensuring their use of Chevrolet Performance Parts complies with applicable federal, state/provincial and local laws, regulations and ordinances, and for ensuring that modified vehicles are operated in a manner that complies with applicable laws. In an effort to help customers comply with emissions laws, the product descriptions for many parts include emissions-related warnings and notices. This page summarizes the emissions-related information that you may see in this catalog.

PARTS INTENDED FOR COMPETITION USE ONLY

The Chevrolet Performance Catalog includes parts that are intended exclusively for use in competition vehicles that will be driven only on a racetrack or off-road course and not on public roads, streets, or highways. These are denoted by a "Checkered Flag" icon. By "competition vehicles," GM means vehicles used exclusively for competitions organized and sanctioned by a local or private body and conducted on a closed circuit or other non-public road. Customers should not install parts accompanied by this warning on vehicles that will be driven on public roads, streets, or highways, as those parts are not designed, tested, or certified for that purpose. The product descriptions for such parts are accompanied by the following warning icon:



WARNING: NOT EMISSIONS LEGAL FOR STREET USE; INTENDED FOR USE ONLY IN RACING/COMPETITION MOTORSPORT VEHICLES

Because of their effect on a vehicle's emissions performance, certain parts in the Chevrolet Performance Catalog are intended exclusively for use in competition vehicles. The "Checkered Flag" icon means a part is designed and intended for use in vehicles operated exclusively for competition: in racing or organized competition on courses separate from public streets, roads, or highways. Installation or use of this part on a vehicle operated on public streets, roads or highways is likely to violate U.S., Canadian, and state and provincial laws and regulations relating to motor vehicle emissions.

PARTS THAT HAVE RECEIVED A CALIFORNIA EXECUTIVE ORDER

Manufacturers of add-on and modified emissions-related parts (aftermarket parts) that sell their product for use in California vehicles must obtain an exemption from the California Air Resources Board (CARB). This exemption is called an Executive Order (EO) and allows the part or modification to be installed on specific emission-controlled engines, vehicles, or equipment. An EO is granted if the product has been determined not to reduce the effectiveness of required motor vehicle or off-highway motor vehicle pollution control devices or result in emissions levels that do not comply with existing state or federal standards for the same vehicle model year for which the part is approved, nor otherwise cause engines, vehicles, or equipment to be noncompliant with the vehicle emissions certification and anti-tampering laws.

Every aftermarket part that has been exempted by CARB is assigned an EO number and is subject to installation and use restrictions. The EO number will appear on a special exemption label affixed to the part or its packaging. Consumers are advised to familiarize themselves with the EO and its limitations and restrictions to ensure that such parts are installed and used properly. The product descriptions for some parts listed in the Chevrolet Performance Catalog are accompanied by the "50 State" icon:



The "50 State" icon means that this part has undergone an evaluation by the California Air Resources Board (CARB) and that CARB has determined that the part or modification has been shown to not increase emissions in violation of applicable standards when installed and used properly in the vehicle application(s) identified in the product description and EO. CARB policy authorizes consumers to install and use these parts in specified vehicles driven on public streets and highways. Emissions-related parts that have an EO list the EO number that can be used to locate the installation and use restrictions of that part on CARB's website: <https://www.arb.ca.gov/msprog/aftermkt/devices/amquery.php>.

FOR MORE INFORMATION

General Motors is committed to performance parts development that allows enthusiasts to modify their vehicles and remain compliant with emissions requirements. The information provided here is intended to provide general guidance of interest to most consumers, and may not apply to all vehicles or all situations.

For more information, visit the General Motors Performance Parts Website at www.chevroletperformance.com/emissions



Crate Engines and Engine Components

MORE CHOICES TO POWER YOUR PROJECT!

Our expansive portfolio of production-based and specialty high-performance crate engines and engine components has been rigorously tested and validated to meet Chevrolet's tough standards for quality, endurance, performance and fit. From our Classic Big-Block and Small-Block crate engines, to the technology packed LS, LSX and LT lines—and even a lineup of factory-sealed, purpose-built racing engines—Chevrolet Performance has something for every enthusiast.

To help make things even easier and get your project finished quicker, check out our innovative Connect & Cruise Crate Powertrain Systems that match our crate engines with complementing transmissions and all the necessary controllers and installation kits, for the ultimate in selection convenience. We even offer them with our CARB-compliant E-ROD crate engines!

For those who want to tackle more of their project themselves, Chevrolet Performance also offers a complete line of individual engine parts and accessories, along with transmissions, controllers and more.

No matter what you're building, Chevrolet Performance offers more choices than ever!



*6L80-E Six-Speed
Automatic Transmission*



*LS3 Connect & Cruise with
Super Magnum Six-Speed
Manual Transmission*



L8P 6.6L Crate Engine













LSX Bowtie Block







*RS-X Spread-Port
Big-Block Cylinder Heads*

Crate Engine & Transmission Quick Reference Charts



Chevy LS-Series Small-Block V-8

Part Number	Description	Engine Size	Weight ¹	hp	Torque	Page	Warranty
19540155	LS3 6.2L – Gen IV V-8	6.2L	415	430	425	52	
19435106	LS3 Long Block	6.2L	384	430	425	53	
19434650	LS364/450	6.0L	N/A	452	441	54	
19540156	LS376/480 – EFI LS3 Gen IV V-8	6.2L	415	495	473	56	
19435108	LS376/480 Long Block	6.2L	384	495	473	57	
19435102	LS376/515 – Carbureted LS3 Gen IV V-8	6.2L	415	533	477	58	
19540157	LS376/525 – EFI LS3 Gen IV V-8	6.2L	415	525	486	60	
19435110	LS376/525 Long Block	6.2L	384	525	486	61	
19434599	DR525 with Gen 4 F-Car Oil Pan	6.2L	415	525	498	62	
19434600	DR525 with Muscle Car Oil Pan	6.2L	415	525	494	62	
12624262	LS9 Long Block	6.2L	377	638	604	64	





















Chevy LT-Series Small-Block V-8

Part Number	Description	Engine Size	Weight ¹	hp	Torque	Page	Warranty
19431953	LT1 6.2L with wet sump	6.2L	425	455	455	68	
19431955	LT4 6.2L SC with wet sump	6.2L	450	650	650	70	
19435733	L8T 6.6L	6.6L	590	401	464	72	
19433750	L8T Long Block	6.6L	549	401	464	73	
19435523	L8P 6.6L	6.6L	590	523	543	74	





Chevy LSX-Series Small-Block V-8

Part Number	Description	Engine Size	Weight	hp	Torque	Page	Warranty
19417356	LSX376-B15	6.2L	N/A	473	444	82	
19417357	LSX454	7.4L	N/A	627	586	84	

Chevy Small-Block V-8

Part Number	Description	Engine Size	Weight	hp	Torque	Page	Warranty
19433031	350 HO Turn-Key	350 cu in	575	333	381	118	
19433038	350 HO Deluxe	350 cu in	481	333	381	119	
19433030	350 HO Base	350 cu in	298	333	381	119	
19433034	SP350/357 Turn-Key	350 cu in	575	357	407	120	
19433033	SP350/357 Deluxe	350 cu in	450	357	407	121	
19433032	SP350/357 Base	350 cu in	300	357	407	121	
19435619	SP350/ZZ6 Partial Engine	350 cu in	282	N/A	N/A	121	
19433040	SP350/385 Turn-Key	350 cu in	410	385	405	122	
19433039	SP350/385 Base	350 cu in	510	385	405	123	
19433042	ZZ6 Turn-Key	350 cu in	410	405	406	124	
19433041	ZZ6 Base	350 cu in	405	405	406	125	
19433044	ZZ6 EFI Turn-Key	350 cu in	430	420	408	126	
19433043	ZZ6 EFI Deluxe	350 cu in	410	420	408	127	
19433036	HT383	383 cu in	405	323	444	128	
19435620	383 Partial Engine	383 cu in	335	N/A	N/A	129	
19435449	HT383E	383 cu in	450	323	444	130	
19435452	SP383 Turn-Key	383 cu in	N/A	435	445	132	
19433035	SP383 Deluxe	383 cu in	410	435	445	133	
19435450	SP383 Base	383 cu in	N/A	435	445	133	
19433046	SP383 EFI Turn-Key	383 cu in	430	450	436	134	
19433045	SP383 EFI Deluxe	383 cu in	410	450	436	135	

Chevy Circle Track Racing Engines

Part Number	Description	Engine Size	Weight	hp	Torque	Page	Warranty
19435602	CT350	350 cu in	517	350	396	137	
19435604	CT400	350 cu in	470	404	406	138	
19434598	CT525	376 cu in	415	533	477	139	
19435005	525 RLB	376 cu in	400	533	477	140	

Warranty Information



Chevrolet Performance Crate Engines include a 24-month or 50,000-mile/80,000-kilometer limited warranty, whichever comes first. See your GM dealer for details.

















Chevrolet Performance Parts include a 12-month/unlimited mile limited warranty.



Chevrolet Performance Racing Crate Engines are purpose-built for racing only, and have no warranty.

Chevy Big-Block V-8 

Part Number	Description	Engine Size	Weight	hp	Torque	Page	Warranty
19331572	ZZ427/480	427 cu in	520	480	490	168	
19433409	454 HO – with iron heads and roller cam	454 cu in	590	438	500	170	
19433375	454 Partial Engine	454 cu in	361	N/A	N/A	171	
19433410	ZZ454/440 Deluxe	454 cu in	522	469	519	172	
19433156	HT502 – truck replacement engine	502 cu in	557	406	541	174	
19433158	502 Partial Engine	502 cu in	402	N/A	N/A	175	
19433157	502 HO – with iron heads and roller cam	502 cu in	602	461	558	176	
19433162	ZZ502/502 Deluxe – with aluminum heads	502 cu in	611	508	580	178	
19433160	ZZ502/502 Base	502 cu in	504	508	580	179	
19421200	SP502/605 Deluxe	502 cu in	400	605	580	180	
19331583	ZZ572/620 Deluxe	572 cu in	688	621	645	182	
19331581	ZZ572/620 Base	572 cu in	622	621	645	183	
19331585	ZZ572/720R Deluxe	572 cu in	677	727	680	184	
19432060	ZZ632/1000 Deluxe	632 cu in	625	1004	876	186	

Available Transmissions

Part Number	Description	Page
19368611	SuperMatic™ 4L65-E Four-Speed Automatic	24
19368613	SuperMatic™ 4L70-E Four-Speed Automatic– 2WD	24
19368612	SuperMatic™ 4L70-E Four-Speed Automatic – 4WD	24
19368614	SuperMatic™ 4L70-E Four-Speed Automatic – LT1 2WD	24
19368615	SuperMatic™ 4L75-E Four-Speed Automatic	24
19300175	SuperMatic™ 4L85-E Four-Speed Automatic	25
19366637	SuperMatic™ 6L80-E Six-Speed Automatic Transmission – LS/LSX 2WD with 2400-2800k stall converter (included)	26
19417102	SuperMatic™ 6L80-E Six-Speed Automatic Transmission – LS/LSX 2WD with 3000-3400k stall converter (included)	26
19432680	SuperMatic™ 6L80-E Six-Speed Automatic Transmission – LS/LSX 4WD with 2400-stall converter (included)	26
19432790	SuperMatic™ 6L80-E Six-Speed Automatic Transmission – LS/LSX 4WD with 3000-stall converter (included)	26
19432682	SuperMatic™ 6L80-E Six-Speed Automatic Transmission – LT1/LT4/L8T/L8P 2WD with 2400-stall converter (included)	26
19432684	SuperMatic™ 6L80-E Six-Speed Automatic Transmission – LT1/LT4/L8T/L8P 2WD with 3000-stall converter (included)	26
19435284	SuperMatic™ 6L80-E six-speed Automatic Transmission – LT1/LT4/L8P 4WD with 2400k stall converter (included)	26
19435286	SuperMatic™ 6L80-E six-speed Automatic Transmission – LT1/LT4/L8P 4WD with 3000k stall converter (included)	26
19419798	SuperMatic™ 8L90-E Eight-Speed Automatic – LT1	27
19419799	SuperMatic™ 8L90-E Eight-Speed Automatic – LT4	27
19436466	SuperMatic™ 10L90-E Ten-Speed Automatic – LT1	28
19436467	SuperMatic™ 10L90-E Ten-Speed Automatic – LT4	28
19435613	SuperMatic™ 10L90-E Ten-Speed Automatic – L8T	28
19352208	Super Magnum Six-Speed Manual Transmission	29

Different Levels of Engine Assemblies

Recognizing that each customer has unique needs, Chevrolet Performance offers four distinct levels of Crate Engines, covering the gamut from starter partial engines to complete Turn-Key engines that are ready to be dropped into your favorite vehicle. This variety gives builders the opportunity to customize an engine as much or as little as they need to meet their expectations.

**Partial**

This is for the builder who wants to start from the block up. These engines typically include the block and reciprocating assembly, allowing the builder to choose the heads, cam and intake combination they want.

**Base**

The Base engine assembly typically includes block, crank, pistons, cam, heads and valve covers, but allows builders to pick the carburetor/injection system and intake manifold they desire.

**Deluxe**

The Deluxe crate engines are essentially ready to fire up, as they ship with the distributor installed, harmonic balancer bolted on and the carburetor in the crate. All you need to do is put the parts together and go!

**Turn-Key**

Our Turn-Key engines are the complete package! They typically ship with the, intake, balancer and distributor installed and also include the carburetor, front end kit, air cleaner, starter, water pump and spark plug wires in the crate.

Trust is built into Chevrolet Performance crate engines and components.

Trust doesn't come easily. It's earned through capability and experience — and that's exactly what you get with Chevrolet Performance parts.

Our experience with performance engines started 70 years ago, with the very first Small-Block, and we've continued to refine our formula, balancing horsepower with durability. That goes for our Small-Block and Big-Block engines as well as the LS-Series and the latest LT engines.

Each engine family offers unique performance characteristics, but they all share the same approach to engineering and testing that goes into Chevrolet's production powertrain systems. Starting with CAD designs that are translated into production engines, every stage of the process combines innovation, craftsmanship and an unwavering attention to detail fueled by our passion for performance.

That means every Chevrolet Performance crate engine endures the same rigorous OE validation procedures before its approved for production, positioning Chevrolet Performance Parts ahead of the competition.

HORSEPOWER AND TORQUE TESTING PROCEDURES

To make sure our engines deliver on their promise of performance, they are tested in a controlled environment on a dynamometer following the Society of Engineers (SAE) standard test procedures J1349 for net power testing or J1995 for gross power testing.

Atmospheric correction factors for J1349 use a temperature of 77°F and a barometric pressure of 29.31 inHg. The J1995 correction factors are derived from SAE test J607 correcting to standard temperature and pressure conditions of 60°F and 29.92 inHg. Formally declared values meet the requirements within SAE test standard J2723.

That brings us back to trust.

Chevrolet Performance has been designing, testing and building performance engines longer than anyone — and when it comes to parts and accessories, Chevrolet Performance is your factory source for everything from brand new engine blocks to performance accessories for Corvette, Silverado, Colorado and more.

That's experience you can trust — from Chevrolet Performance.



“ **Every stage of the process combines innovation, craftsmanship and an unwavering attention to detail fueled by our passion for performance.** ”



ENGINE DIMENSIONS

NOTE: Drawings may not reflect exact engine contents. See product pages or consult a dealer for details.

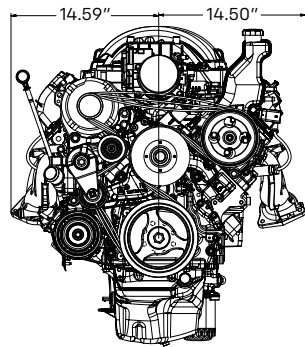

L8T/L8P

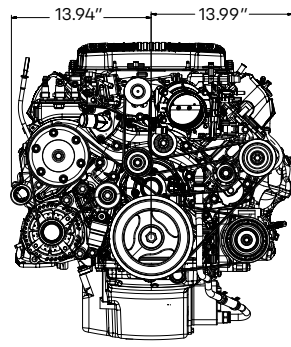

LT4

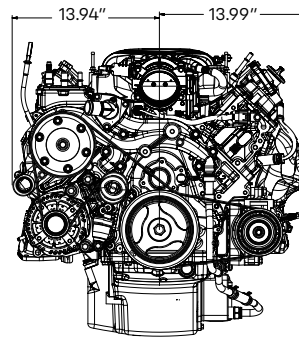

LT1

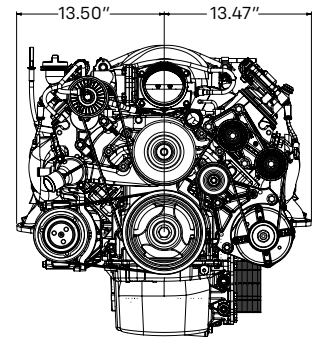

LS3

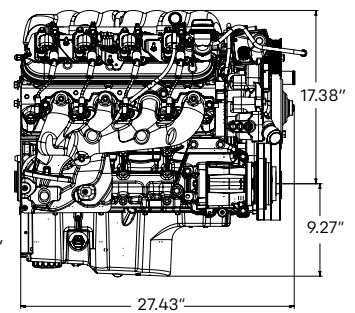
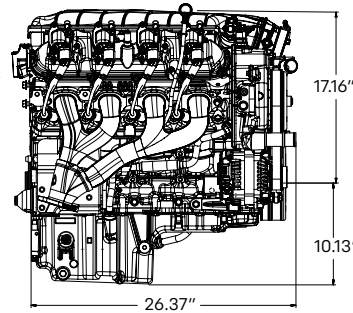
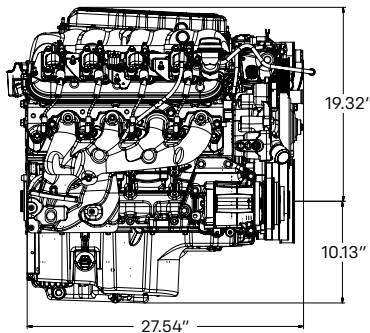
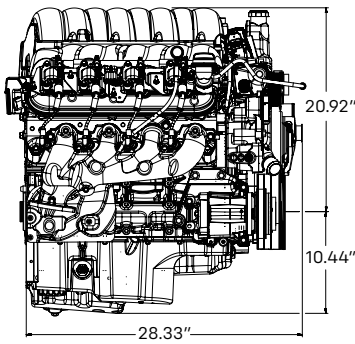

TRANSMISSION DIMENSIONS

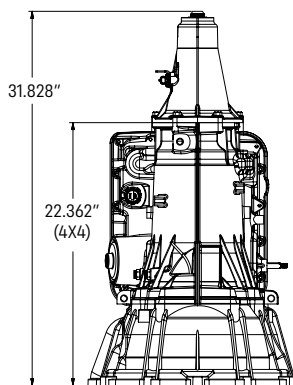

4L65-E/4L70-E/4L75-E

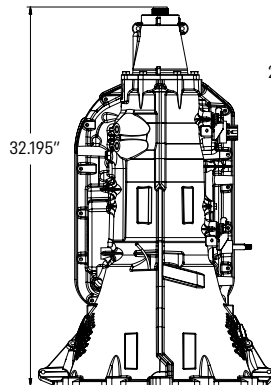

4L85-E

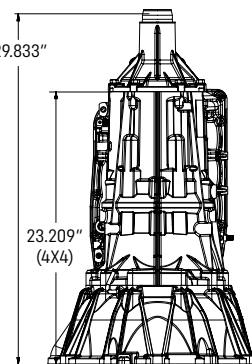

6L80-E

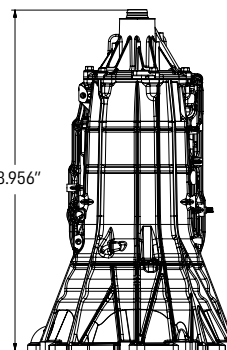

8L90-E

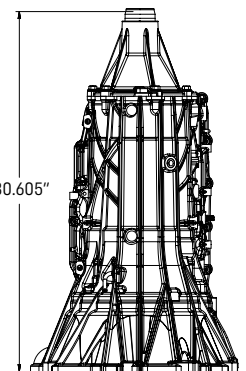

10L90-E

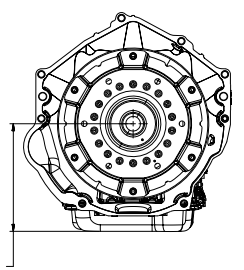
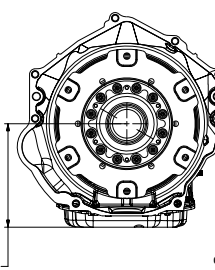
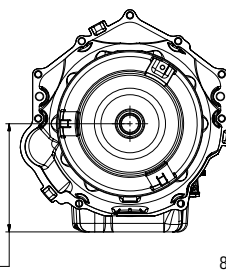
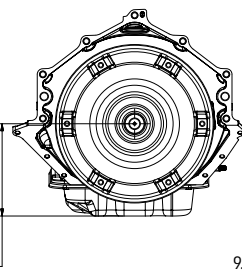
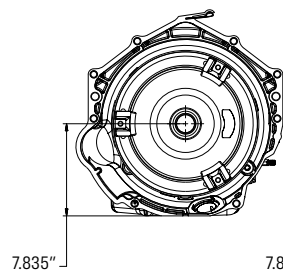



Performance Upgrades & Accessories

Personalized style and performance from Chevrolet!

With vehicle-specific portfolios ranging from capability enhancing off-road suspension upgrades to exhaust systems that add real horsepower, Chevrolet Performance offers Corvette, Camaro, Silverado, Colorado, Tahoe and Suburban owners everything they need to customize their vehicle for performance and style.

For full product portfolios, visit Chevy.com/Accessories to purchase or Chevrolet.com/Performance to find a dealer.



Corvette pg. 9



Camaro pg. 11



Silverado pg. 12-14



Tahoe & Suburban pg. 15



Colorado pg. 16-19



Corvette Stingray & Z06 Performance Upgrades

A. Engine Covers

- Enhance your mid-engine masterpiece with a stylish appearance upgrade
- One-piece engine cover, provides insulation while helping protect from dirt and debris
- 6.2L features a grained insert with embossed Corvette lettering
- 5.5L features the crossed flags logo



A

Part Number	Description
12697368	6.2L Engine Cover in Edge Red (not shown)
12697373	6.2L Engine Cover in Silver (not shown)
87858051	5.5L Engine Cover in Visible Carbon Fiber

B. Premium Indoor Car Cover

- Helps to protect the exterior surface of your vehicle from the elements
- Custom car cover designed for your vehicle
- For indoor use and protection against dust and debris
- Contains a layer of micro-porous film and an inner cotton layer for protection
- Includes storage bag



B

Part Number	Description
85734836	Fully Rendered Corvette GT3.R NEW!
85734837	Fully Rendered Corvette GT3.R for use with High Wing Spoiler NEW!
85112475	Fully Rendered Corvette C8.R in Gray
85159500	Fully Rendered Corvette C8.R in Yellow
85152655	Fully Rendered Corvette C8.R for use with High Wing Spoiler in Gray
85152654	Fully Rendered Corvette C8.R for use with High Wing Spoiler in Yellow

C. Jake Decal Package

- Enhance the exterior appearance of your Corvette with the Chevrolet Accessories Stingray R Graphics Package.
- This premium decal package is designed for application on the hood and sides of the vehicle, to give it a custom high-performance look.



C

Part Number	Description
84290339	Stingray R Graphics Package
84648690	Z06 Front Jake Logo Graphics Package in Carbon Flash Metallic
84648695	Z06 Rear Jake Logo Graphics Package in Carbon Flash Metallic
85641520	Stingray Front Hash Graphic in Tech Bronze
85641548	Stingray/Z06/E-Ray Jake Hood Graphic in Tech Bronze
85641579	Z06/E-Ray Jake C8.R Rear Hash Graphic in Tech Bronze

D. Performance Wheels

- Personalize your vehicle with these Chevrolet Accessories Wheels validated by GM specifications. Use only GM-approved wheel and tire combinations
- See Chevrolet.com/accessories for important wheel and tire information



D

Part Number	Description
85132780	Stingray Multi-Spoke Tech Bronze - 19" Front Wheels
85132782	Stingray Multi-Spoke Tech Bronze - 20" Rear Wheels
84334346	Z06 Spider-Design Tech Bronze - 20" Front Wheels
84334347	Z06 Spider-Design Tech Bronze - 21" Rear Wheels
85622293	Z06 Spider-Design Graphite with Red Stripe - 20" Front Wheels
85622294	Z06 Spider-Design Graphite with Red Stripe - 21" Rear Wheels
86774729	Stingray Bright Polished 15 Spoke - Selective Milled Aluminum Wheel - 19" Front Wheels
86774731	Stingray Bright Polished 15 Spoke - Selective Milled Aluminum Wheel - 20" Rear Wheels

NOTE: Center Caps, Tires, Lug Nuts, Tire Pressure Monitors and Wheel Locks may be sold separately. See your dealer for details.

Corvette Performance Upgrades continued

E. Engine Cross Brace-Visible Carbon Fiber with Jake Logo

84983921

- Enhances chassis stiffness
- Increases lateral stiffness up to 3.40%
- Contributes to a more direct steering response
- Made of Visible Carbon Fiber
- Features Corvette Jake logo
- Fasteners feature etched Crossed Flags logo



E

F. Emblems

- Add a personalized feel to your vehicle’s exterior
- Uses the same high-quality material as your production emblems
- Replaces factory emblems

Part Number	Description
84872169	Z06 Dark Stealth Crossed Flags Emblems in Carbon Flash Metallic – Coupe only
86563265	Z06 Dark Stealth Crossed Flags Emblems in Carbon Flash Metallic – Convertible only
84872163	Stingray/E-Ray Dark Stealth Crossed Flags Emblems in Carbon Flash Metallic
86526371	Z06/E-Ray Edge Red Corvette Script Emblem
86563278	Stingray Edge Red Corvette Script Emblem
86526362	Z06/E-Ray Torch Red Corvette Script Emblem
84313984	Stingray Torch Red Corvette Script Emblem
84517167	Z06/E-Ray Arctic White Corvette Script Emblem
84313984	Stingray Arctic White Corvette Script Emblem
85623536	Z06 Emblem in Edge Red
86563296	NEW! E-Ray Emblem in Rapid Blue with Carbon Flash Metallic



F

G. High Wing Spoiler

- Enhances the performance and intensifies the design of your vehicle
- Increases total downforce up to 25 lbs. of force at 180 MPH compared to Z51
- Available in Torch Red, Arctic White, Black and Carbon Flash Metallic
- Front splitter and ground effects kit sold separately
- Drilling and adhesive may be required (see your dealers for details)
- Stingray only

Part Number	Description
85001056	Torch Red
85001061	Arctic White
85001046	Black
85001066	Carbon Flash Metallic
85106905	Carbon Fiber High Wing Spoiler



G

H. Spoiler Extension, Clear Smoked Center Bridge with Jake Logo

85544887

- Enhance the performance and intensify the design of your vehicle
- Requires TOE production spoiler
- Includes all necessary hardware



H

2016-2024 Gen 6 Camaro Performance Upgrades

A. Front 6-Piston Brembo® Brake Upgrade System in

- Six-piston monoblock aluminum calipers with performance brake pads and two-piece, 14.6-inch x 1.3-inch (370mm x 34mm) vented and slotted Duralife™ rotors (cast-iron braking rings with aluminum hats)
- Duralife™ rotors feature a hardened surface to help reduce corrosion and provide quieter braking with less vibration
- Available for LS, LT and SS Camaro models without 1LE Package
- 4-Piston Brembo® Brake Calipers
- Color matched to pair with the Front 6-piston Brembo Brake Upgrade System
- Available for Camaro SS



Part Number	Description
84236462	Front 6-Piston Brembo® Brake Upgrade System in Red
84300395	Rear 4-Piston Brembo® Brake Calipers in Red

B. ZL1 1LE Spec Solid Cradle Bushings

84341929

- Constructed from 6061-T6 aluminum and machined from billet
- Replace your vehicle's standard rubber bushings
- Add rigidity while reducing suspension compliance for drag strip or track driving applications



C. Wicker Bill Spoiler Kit

84314076

- Enhances the look and performance of your vehicle
- Track tested and developed by Chevrolet engineers to increase rear downforce
- Requires Blade Spoiler Kit

Requires Blade Spoiler kit (sold separately). Available in Black (84314076), Red Hot (84016427), Summit White (84016431) or Riverside Blue (84016429)

D. Camaro SS Strut Tower Braces

- Increases strut tower lateral stiffness up to 47%
- Enhances chassis stiffness
- Contributes to a more direct steering response
- Built from lightweight 6061 T6 aluminum

Part Number	Description
84247228	6.2L Black Strut Tower Brace (Coupe and Convertible)
84125309	6.2L Aluminum Tower Brace (Camaro SS Coupe)



E. Calibrations

SS 1LE eLSD Calibration Upgrade (Dealer Install Only) 🏁

ZL1 1LE Automatic eLSD Calibration Upgrade (Dealer Install Only) 🏁

- Faster turn in and faster power application on turn exit
- Decouples the differential at a faster rate based on accelerator pedal position and steering wheel angle to enable faster yaw rotation at corner entry
- Faster coupling upon corner exit to enable power to be delivered sooner to both rear wheels

NOTE: This calibration is for road course purposes only. The ZL1 1LE Automatic Transmission eLSD Calibration will only be enabled when the vehicle is in Performance Traction Management ("PTM") enabled modes or in an Electronic Stability Control off state.

ZL1 eLSD Calibration (Dealer Install Only) 🏁

- Enables more consistent burnout performance for improved drag strip launches
- Doubles the differential coupling torque during burnout and drag launch scenarios by increasing the pressure applied to the clutch pack in order to prevent relative slip between the clutch plates
- As a result, burnouts warm both tires evenly

NOTE: This calibration is for drag racing purposes only. The eLSD Drag Performance Calibration will only be enabled when the vehicle is in Traction Control System Off.

NOTE: Driving vehicle on public roads with traction control system and electronic stability control system disabled is dangerous and not recommended for any operator.



Parts intended for competition use only. See page 2 for details.



Performance

Silverado 1500 Performance Upgrades

A. Off-Road Recovery Kit

84949369

- Be prepared with this Chevrolet Accessories Off-Road Recovery Kit
- Kit includes essential items to keep in your vehicle during off-road adventures
- Packaged in a convenient storage bag with the Chevrolet Bowtie logo
- Includes a 29.5-ft. recovery strap (tested to provide up to 24,250 lbs. of recovery strength), two bow shackles (each tested to provide up to 10,500 lbs. of recovery strength), gloves, and a recovery tarp



A

B. ZR2 Spec Front/Rear DSSV Shock System

85640298

- The ZR2 Spec 40mm Multimatic DSSV Shock System employs spool valve technology and offers increased precision for enhanced ride and handling performance both on- and off-road
- Provides up to a 2-inch increase in front suspension travel and up to a 1-inch increase in rear suspension travel
- Installation by an authorized dealer is recommended

Compatible with 2019+ Silverado Trail Boss models or vehicles equipped with the Performance 2-Inch Suspension Lift Kit (sold separately).



B

C. Steel Driveshaft

84861275

- Chevrolet Performance Steel Driveshaft offers resistance to impact damage in off-road conditions
- This 3.5-inch diameter steel driveshaft allows for increased clearance over obstacles, has a maximum driveshaft speed of 4,391 RPM
- Comes assembled with 1350 U-Joints and includes all required fasteners
- Designed for use on 2019+ Gas SWB 4WD Silverado only



C

D. 2" Suspension Lift Kit

- Developed by the same vehicle-level engineers who built the truck; the system was tested under the same grueling conditions
- Front and rear passive monotube dampers specifically tuned to the chassis
- Includes an exclusive dealer-installed Front Camera Reconfiguration and Electronic Power Steering calibration so that all driver-assist systems can continue to function seamlessly
- Read the vehicle owner's manual for important driver-assist system feature limitations and information
- The Steel Leaf Spring Kit is required to support the installation of the Chevrolet Performance 2-Inch Lift Kit on MY2019+ L84 (5.3L V8) LT Trim and MY2019+ LM2 (3.0L Turbo Diesel) 2WD, Crew Cab and Short Bed LT Trim equipped trucks



D

Part Number	Description
85040013	4WD 2" Suspension Lift Kit
84993583	2WD 2" Suspension Lift Kit
84768245	Steel Leaf Spring Kit

E. Functional Beadlock Ring Kit

85063156

- Enables the OEM tire's bead to be secured outside the rim to run low air pressures for off-road applications
- Forged aluminum w/ a machined finish
- Professional installation recommended
- Designed to be used with OEM beadlock capable wheels. See dealer for details
- 10-year corrosion limited warranty



E

F. Front and Rear 4-Corner Brake Upgrade

FRONT

- 410mm x 32mm (16.1-inch x 1.3-inch) Duralife™ rotors
- Hardened rotor surface to reduce corrosion and provide quieter braking with less vibration
- Bright Red Chevrolet Performance Brembo® 6-piston fixed aluminum calipers
- 22% increase in rotor area over stock
- 89% increase in brake pad area to increase system thermal capacity

REAR:

- Designed to complement the Front Big Brake System
- Maintains complete integration and works seamlessly with the vehicle's brake system



F

Part Number	Description
85138043/85521913	Front 6-Piston/Rear - 2019-2024
86560478/85521923	Front 6-Piston/Rear - 2025+

G. ZR2 Spec Underbody Shield

84962765

- Specifically engineered to fit and help protect your vehicle's underbody
- Designed for on-road and off-road use, helping to provide protection in extreme conditions
- Underbody skid is 5000 series aluminum
- Transfer case skid is made of steel



G

H. Exhaust Tip – Polished

- Add a sporty appearance to the exterior of your vehicle with this Chevrolet Performance Exhaust Tip
- This 4" Tip features the Bowtie logo for a personalized touch.

Part Number	Description
84722771	4.3L and 5.3L Dual Wall Angle Cut Exhaust Tip with Bowtie Logo
84722774	2.7L Dual Wall Angle Cut Exhaust Tip with Bowtie Logo
84722777	3.0L Diesel Dual Wall Angle Cut Exhaust Tip No Logo



H

I. Exhaust Tip – Black Chrome

- Proven through on-vehicle testing under maximum payload, operating temperatures of over 572°F and extreme corrosion chamber testing equivalent to 5 years, and a 2-hour thermal heat soak at ~392°F
- Validated to resist corrosion and discoloration while maintaining the New Vehicle Limited Warranty

Part Number	Description
84521821	2.7L Dual Wall Angle Cut Exhaust Tip with Bowtie Logo
84521819	5.3L and 4.3L Dual Wall Angle Cut Exhaust Tip with Bowtie Logo
84520927	3.0L Diesel Dual Wall Angle Cut Exhaust Tip No Logo



I

PERFORMANCE UPGRADES & ACCESSORIES

Silverado 1500 Performance Upgrades continued

J. Exhaust Bezels in Black

85084203

- Built from 304 stainless steel with a black chrome coating
- Proven through on-vehicle testing under maximum payload, operating temperatures of over 572°F and extreme corrosion chamber testing equivalent to 5 years, and a 2-hour thermal heat soak at ~392°F
- Validated to resist corrosion and discoloration while maintaining the New Vehicle Limited Warranty
- Compatible with dual rear-exit configurations



J

K. Exhaust Upgrade Systems

- Bolt-on cat-back system
- Fabricated with premium 304 stainless steel for improved corrosion protection
- No calibration needed
- Available in single side-exit and dual rear-exit configurations

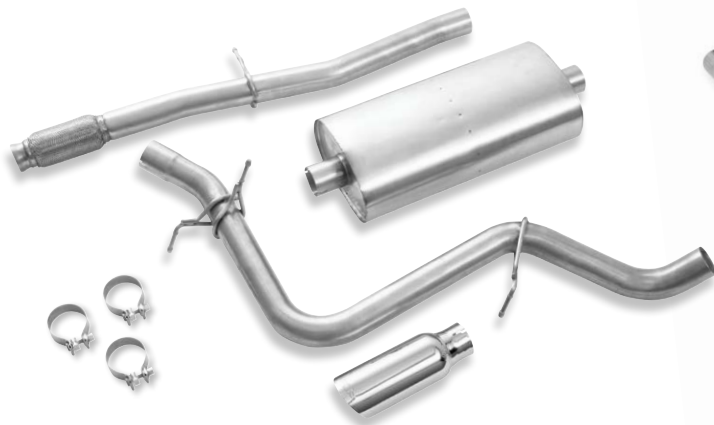

K

Part Number	Description
84964744	6.2L Dual Exit Exhaust Upgrade System (Crew Cab Short Box & Double Cab Standard Box) - 2019-2023
84964743	6.2L Dual Exit Exhaust Upgrade System (Crew Cab Standard Box) - 2019-2023
84964739	5.3L Dual Exit Exhaust Upgrade System (Crew Cab Short Box & Double Cab Standard Box)
84964740	5.3L Dual Exit Exhaust Upgrade System (Crew Cab Standard Box)
84964738	5.3L Single Exit Exhaust Upgrade System with Polished Tip and Bowtie Logo (Crew Cab Short Box & Double Cab Standard Box)
84964737	5.3L Single Exit Exhaust Upgrade System with Polished Tip and Bowtie Logo (Crew Cab Standard Box)
87816783	6.2L Dual Exit Exhaust Upgrade System (Crew Cab, Short Box) - MY2022 & 2023 ZR2 only

Description	Horsepower Gain	Torque Gain	Backpressure Reduction
6.2L V8 Dual Exit Exhaust System	Up to 13 hp	8 lb.-ft.	Up to 40%
5.3L V8 Dual Exit Exhaust System	Up to 10 hp	6 lb.-ft.	Up to 41%
5.3L V8 Single Exit Exhaust System	Up to 7 hp	4 lb.-ft.	Up to 35%

Tahoe/Suburban Performance Upgrades

A. Front and Rear 4-Corner Brake Upgrade

FRONT:

- Front 6-piston Brembo® calipers in red feature the Chevrolet Performance logo
- Duralife™ rotors feature a 22% increase in rotor area over stock rotors, with a hardened surface to help reduce corrosion and vibration
- Brake pad area is increased by 89% over stock for increased system thermal capacity

REAR:

- Color-matched rear calipers designed to complement the Front Big Brake System
- Maintains complete integration
- Works seamlessly with the production parking brake system



Part Number	Description
85138043/85521918	Front 6-Piston/Rear - 2019-2024
86560478/85521923	Front 6-Piston/Rear 2025+

A

B. Exhaust Upgrade System

- Bolt-on cat-back system
- Fabricated with premium 304 stainless steel for corrosion protection
- No calibration needed
- Available in single side-exit and dual rear-exit configurations

Part Number	Description
84888291	Tahoe 6.2L Dual Exit Exhaust Upgrade System
84888292	Suburban 6.2L Dual Exit Exhaust Upgrade System
84460758	Tahoe 5.3L Dual Exit Exhaust Upgrade System
84488076	Suburban 5.3L Dual Exit Exhaust Upgrade System
84460752	Tahoe 5.3L Single Exit Exhaust Upgrade System with Polished Tip and Bowtie Logo
84460753	Suburban 5.3L Single Exit Exhaust Upgrade System with Polished Tip and Bowtie Logo

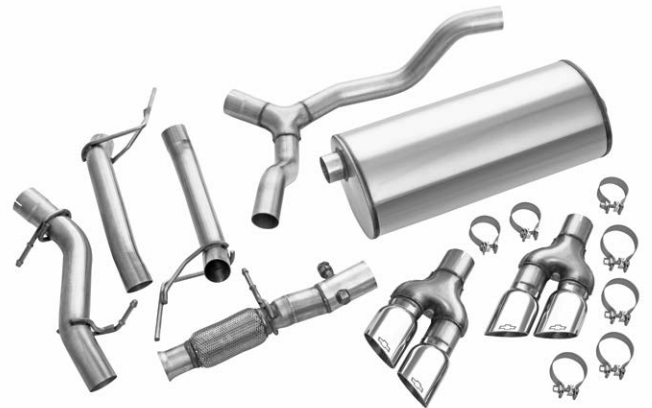

B

Description	Horsepower Gain	Torque Gain	Backpressure Reduction
6.2L V8 Dual Exit Exhaust System	Up to 11 hp	6 lb.-ft.	Up to 30%
5.3L V8 Single Exit Exhaust System	Up to 7 hp	4 lb.-ft.	Up to 30%
5.3L V8 Dual Exit Exhaust System	Up to 4 hp	2 lb.-ft.	Up to 19%

C. Exhaust Tips

- Available in multiple finishes for a personalized touch
- Adds a sporty appearance to the exterior of your vehicle
- Dual-wall angle-cut design

Part Number	Description
84513870	5.3L Black Chrome
84439200	5.3L Polished Stainless
84513857	5.3L Carbon Fiber
84513872	3.0L Diesel Black Chrome Stainless Steel Exhaust Tip
84524664	3.0L Diesel Polished Stainless Steel Exhaust Tip
84513865	3.0L Diesel Carbon Fiber Exhaust Tip



C

2023+ Colorado Performance Upgrades

A. Off-Road Recovery Kit

84949369

- Be prepared with this Chevrolet Accessories Off-Road Recovery Kit
- This kit includes essential items to keep in your vehicle when out adventuring off-road
- Packaged in a convenient storage bag with the Chevrolet Bowtie logo
- Includes a 29.5-ft. recovery strap (tested to provide up to 24,250 lbs. of recovery strength), two bow shackles (each tested to provide up to 10,500 lbs. of recovery strength), gloves, and a recovery tarp



A

B. Winch and Controller by COMEUP **NEW!**

- Requires the Accessory Auxiliary Control Switches (sold separately)

Part Number	Description
19433054	For Off-Road Bumper - Only compatible with the Off-Road Stainless Steel Front Bumper with Grille Guard
19435837	For AEV Bumper - Only compatible with vehicles originally equipped with the AEV stamped-steel front bumper



B

C. ZR2 Spec Underbody Shield

- Specifically engineered to fit and help protect your vehicle's underbody
- Designed for on-road and off-road use, helping to provide protection in extreme conditions
- 5000 series aluminum construction

Part Number	Description
83027956	Front Underbody Shield
84913729	Mid Underbody Shield - includes Steering Gear

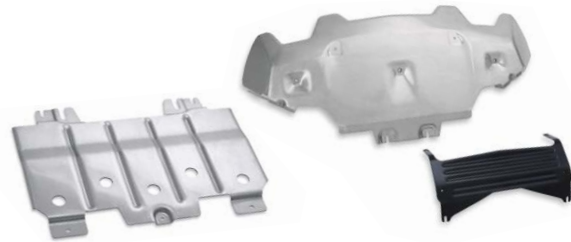

C

D. Jounce Control Dampers

85063153

- Fully integrated kit developed to be paired with Multimatic DSSV™
- Shocks includes front and rear bolt-on systems, jounce control dampers for each side, crossmember, front damper spacer, rear leaf spring spacer and all required fasteners
- Developed for off-road racing and rock crawling
- 29.1mm front shock travel and 76.2mm rear shock travel
- Provides a 12mm lift
- Compatible with MY2024+ Colorado ZR2 only



D

E. Steel Driveshaft

84855639

- Designed to provide enhanced resistance to impact damage in off-road conditions with a Chevrolet Performance Steel Driveshaft
- A 3.5-inch diameter shaft allows for increased clearance over obstacles during extreme off-road and rock crawling events
- This driveshaft comes assembled with 1350 U-Joints
- Installation by an authorized dealer is recommended
- Compatible with 4WD trucks. Includes steel driveshaft and all required fasteners



E

F. 1.5" Suspension Lift Kit

84914657

- Helps improve off-road performance by increasing approach, breakover and departure angles
- Maintains available driver assist features including Forward Collision Alert*, Lane Departure Warning* and Rear Park Assist*
- Expert installation by an authorized GM Dealer is recommended
- Will not void the New Vehicle Limited Warranty
- See dealer for restrictions

*Safety or driver assistance features are no substitute for the driver's responsibility to operate the vehicle in a safe manner. Read the vehicle's owner's manual for important feature limitations and information.



F

G. Beadlock Capable Wheel

- Available in multiple colors for a personalized touch
- Adds an Off-Road appearance to the exterior of your vehicle
- Forged aluminum w/ a machined finish
- Enables use of functional beadlock ring kit

Part Number	Description
84605401	17" wheel with argent metallic decorative ring
84605398	17" wheel with tech bronze decorative ring

H. Functional Beadlock Ring Kit

84605397

- Enables the OEM tire's bead to be secured outside the rim to run low air pressures for off-road applications
- Forged aluminum w/ a machined finish
- Professional installation recommended
- Designed to be used with OEM beadlock capable wheels. See dealer for details
- 10-year corrosion limited warranty

I. Exhaust Tip

- Available in multiple finishes for a personalized touch
- Adds a sporty appearance to the exterior of your vehicle
- Dual-wall angle-cut design with embossed logo
- Featuring bowtie logo

Part Number	Description
84894460	Polished
84894462	Black Chrome

J. Engine Air Intake Snorkel Kit by AEV **NEW!**

19434679

- The snorkel is designed to help improve engine performance by drawing in the coolest, cleanest air possible
- Tested extensively in tough real-world conditions, the lightweight yet durable Snorkel Kit directs air into your vehicle's factory airbox.
- Includes all mounting hardware. Non-GM warranty. Limited warranty by AEV 3 years/36,000 miles (whichever occurs first)

K. Removable Off-Road Assist Steps **NEW!**

- Make it easier to get into and out of your vehicle
- They attach to the Chevrolet Accessories Rocker Protectors P/N 86528352 (sold separately/standard on ZR2 & ZR2 Bison)
- For owners looking to enhance entry/egress during everyday driving
- Feature a textured step surface for additional traction
- When off-roading, these steps can be removed to help prevent damage and add ground clearance
- Includes two front removable assist steps and attachment kit with four bolts and four U-nuts

Part Number	Description
84808889	Front
85158582	Rear

L. L3B Engine Calibration

86577457

- Increases the Torque Output of the engine by 40 foot pounds
- Does not require premium fuel
- Maintains all vehicle limited warranties
- Dealer installation required
- Available for MY2023 WT, LT, Trail Boss & Z71 only



G



H

I



J



K

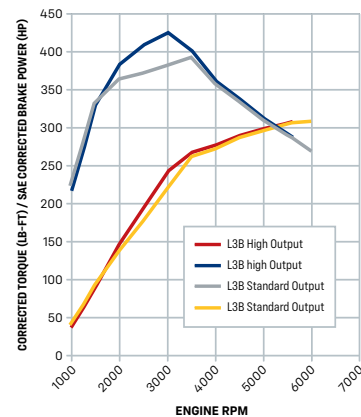

L



Parts intended for competition use only. See page 2 for details.



Performance

2018–2022 Colorado ZR2

Desert-tough to dust the competition



A lineup of true factory off-road racing parts¹ is ready to elevate the capabilities of the 2018–2022 Colorado ZR2 even further. The outcome of decades of off-road racing expertise, they're developed by engineers and racers as passionate about performance as you are. Over 10,000 combined off-road race and development miles are proof that the Hall Racing Chevrolet Colorado ZR2—and the Chevrolet Performance Parts that power it—have made the grade.

Front and Rear Jounce Shock Systems

Front and Rear Jounce Shock Systems (front and rear systems sold separately) incorporate nitrogen-charged hydraulic secondary suspension bump shocks developed for off-road racing and rock crawling. They greatly enhance gross vehicle motion control, increase suspension capacity and provide exponential bottoming protection for extreme off-road conditions. Separate front and rear bolt-on systems include Jounce Shocks for each side, required mounting brackets and all required fasteners.



Rear Jounce Shock System - Requires Jounce Striker/Leaf Spring Mount System (P/N 84422116), available separately. Chevrolet Performance recommends pairing with the Cross-Car Beam System (P/N 84403779) for all V6-equipped off-road application.

Part Number	Description
87846332	Front
84422546	Rear

ZR2 Anti-Wrap Link System

84402369

The Anti-Wrap Bar System helps prevent axle wrap under acceleration and braking while improving suspension control in extreme off-road conditions. This system is a direct bolt-on to V6-equipped MY2018+ Colorado ZR2 models intended exclusively for off-road use and includes the front frame attachment, anti-wrap bar with bushing and sealed rod end bearing, a differential cover bracket and all necessary mounting fasteners.



Requires the additional Rear Differential Cover (P/N 84401895) and Long Travel Rear Leaf Spring System (P/N 84402368).

Front Leveling Kit with High-Angle Upper Control Arms

85539389

Increases front ride height by up to 1.25 inches, levels vehicle stance and provides a greater approach angle, all of which helps enable the use of popular off-road tire combinations². High-angle upper control arms maintain optimal joint articulation for increased front suspension travel, and upgraded ball joints increase cross-car articulation by up to 18%. The sealed ball joint and boot design based on Chevrolet Performance standards provides a protected environment from off-road elements. This system provides additional integration with the DSSV dampers to help maintain the factory stock ZR2 ride quality.



Not compatible with ZR2 Front Long Travel DSSV Shocks (P/N 85143349). Chevrolet Performance recommends pairing with Ball Spline Half Shafts (P/N 86820634), Front Jounce Shock System (P/N 87846332) and Tie Rod Sleeve System (P/N 84419134).

ZR2 High-Angle Upper Control Arm Ball Joint System

85539384

The High-Angle Upper Control Arm Ball Joint System enables increased upper ball joint articulation, which enables increased front suspension travel. A direct replacement for the production unit, the high-angle joint system increases cross-car articulation by up to 18% and features a sealed ball joint design and boot design based on Chevrolet Performance standards, providing a protected environment from off-road elements.



¹ The Chevrolet Performance ZR2 Off-Road Performance Parts listed here are intended for off-road use.

² Use only GM-approved tire and wheel combinations. See chevrolet.com/accessories for important wheel and tire information, or see your dealer.

Dominate the desert.

Chevrolet Performance ZR2 Off-Road Performance Parts¹ upgrade the already-rugged driveline and suspension systems of Colorado to help handle the extreme, high-speed demands of desert racing.

ZR2 1.5-Inch Body Lift System

85153752

The ZR2 1.5-inch Body Lift System increases front and rear fender clearance, enabling the use of popular off-road tire options. The system is a direct bolt-on for MY2018+ Colorado ZR2 V6 models intended exclusively for off-road use.



ZR2 Ball Spline Half Shafts

86820634

Fixed Double Offset Joint Ball Spline Half Shafts allow for larger joint angles compared to production ZR2 half shafts, accommodating lifted or leveled MY2018+ Colorado ZR2 models intended exclusively for off-road use. Featuring fixed inner and outer joints, and center bar plunging, these half shafts provide improved articulation while reducing feedback forces through the steering system during hard cornering. The system includes Ball Spline Half Shafts and wheel nuts.



ZR2 Cross-Car Beam System

84403779

This system helps counteract loads from the ZR2 Rear Jounce Shock System. Recommended for pairing with the ZR2 Rear Jounce Shock System (P/N 84422546), the system includes the beam assembly, end plates and required fasteners. Not available for diesel ZR2 models.



ZR2 Steel Driveshaft

84401894

The Steel Driveshaft offers resistance to impact damage in off-road conditions. The 3.5-inch diameter steel shaft allows for increased clearance over obstacles and improves packaging with additional and optional off-road suspension components. The steel shaft comes assembled with 1350 U-Joints and has a maximum driveshaft speed of 5000 rpm.



ZR2 Long Travel Leaf Spring System

84402368

The Chevrolet Performance ZR2 Long Travel Leaf Spring System is an optimized single-rate leaf spring that replaces the stock ZR2 Dual-Rate Spring. The spring design relocates the rear axle for a better system-directed path of the rear tire to center in the rear wheelhouse in extreme travel conditions. The spring system also increases the rear ride height approximately 30mm to allow for a typical off-road payload to be carried during off-road events. Overall suspension travel is increased up to 11" when paired with Long Travel Rear DSSV shocks, P/N 84402367. A direct bolt-on, the system includes both rear leaf springs, longer off-road shackles and all mounting fasteners.



Chevrolet Performance recommends use with the Jounce Striker/Leaf Spring Mount System (P/N 84422116), Long Travel Rear DSSV Shocks (P/N 84402367), Anti-Wrap Link System (P/N 84402369), and Rear Jounce Shock System (P/N 84422546) for optimum off-road performance.

ZR2 Front and Rear Long-Travel DSSV Shocks

The Chevrolet Performance ZR2 Front Long Travel Dynamic Suspension Spool Valve (DSSV) Shocks are designed and tuned specifically for off-road racing by Chevrolet Performance and Multimatic. They provide up to a 15% increase in overall suspension travel on MY2018+ Colorado ZR2 models. Enhancements from stock ZR2 DSSV Shocks include an 18mm diameter rod to accommodate higher side load, advanced design seals to handle high shock temperatures, solid Heim joint lower mount and optimized Spool Valve tuning. The system includes both front shocks, top mounts with rate washers, upper spring seats and all required mounting fasteners. Chevrolet Performance ZR2 Rear Long Travel Dynamic Suspension Spool Valve (DSSV) Shocks are designed and tuned specifically for off-road racing by Chevrolet Performance and Multimatic. They provide up to a 10% increase in overall rear suspension travel on MY2018+ Colorado ZR2 models and feature a 16mm diameter rod for higher side load, advanced design seals to handle high shock temperatures and optimized Spool Valve tuning. Includes both rear shocks and all required mounting fasteners.



The front system requires the High-Angle Upper Control Arm Ball Joint System (84402363). Chevrolet Performance recommends use with the Plunging Ball Spline Half Shaft System (86820634) and Front Jounce Shock System (87846332) for optimum off-road performance.

NOTE: The front system does not include springs. Chevrolet Performance recommends the use of a flat ground coil over type 3" ID spring, 14" in length, with two optional rates, 650 lbs/in or 700 lbs/in.

Part Number	Description
85143349	Front
85143352	Rear

ZR2 Heavy Duty Tie Rod Sleeves

84419134

Chevrolet Performance ZR2 Tie Rod Sleeve System provides an effective solution to help increase buckling strength for severe duty, off-road, and race conditions while maintaining the stock tie rods. Tested and validated in extreme off-road races, the Tie Rod Sleeve System is a proven addition to the ZR2.



ZR2 Rear Differential Cover

84401895

The Rear Differential Cover's precision-machined 6061-T6 aluminum billet construction offers robust mounting attachments for the Anti-Wrap Link System. Features a clear-anodized machined billet exterior, unique Chevrolet Performance logo plate and includes installation hardware. Can be used with the optional Anti-Wrap Bar System (P/N 84402369) or alone.



chevrolet.com/performance/colorado/off-road

¹The Chevrolet Performance ZR2 Off-Road Performance Parts listed here are intended for off-road use.



Transmissions and Components

Factory-Matched Choices for Chevrolet Performance Crate Engines

Selecting a strong, durable transmission to complement your high-performance crate engine is easy with Chevrolet Performance's range of factory-engineered transmissions, installation kits and components.

Each transmission kit is engineered with factory-matched torque capacity ratings, helping ensure the transmission you purchase will stand up to the power of your engine—and every Chevrolet Performance automatic transmission is backed by a 12-month limited warranty.

The transmission lineup also includes manual gearboxes, including kits that adapt our modern six-speed transmission kits to all Chevrolet Performance engine families.

Our transmission controller kits complement the transmissions with quick plug-and-play operation.

IMPORTANT! Chevrolet Performance does not include a torque converter with four-speed automatic transmissions. A variety of torque converters for 4L60- and 4L80-series transmissions tailored for the wide variety of our crate engines' performance specifications are available. Select the transmission that's just right for your project and select the torque converter to match its performance. See page 22 for more details.

NOTE: Chevrolet Performance's electronically controlled transmissions are not compatible with the mechanical speedometers in older vehicles. An aftermarket signal converter or electronically compatible replacement speedometer is required.

SUPERMATIC™ TRANSMISSION FAMILIES

Chevrolet Performance's SuperMatic™ automatic transmission families include the 4L60-E and 4L80-E series of four-speed transmissions, along with the 6L80-E six-speed, 8L90-E eight-speed, and 10L90-E 10-speed transmissions. All electronically controlled.

4L60-E Series

The 4L60/4L65/4L70/4L75 series is differentiated primarily by gearset design and torque capacity. The planetary gearset of the 4L60-E has four pinion gears, while the 4L65-E, 4L70-E and 4L75-E have five pinion gears. The external dimensions and mounting provisions are identical for each version. The maximum torque capacity for each includes:

4L60-E – 380 lb.-ft. | 4L65-E – 430 lb.-ft.

4L70-E – 495 lb.-ft. | 4L75-E – 650 lb.-ft.

NOTE: Chevrolet Performance does not sell a 4L60-E transmission

4L80-E Series

The Hydra-Matic 4L80 and SuperMatic™ 4L85-E series is differentiated primarily by gearset design and torque capacity. The planetary gearset of the 4L80-E has four pinion gears, while the 4L85-E has five pinion gears. The external dimensions and mounting provisions are identical for each version. The maximum torque capacity for each includes:

4L80-E – 440 lb.-ft. | 4L85-E – 685 lb.-ft.

NOTE: Chevrolet Performance does not sell a 4L80-E transmission

6L80-E Series

The 6L80-E is based on the design offered in a number of rear-wheel-drive production vehicles, but enhanced with specific internal components that contribute to a higher torque rating of 650 lb.-ft. Designed for use in LS and LT based engines in both 2WD and 4WD applications, this electro-hydraulically controlled transmission has a modular arrangement that represents a significant departure in the design and operation from other transmissions such as the 4L60E and 4L80-E Series, including clutch-to-clutch shift operations rather than conventional bands. The SuperMatic™ 6L80-E is unique in that the transmission controller is internal. The transmission kit includes a torque converter, with a choice of two stall speeds. Also included are the wire harness, vent tube and oil cooler line adapter. A laptop connection and software allow the transmission to be configured for optimal performance and drivability.

8L90-E & 10L90-E Series

Chevrolet Performance adapted the production-based 8L90-E eight-speed and 10L90-E ten-speed automatic transmissions for use with our LT-series crate engines. Each feature four gearsets and five (8L90-E) or six (10L90-E) clutches plus creative packaging designs that enable these advanced automatics to fit the same approximate space as GM's family of six-speed automatics. Extensive use of aluminum and even magnesium make it lightweight, too. A torque converter and controller are included with each transmission and the kit is calibrated for the respective engine it is matched with in the powertrain.

NOTE: Chevrolet Performance four-speed and eight-speed automatic transmissions are remanufactured to General Motors' specifications. Chevrolet Performance six-speed and ten-speed automatic transmissions and six-speed manual transmissions are brand new.

The majority of components in Chevrolet Performance transmissions are new. In some cases, individual components are no longer manufactured by General Motors. In these few cases, reclaimed components are rebuilt to perform to General Motors' specifications and high quality standards.

NOTE: Chevrolet Performance SuperMatic™ Transmissions may not be compatible with production vehicles and should not be used as service transmission components.



*Shown from top:
Super Magnum Six-Speed Manual,
SuperMatic™ 6L80-E Six-Speed Automatic,
SuperMatic™ 10L90-E Ten-Speed Automatic*

PERFORMANCE SUPERMATIC™ TORQUE CONVERTERS

The SuperMatic™ Torque Converters from Chevrolet Performance are designed to provide long life when matched with a SuperMatic™ Transmission. Each converter incorporates the following features:

- Steel billet front cover
- Custom stator
- Fully furnace-brazed pump and turbine
- Designed for Chevrolet Performance crate engines and automatic transmissions
- "Heavy-duty" lock-up clutch
- All internal components static balanced
- Fully vector balanced as an assembly
- No external adapters needed to fit Chevrolet Performance crate engines



NOTE: Must use 14-inch (168-tooth) flexplate with SuperMatic™ torque converters unless noted.

Part Number	Stall Range	Application
19299800	2,400–2,800 rpm stall	4L60/65/70/75-E (late "LS" V-8 transmission) mate to early Gen 1 SB/BB (dual bolt pattern – 10.75" and 11.5")
19299801	3,000–3,400 rpm stall	4L60/65/70/75-E (late "LS" V-8 transmission) mate to early Gen 1 SB/BB (dual bolt pattern – 10.75" and 11.5")
19299802	2,400–2,800 rpm stall	4L60/65/70/75-E (late "LS" V-8 transmission) mate to LS V-8 engine (single bolt pattern – 11.062")
19299803	3,000–3,400 rpm stall	4L60/65/70/75-E (late "LS" V-8 transmission) mate to LS V-8 engine (single bolt pattern – 11.062")
19299804	2,400–2,800 rpm stall	4L80-E/4L85-E – mate to early Gen 1 SB/BB (dual bolt pattern – 10.75" and 11.5")
19299805	3,000–3,400 rpm stall	4L80-E/4L85-E – mate to early Gen 1 SB/BB (dual bolt pattern – 10.75" and 11.5")
19299806	2,400–2,800 rpm stall	4L80-E/4L85-E – mate to LS V-8 engine (extended pilot, single bolt pattern – 11.062")
19299807	3,000–3,400 rpm stall	4L80-E/4L85-E – mate to LS V-8 engine (extended pilot, single bolt pattern – 11.062")
19431972	2,400–2,800 rpm stall	6L80-E – mate to LS V8 engine (extended pilot, single bolt pattern – 281mm)
19431974	3,000–3,400 rpm stall	6L80-E – mate to LS V8 engine (extended pilot, single bolt pattern – 281mm)

Converters are a kit that includes converter-to-flexplate bolts and instructions.

BUILDER'S TIP

Slip Yoke Sizing

Installation of a Chevrolet Performance automatic transmission may require a new driveshaft. There are online resources to help determine the proper measurements for the length of the new driveshaft, but the manufacturer will also need to know the details for the slip yoke—the splined receiver at the front of the driveshaft that slides on to the output shaft of the transmission. Generally, they'll need the shaft diameter (also known as the barrel or seal diameter) and spline count for it. Here are the specs for Chevrolet Performance's automatic transmissions.

Transmission	Shaft Diameter	Spline Count
4L65-E, 4L70-E and 4L75-E	1.176-in.	27-spline
4L85-E	1.886-in.	32-spline
6L80-E	1.886-in.	32-spline
8L90-E*	1.886-in.	internal 32-spline
10L90-E	1.886-in.	32-spline
6-Speed Manual	N/A	26-spline input, 31-spline output

*Chevrolet Performance includes the yoke with this transmission.



Torque Converter Quick Reference Chart

Automatic Transmission Torque Converter Match Listing

Engine P/N	Description	Displac.	hp	Torque	4L60 Family		4L80 Family	
					Fits SuperMatic™ 4L65-E, 4L70-E (LS bell) and 4L75-E		Fits SuperMatic™ 4L85-E	
					Converter P/N	Stall Range	Converter P/N	Stall Range

Chevy Small-Block V-8

19433031	350 HO Turn-Key	350 cu in	333	381	19299800	2,400–2,800	N/A	N/A
19433038	350 HO Deluxe	350 cu in	333	381	19299800	2,400–2,800	N/A	N/A
19433030	350 HO Base	350 cu in	333	381	19299800	2,400–2,800	N/A	N/A
19433032	SP350/357 Base	350 cu in	357	407	19299800	2,400–2,800	19299804	2,400–2,800
19433033	SP350/357 Deluxe	350 cu in	357	407	19299800	2,400–2,800	19299804	2,400–2,800
19433034	SP350/357 Turn-Key	350 cu in	357	407	19299800	2,400–2,800	19299804	2,400–2,800
19433039	SP350/385 Base	350 cu in	385	405	19299801	3,000–3,400	19299805	3,000–3,400
19433040	SP350/385 Turn-Key	350 cu in	385	405	19299801	3,000–3,400	19299805	3,000–3,400
19433041	ZZ6 Base	350 cu in	405	406	19299801	3,000–3,400	19299805	3,000–3,400
19433042	ZZ6 Turn-Key	350 cu in	405	406	19299801	3,000–3,400	19299805	3,000–3,400
19433043	ZZ6 EFI Deluxe	350 cu in	420	408	19299801	3,000–3,400	19299805	3,000–3,400
19433044	ZZ6 EFI Turn-Key	350 cu in	420	408	19299801	3,000–3,400	19299805	3,000–3,400
19433036	HT383	383 cu in	323	444	19299800	2,400–2,800	19299804	2,400–2,800
19433035	SP383 Deluxe	383 cu in	435	445	19299801	3,000–3,400	19299805	3,000–3,400
19433045	SP383 EFI Deluxe	383 cu in	450	436	19299800	2,400–2,800	19299804	2,400–2,800
19433046	SP383 EFI Turn-Key	383 cu in	450	436	19299800	2,400–2,800	19299804	2,400–2,800

Chevy LS/LT/LSX V-8

19540155	LS3 6.2L	6.2L	430	425	19299802	2,400–2,800	19299806	2,400–2,800
19421057	LS3 6.2L – E-ROD Kit Automatic	6.2L	430	425	19299802	2,400–2,800	19299806	2,400–2,800
19540156	LS376/480	6.2L	495	473	19299803	3,000–3,400	19299807	3,000–3,400
19540157	LS376/525	6.2L	525	486	19299803	3,000–3,400	19299807	3,000–3,400
19434599	DR525 with Gen IV F car oil pan	6.2L	525	498	N/A	N/A	N/A	N/A
19434600	DR525 with muscle car oil pan	6.2L	525	494	N/A	N/A	N/A	N/A
19432776	LSX376-B8	6.2L	476	475	19299802	2,400–2,800	19299806	2,400–2,800
19417356	LSX376-B15	6.2L	473	444	N/A	N/A	N/A	N/A
19417357	LSX454 (with 4L75-E)	7.4L	627	586	19299803	3,000–3,400	19299807	3,000–3,400
19431953	LT1 6.2L with wet sump	6.2L	455	455	19299802	N/A	19299802	N/A
19433063	LT1 – E-ROD with wet sump (w/4L70-E)	6.2L	455	455	19299802	2,400–2,800	N/A	N/A
19431955	LT4 6.2L SC with wet sump	6.2L	650	650	19299802	2,400–2,800	24290217	N/A
19433071	LT4 – E-ROD with wet sump (w/4L75-E)	6.2L	650	650	19299802	2,400–2,800	19299806	N/A

Chevy Big-Block V-8

19331572	ZZ427/480 Deluxe	427 cu in	480	490	19299801	3,000–3,400	19299805	3,000–3,400
19433409	454 HO	454 cu in	438	500	19299800	2,400–2,800	19299804	2,400–2,800
19433410	ZZ454/440 Deluxe	454 cu in	469	519	19299800	2,400–2,800	19299804	2,400–2,800
19433156	HT502	502 cu in	406	541	19299800	2,400–2,800	19299804	2,400–2,800
19433157	502 HO	502 cu in	461	558	19299800	2,400–2,800	19299804	2,400–2,800
19433162	ZZ502/502 Deluxe	502 cu in	508	580	19299801	3,000–3,400	19299805	3,000–3,400
19421200	SP502/605 Deluxe	502 cu in	605	580	19299801	3,000–3,400	19299805	3,000–3,400
19331583	ZZ572/620 Deluxe (w/4L85-E)	572 cu in	621	645	19299803	3,000–3,400	19299805	3,000–3,400
19331585	ZZ572/720R Deluxe (w/4L85-E)	572 cu in	727	680	N/A	N/A	19299805	3,000–3,400

SPECIAL NOTE: SuperMatic™ 6L80-E, 8L90-E and 10L90-E transmissions from Chevrolet Performance are shipped with a torque converter and transmission control module installed. 6L80-E works with LS, LSX and LT engines, 8L90-E and 10L90-E works with LT engines only. 6L80-E offers two stall speed options, 8L90-E and 10L90-E offer only one stall speed. See Pages 26–28 for transmission part numbers with desired stall speed.

Automatic Transmissions & Components

4L60 & 4L70-SERIES AUTOMATIC TRANSMISSIONS

19368611

SuperMatic™ 4L65-E Four-Speed Automatic Transmission – LS-Series V-8 (remanufactured)

- Similar in design to the 4L60-E
- Electronically controlled four-speed overdrive transmission
- Features five-pinion gearsets, heat-treated stator shaft splines, induction-hardened turbine shaft, seven-plate 3.4 clutch
- Gear ratios: 1st: 3.06, 2nd: 1.62, 3rd: 1.00, 4th: 0.70
- Use SuperMatic™ converter for direct bolt up to Gen I and Gen II engines
- Tested up to 430 lb-ft of torque
- Does not include torque converter (see pages 22–23 for options)

NOTE: Use with electronic controller P/N 19332775 for carbureted and Ram Jet applications. Use with electronic controller P/N 19302405 with Chevrolet Performance LS and LT fuel-injected applications.



SuperMatic™ 4L70-E Four-Speed Automatic Transmission (remanufactured)

- Based on the 4L60-E/4L65-E
- Increased horsepower and torque capacity over 4L60-E and 4L65-E
- Features five-pinion gearsets, heat-treated stator shaft splines, induction-hardened turbine shaft, seven-plate clutch and specific valve-body calibration
- Gear ratios: 1st: 3.06, 2nd: 1.62, 3rd: 1.00, 4th: 0.70
- Torque converter not included (see pages 22–23)
- Tested up to 495 lb-ft. of torque



Part Number	Description
19368612	Four-Wheel Drive
19368613	Two-Wheel Drive (not shown)
19368614	Two-Wheel Drive, LT1 (not shown)

NOTE: Use with electronic controller P/N 19332775 for carbureted and Ram Jet applications. Use with electronic controller P/N 19302405 with Chevrolet Performance LS and LT fuel-injected applications.

19368615

SuperMatic™ 4L75-E Four-Speed Automatic Transmission (remanufactured)

- Based on the 4L65-E/4L70-E
- Tested up to 650 lb-ft. of torque
- Features five-pinion gearsets, heat-treated stator shaft splines, induction-hardened turbine shaft, 8-friction-plate 3–4 clutch and specific valve-body calibration
- Unique, high-strength input housing
- Higher-capacity servo than 4L65E and 4L70E
- Performance 2–4 band
- Gear ratios: 1st: 3.06, 2nd: 1.62, 3rd: 1.00, 4th: 0.70
- Torque converter not included (see pages 22–23)

NOTE: Use with electronic controller P/N 19332775 for carbureted and Ram Jet applications. Use with electronic controller P/N 19302405 with Chevrolet Performance LS fuel-injected applications.



4L60- & 4L70-SERIES INSTALLATION COMPONENTS



Gen VLT1 A/T Bell Housing Kit



Transmission Installation Kit – 4L60/4L70 Series



Transmission Adapter Kit

Part Number	Description	Technical Notes
19125817	Bell Housing Kit – LT Engine	Unique bell housing kit enables 1996-later 4L60, 4L65, 4L70 and 4L75 four-speed automatic transmissions to be matched with the Gen V LT1 engine; Use with 8-bolt flexplate kit P/N 19329416
19259117	Transmission Installation Kit – 4L60/4L70 Series	Use with 4L60, 4L65, 4L70 and 4L75-E transmissions on LS engines with 6-bolt crankshaft flange; Includes flexplate, flexplate covers, fasteners and instruction sheet; Does not fit LSA, LSX454, LS9, LT1 or LT4 engines
19329416	Transmission Installation Kit – 4L60/4L70 Series (not shown)	Use with 4L60, 4L65, 4L70 and 4L75-E transmissions on LS engines with 8-bolt crankshaft flange; Includes flexplate, flexplate covers, fasteners and instruction sheet; Fits LSA, LSX454, LT1 and LT4
19433118	Transmission Installation Kit – 4L60/4L70 Series (not shown)	Use with 4L60, 4L65, 4L70 and 4L75-E transmissions on Small-Block and Big-Block crate engines with 6-bolt crankshaft flange; Designed to be used with SuperMatic™ converters; Does not include flexplate
19420473	Transmission Installation Kit – 4L60/4L70 Series	Same as 1943118 but includes flex plate and attachment bolts
19154766	Transmission Adapter Kit	Allows installation of Gen III/IV-style 4L60-E/4L65-E transmission onto Gen I and II engines using production-style torque converter; Includes spacer ring, shims, dowels, bolts and flexplate; Works on one-piece rear main seal engines only (e.g. Ram Jet 350)
24502513	4L60/700R4 Transmission Swap Kit (not shown)	Adapts the 4L60 or 700R4 automatic transmission (non-electronic version) for use in early model vehicles, with or without an engine management computer; Includes instruction sheet, throttle valve spring for carbureted engines, a normally closed fourth-gear clutch switch and wiring connector for the torque converter NOTE: For individual flywheel and flexplate components see pages 103, 157 and 202.

4L80-SERIES AUTOMATIC TRANSMISSION (remanufactured)

19300175

SuperMatic™ 4L85-E Four-Speed Transmission

- Modified valve body for firmer shifts than production 4L85-E
- Direct bolt-on for Gen I Small-Block and all Big-Blocks
- Does not include torque converter (see pages 22–23 for options)
- Includes additional clutch plates
- Gear ratios: 1st: 2.48, 2nd: 1.48, 3rd: 1.00, 4th: 0.75
- Tested up to 690 lb-ft of torque

NOTE: Use with electronic controller P/N 19332780 for carbureted and Ram Jet applications. Use with electronic controller P/N 19302410 with Chevrolet Performance LS fuel-injected applications. Torque converter not included. See automatic transmission torque converter match listing chart on page 23.

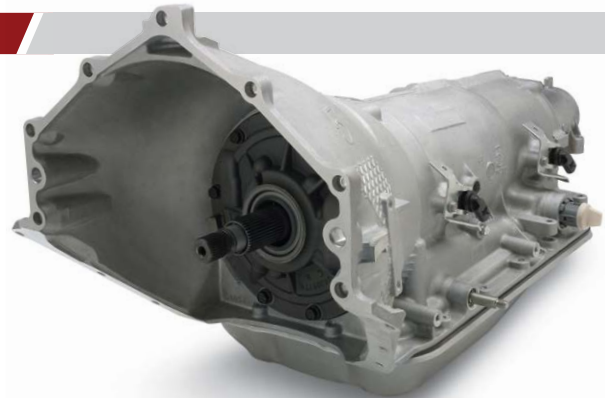

4L80-SERIES INSTALLATION COMPONENTS

19259119

Transmission Installation Kit – 4L80 Series

- Use with all LS engines to mate transmission fully with the engine
- Includes flywheel cover, hardware and fastener torque specs
- Does not include flexplate
- Use flexplate P/N 12654640 for 6-bolt crankshaft engines and SuperMatic™ converters
- Use flexplate P/N 12636325 for 8-bolt crankshaft engines and SuperMatic™ converters
- All production converters must use crankshaft adapters (see kits page 27)



19420956

Transmission Installation Kit – 4L80 Series

- Use with all Big-Block crate engines to mate transmission fully with the engine
- Includes flywheel cover, hardware and fastener torque specs
- Designed to be used with SuperMatic™ Converters
- Does not include flexplate



6L80-E SIX-SPEED AUTOMATIC TRANSMISSIONS

SuperMatic™ 6L80-E Six-Speed Transmission

Developed with upgraded internal components, Chevrolet Performance's SuperMatic™ 6L80-E six-speed automatic transmission offers an exceptional torque rating of 650 lb.-ft.—a 45-percent increase over regular-production versions of the six-speed automatic. A deep 4.02:1 first gear enables strong launch performance, while the 0.67:1 top gear supports balanced performance on the highway. It is designed for use with Chevrolet Performance's LS and LSX crate engines, as well as LT1 and LT4 crate engines. A 4WD version is available for LS/LSX engines and includes a tail designed to mate with a transfer case. Additional highlights:

- Electro/hydraulic controls with clutch-to-clutch shifting
- Torque rating: 650 lb.-ft.
- Gear ratios: 1st: 4.02, 2nd: 2.36, 3rd: 1.53, 4th: 1.15, 5th: 0.85, 6th: 0.67
- Lightweight die-cast aluminum case contributes to dry weight of approximately 195 lbs.
- Approximately 29.9 in. long (2WD version)
- Uses DEXRON VI premium fluid
- Does not include dipstick
- Includes truck-style production oil pan (use Shallow Pan Kit P/N 19418242 for increased ground clearance)
- Kit includes controller and harness, with calibrations for street and track; harness also includes paddle-shift connection
- Includes production vent tube assembly
- Kit includes transmission bulkhead connector that supports aftermarket gear indicator displays, electronically controlled shifters and more
- Chevrolet Performance-specific design includes provisions for an aftermarket transmission cooler, including -6 AN fittings
- Kit includes laptop connection cable for custom tuning transmission shift points and feel. Transmission Control Interface Cable (single license use - cannot be used with multiple transmissions)
- Use only for Performance Parts applications, not as a service replacement for GM production vehicles



Transmission Kit Part Number Includes Torque Converter

Part Number	Description	Notes
19366637	Use with LS/LSX 2WD with 2400-stall converter (included)	19366637 is preloaded with calibration for Crate L96 Engine
19417102	Use with LS/LSX 2WD with 3000-stall converter (included)	19417102 is preloaded with calibration for Crate LS/LSX Engine
19432680	Use with LS/LSX 4WD with 2400-stall converter (included)	19432680 is preloaded with calibration for Crate L96 Engine
19432790	Use with LS/LSX 4WD with 3000-stall converter (included)	19432790 is preloaded with calibration for Crate LS/LSX Engine
19432682	Use with LT1/LT4/L8T/L8P 2WD with 2400-stall converter (included)	19432682 is preloaded with calibration for Crate L8T Engine
19432684	Use with LT1/LT4/L8T/L8P 2WD with 3000-stall converter (included)	19432684 is preloaded with calibration for Crate LT1/LT4 Engine
19435284	Use with LT1/LT4/L8T/ L8P 4WD with 2400-stall converter (included)	19433584 is preloaded with calibration for Crate L8T Engine
19435286	Use with LT1/LT4/L8T/ L8P 4WD with 3000-stall converter (included)	19435286 is preloaded with calibration for Crate LT1/LT4 Engine

NOTE: All SuperMatic™ 6L80-E Transmissions are supplied with USB memory drive and data cable to allow customers to change the calibration to match their crate engine. For example, a customer may purchase 19432682 with 2400 stall converter to use with LT1, LT4, or L8P engine in which case, they'll need to install software (from USB drive) onto a PC, then connect the provided USB data cable to the data connection on the engine harness, then program the transmission calibration which matches their crate engine. Detailed procedures may be found by following this link: www.chevrolet.com/index/performance/resources/installation-guides/installation-guides/transmissions.html?extcmp=cpp_catalog_transmissions



19418242

SuperMatic™ 6L80-E Shallow Oil Pan Kit

Chevrolet Performance's Shallow Oil Pan Kit increases the ground clearance for lower-profile vehicles by replacing the standard oil pan on the SuperMatic 6L80-E Six-Speed Automatic Transmission (P/N 19366637 or 19417102) with one that is approximately 1.2 inches (30.7mm) shorter. Additional highlights:

- Production-style pan originally used on the Pontiac G8
- Includes oil fill plug (eliminates dipstick)
- Kit includes oil pan, filter and gasket



LS & LT Engine Attachment Kits for SuperMatic™ 6L80-E Transmission (not shown)

Chevrolet Performance's installation kits for the SuperMatic™ 6L80-E Six-Speed Automatic Transmission are designed to be used with LS and LT crate engines.

19420358 LS Engine Attachment Kit

- Includes flexplate for 6-bolt crankshaft, necessary covers and bolts
- Dipstick not included

19435470 LT Engine Attachment Kit

- Includes flexplate for 8-bolt crankshaft, necessary covers and bolts
- Dipstick not included
- For use with LT-Series Crate Engines (LT1, LT4, L8T, and L8P)

IMPORTANT NOTE:

Do not use pre-2022 LT1 and LT4 Engine Controllers with 2022 LT1 and LT4 crate engines. Correct applications are listed below.

Engine Controller/Transmission Compatibility for LT1 and LT4

Engine Description	Engine P/N	Fuel Pressure Sensor	Transmission Type	Engine Controller Kit P/N
LT1 Wet Sump	19431953	3 Pin	4-Speed and 6-Speed Automatic	19433246
LT1 Wet Sump	19431953	3 Pin	6-Speed Automatic	19433601
LT1 Wet Sump	19431953	3 Pin	8-Speed and 10-Speed Automatic	19433247
LT4 Wet Sump [Camaro ZL-1]	19431955	3 Pin	4-Speed and 6-Speed Automatic	19433248
LT4 Wet Sump [Camaro ZL-1]	19431955	3 Pin	6-Speed Automatic	19433632
LT4 Wet Sump [Camaro ZL-1]	19431955	3 Pin	8-Speed and 10-Speed Automatic	19433249

8L90-E EIGHT-SPEED AUTOMATIC TRANSMISSIONS

SuperMatic™ 8L90-E Eight-Speed Transmission

Chevrolet Performance has adapted the production-based 8L90-E eight-speed automatic transmission for use with the LT1 and LT4 crate engines. A numerically high 4.56 first gear ratio offers strong take-off performance while a wide 7.0:1 overall ratio helps enhance cruising efficiency. Additional highlights:

- Compatible with 3-pin LT design engines only
- Four gearsets for efficiency
- Five clutches: two brake clutches and three rotating clutches
- Friction-reducing features include synthetic fluid
- Gear ratios: 1st: 4.56, 2nd: 2.97, 3rd: 2.08, 4th: 1.69, 5th: 1.27, 6th: 1.00, 7th: 0.85, 8th: 0.65, reverse: 3.82
- Controller and harness included
- Torque converter included (engine specific)



- Torque rating: 715 lb.-ft.
- Includes cooler line adapter to -6AN fitting
- Includes production-style vent tube

Part Number	Description	Technical Notes
19419798	SuperMatic™ 8L90-E Transmission for LT1 Crate Engine	Use with LT1 crate engines P/N 19431953 (3-pin design) and P/N 19433059 LT1 E-ROD; Includes torque converter, controller and harness; Must be used with compatible engine controller (see page 114 for engine controller applications)
19419799	SuperMatic™ 8L90-E Transmission for LT4 Crate Engine	Use with LT4 crate engine P/N 19431955 (wet sump) and P/N 19433067 LT4 E-ROD; Includes torque converter, controller and harness; Must be used with compatible engine controller (see page 114 for engine controller applications)

8L90-E INSTALLATION COMPONENTS

19417103

LT Engine Attachment Kit for SuperMatic™ 8L90-E Transmission (not shown)

Chevrolet Performance's installation kit for the SuperMatic™ 8L90-E eight-speed automatic transmission is designed to be used with LT1 and LT4 crate engines. It includes the necessary covers, bolts, cooler line and more.

- LT1 and LT4 crate engines include a flexplate compatible with the SuperMatic™ 8L90-E
- A dipstick is not included. An aftermarket dipstick must be used

NOTE: The pre-programmed transmission controller and wiring harness are specific to each SuperMatic™ 8L90-E transmission part number and are included with the transmission kit.

19418408

8-Bolt Flexplate Kit for LT Engines

- Kit includes flexplate and fasteners
- Compatible with LT1 and LT4 engines, but not required, as each includes a factory-installed flexplate



CRANKSHAFT ADAPTERS

19125597

8-Bolt Crankshaft Adapter Kit – LSX

- Use with LSX454 & LSX376-B15 with 8-bolt crankshaft flange
- Includes flexplate, adapter hub and hardware
- Provides the correct converter pilot support for production 4L80/85 style torque converters
- Conventional 6-bolt flexplates do not bolt up to LSX454 engines



6-Bolt Crankshaft Adapter Kit – LS Engine

- For use with Gen I style (Turbo 350/400, 700R4, 4L60, 4L60-E and 4L85-E) transmission on Gen III and Gen IV engines
- Flexplate 19260102 has only 11.5" (4L80-style) torque converter bolt pattern. Other applications may need to modify flexplate to use



For 6-Bolt Crankshaft Adapter, order the following parts:

Part Number	QTY	Part
12563532	1	Crankshaft Spacer
19260102	1	Flexplate
19257940	6	Mounting Bolts

NOTE: Only 11.5" bolt circle. For individual flywheel and flexplate components see pages 103, 157 and 202.

10L90-E TEN-SPEED AUTOMATIC TRANSMISSIONS

- 19436466** for LT1 Crate Engine
- 19436467** for LT4 Crate Engine
- 19435613** for L8T Crate Engine

SuperMatic™ 10L90-E Ten-Speed Automatic Transmission

Chevrolet Performance's SuperMatic™ 10L90-E ten-speed transmission offers a technologically advanced balance of performance and efficiency when matched with LT1 and LT4 crate engines. The kit features a slip yoke-type tail shaft, allowing it to be used with the conventional prop shaft design used in most older vehicles.

Additional highlights:

- Electro/hydraulic controls with clutch-to-clutch shifting
- Four gearsets and six clutches: two brake clutches and four rotating clutches
- 7.39:1 overall gear ratio spread
- Aggressive 4.70:1 first gear for enhanced off-the-line performance
- Three overdrive gears, with 0.64:1 top gear ratio



- Torque rating: 650 lb.-ft.
- Includes torque converter and controller
- Includes cooler line adapter with #6 AN fittings
- Includes production-style vent tube
- Must be used with compatible engine controller (see page 114 for engine controller applications)

10L90-E INSTALLATION COMPONENTS

19420810

10L90-E Installation Kit for LT Engines (not shown)

Includes covers, cover attachment bolts, transmission attachment bolts, torque converter bolts and unique yoke.

12685003

10L90-E Flexplate for 2023 and older L8T Crate engines (not shown)

This flexplate is necessary only for older L8T Crate engines which were originally equipped to support the 6L80-E transmission (L8T Engine P/N 19433748)

TRANSMISSION CONTROL SYSTEMS

SuperMatic™ Transmission Control Systems for LS and LT

- Pre-programmed — provides full function transmission operation after completing connections
- No laptop programming required
- Only compatible with E-67 and E-92 based Chevrolet Performance electronic LS and LT engine control systems
- Optional features for personal preferences
 - Gearshift timing
 - Multiple shift patterns
 - Manual shift mode
 - Supports most wheel-mounted paddles
 - On-board data logging
- Connect & Cruise: simple connections with no additional wiring required. Connect the clearly marked leads to the engine control harness, and you're ready to cruise!



19302405 (shown)

- 1996–2008 4L60-E family transmissions
- Compatible with P/N 19368611, 19368613, 19368612, 19368615 and 19368614 Chevrolet Performance SuperMatic™
- Revised, more compact design for easier installation in smaller areas
- Enhanced shift pressure performance for improved shift control
- Compatible with OBD-II code readers

19302410

- 1993–up 4L80-E family transmissions
- Compatible with P/N 19300175 Chevrolet Performance SuperMatic™
- Revised, more compact design for easier installation in smaller areas
- Enhanced shift pressure performance for improved shift control
- Compatible with OBD-II code readers

SuperMatic™ Transmission Control Systems for Carbureted Small-Block, Big-Block and Ram Jet Engines

- Pre-programmed — provides full function transmission operation after completing connections
- No laptop programming required
- Only compatible with carbureted or Ram Jet engine applications
- Optional features for personal preferences
 - Gearshift timing
 - Multiple shift patterns
 - Manual shift mode
 - Supports most wheel-mounted paddles
 - On-board data logging
- Plug and play: Simple connections with no additional wiring required.



19332775 (shown)

- 1996–2008 4L60-E family transmissions
- Compatible with P/N 19368611, 19368613, 19368612, 19368615 and 19368614 Chevrolet Performance SuperMatic™
- Revised, more compact design for easier installation in smaller areas
- Enhanced shift pressure performance for improved shift control
- Compatible with OBD-II code readers
- For carbureted Small-Block, Big-Block and Ram Jet engines

19332780

- 1993–up 4L80-E family transmissions
- Compatible with P/N 19300175 Chevrolet Performance SuperMatic™
- Revised, more compact design for easier installation in smaller areas
- Enhanced shift pressure performance for improved shift control
- Compatible with OBD-II code readers
- For carbureted Small-Block, Big-Block and Ram Jet engines

Manual Transmissions & Components

SIX-SPEED SUPER MAGNUM TRANSMISSION

19352208

Super Magnum Six-Speed Manual Transmission

This high-torque capacity TREMEC six-speed manual is designed for custom, retro-fit installations with Chevrolet Performance crate engines. The exterior case is similar to fourth-generation F-body transmission with the stronger, high-capacity gear sets, input shaft and output shaft used in the TREMEC TR6060.

- 700 lb.-ft. maximum torque capacity
- 26-spline input shaft
- 31-spline output shaft
- Gear ratios: 2.66 (1), 1.78 (2), 1.30 (3), 1.00 (4), 0.80 (5), 0.63 (6)
- Slip-yoke design
- 40-tooth reluctor ring that's necessary for use with electronic vehicle speed sensors used with Chevrolet Performance controllers
- Two-position shifter plate included, with third position built into the transmission



- Kit includes shifter handle and Chevrolet Performance-logo ball-type shift knob (see page 31)
- Approximately 33.6 inches long with bell housing attached (bell housing included in separate installation kits)

MANUAL TRANSMISSION INSTALLATION COMPONENTS

19329025

Bell Housing Kit – Small-Block and Big-Block Engines

- Allows six-speed Super Magnum transmission P/N 19352208 to bolt up to a Gen I Small-Block and all Big-Block engines
- SFI steel bell housing
- Includes Block-Saver Plate and attaching hardware
- 5.950" deep
- Clutch kit not included. Use clutch kit P/N 19329633 for Small-Block and P/N 19329634 for Big-Block
- Designed for hydraulic concentric slave cylinder release bearing P/N 24264182 (see page 31)



19301625

Transmission Installation Kit – Six-Speed Super Magnum for LS Engines with 6-bolt flange

- Use with six-speed Super Magnum transmission P/N 19352208 and LS engines except LSA, LSX376-B15 and LSX454
- LS7-style flywheel with 6-bolt flange
- LS7-style high-strength clutch and pressure plate
- Fourth-generation F-body-type bell housing and clutch release bearing included
- Kit includes dust covers, hardware and instructions



19329620

Bell Housing Kit – LS and LT Engines

- Allows six-speed Super Magnum transmission P/N 19352208 to bolt up to any Gen III/Gen IV LS engine or Gen V LT engine
- SFI steel bell housing
- Includes Block-Saver Plate and attaching hardware
- 5.555" deep
- Clutch kit not included. Use clutch kit P/N 19329635 for engines with 8-bolt flange, including LT engines; P/N 19331082 for engines with 9-bolt flange; and P/N 19331079 for engines with 6-bolt flange
- Designed for hydraulic concentric slave cylinder release bearing P/N 24264182 (see page 31)



19329633

Clutch Kit – Small-Block Engines

- High-performance single-disc clutch that fits production Small-Block flywheels
- Rated for 450 lb.-ft. of torque
- Fits 168-tooth flywheel P/N 14088648
- Kit includes pressure plate and additional hardware



Manual Transmission Installation Components continued

19329634
Clutch Kit – Big-Block Engines

- High-performance single-disc clutch that fits production Big-Block flywheels
- Rated for 650 lb.-ft. of torque
- Fits 168-tooth flywheel:
 - P/N 14096987 - 454 & 502 crate engines (externally balanced)
 - P/N 12582964 - 427 & 572 crate engines (internally balanced)
- Kit includes pressure plate and additional hardware

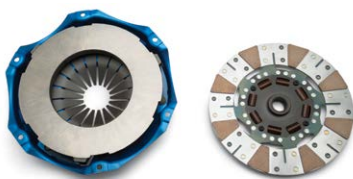

19329635
Clutch Kit – LS/LT Engines, 8-Bolt Crank

- High-performance dual-disc clutch and flywheel package for LS and LT engines with 8-bolt flywheel flange
- Will not fit LS engines with 6-bolt flange
- Rated for 800 lb.-ft. of torque
- Kit includes flywheel, pressure plate, clutch disc and additional hardware



19331082
Clutch Kit – LS9 Engine, 9-Bolt Crank (not shown)

- High-performance dual-disc clutch and flywheel package for LS9 engines with 9-bolt flywheel flange
- Rated for 800 lb.-ft. of torque
- Kit includes flywheel, pressure plate, clutch disc and additional hardware

19331079
Clutch Kit – LS3/LS7 Engines, 6-Bolt Crank (not shown)

- High-performance dual-disc clutch and flywheel package for all LS engines with 6-bolt flywheel flange
- Rated for 800 lb.-ft. of torque
- Kit includes flywheel, pressure plate, clutch disc and additional hardware

19329900
Transmission Installation Kit – Six-Speed Super Magnum for Small-Block

- Use with six-speed Super Magnum transmission P/N 19352208 Small-Block engines with one-piece rear main seal
- Super Magnum bell housing
- 1986-later flywheel
- High-strength clutch and pressure plate
- Kit includes dust covers, pilot bearing, hardware and instructions



19329901
Transmission Installation Kit – Six-Speed Super Magnum for 454 and 502 Big-Block

- Use with six-speed Super Magnum transmission P/N 19352208 and 454 and 502 crate engines (externally balanced)
- Not for use with 427/572 engines that are internally balanced
- Super Magnum bell housing
- Externally balanced flywheel
- High-strength clutch and pressure plate
- Kit includes dust covers, pilot bearing, hardware and instructions



19329902
Transmission Installation Kit – Six-Speed Super Magnum for 427 and 572 Big-Block (not shown)

- Use with six-speed Super Magnum transmission P/N 19352208 and 427 and 572 crate engines (internally balanced)
- Use also with 350/290 HP crate engines with two-piece main seal
- Not for use with 454 and 502 engines that are externally balanced
- Super Magnum bell housing
- Internally balanced flywheel
- High-strength clutch and pressure plate
- Kit includes dust covers, pilot bearing, hardware and instructions

19329912
Transmission Installation Kit – Six-Speed Super Magnum for LS/LT engines with 8-bolt flange

- Use with six-speed Super Magnum transmission P/N 19352208 and LSA, LSX376-B15, LSX454 and LSX454R engines
- Use with six-speed Super Magnum transmission P/N 19352208 and LT1 crate engine P/N 19329997 (dry sump), and LT4 crate engines P/Ns 19431955 (wet sump) and 19332702 (dry sump)
- Super Magnum bell housing
- High-strength clutch and pressure plate
- Kit includes dust covers, pilot bearing, hardware and instructions



19331080
Transmission Installation Kit – Six-Speed Super Magnum for LS engines with 6-bolt flange (not shown)

- Use with six-speed Super Magnum transmission P/N 19352208 and all LS engines
- Super Magnum bell housing
- High-strength clutch and pressure plate
- Kit includes hydraulic slave cylinder, pilot bearing, hardware and instructions

19331083
Transmission Installation Kit – Six-Speed Super Magnum for LS9 engines with 9-bolt flange (not shown)

- Use with six-speed Super Magnum transmission P/N 19352208 and LS9 engines
- Super Magnum bell housing
- High-strength clutch and pressure plate
- Kit includes hydraulic slave cylinder, pilot bearing, hardware and instructions

19301622

Chevrolet Performance Shifter Handle Kit

- Includes a black shifter handle and installation hardware



24264182

Hydraulic Concentric Slave Cylinder Release Bearing

- Gen 4 F-Car (LS1) release bearing
- Used for Chevrolet Performance bell housings and clutch packages



19301623

Chevrolet Performance-Logo Shifter Ball Kit

- Give your Tremec® Super Magnum six-speed-equipped project a distinctive, heritage-inspired look with a classic ball-style shift knob emblazoned with the Chevrolet Performance logo
- Includes the Chevrolet Performance logo ball-style shift knob and installation hardware



TR6060 SIX-SPEED MANUAL TRANSMISSION

92246731

TR6060 Six-Speed Manual Transmission

- A direct replacement transmission for your Camaro SS
- Rated to handle 420 lb.-ft. of torque
- Works with any Chevrolet Performance LS crate engines except LSA and LSX454
- Equipped with 26-spline input shaft and a fixed-yoke production-style output shaft
- Includes release bearing
- Use with installation kit P/N 19259271
- Requires body-mounted shifter (not included)

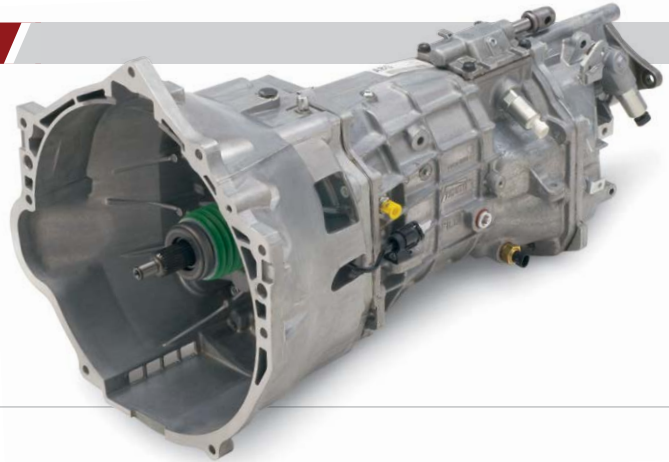

24264047

TR6060 Six-Speed Manual Transmission (not shown)

- High-torque-capacity transmission used in the Cadillac CTS-V Series with the 556-hp/551-lb.-ft. LSA supercharged 6.2L engine
- Direct fit with LSA and LSX454 crate engines with 8-bolt crankshaft flange
- Includes release bearing

- Equipped with 26-spline input shaft and a fixed-yoke production-style output shaft
- Use with installation kit P/N 19259270
- Requires body-mounted shifter (not included)

TR6060 INSTALLATION COMPONENTS



Transmission Installation Kit – TREMEC TR6060 (MG9), 8-Bolt Flange



Transmission Installation Kit – TREMEC TR6060 (MG10), 6-Bolt Flange



LSX/LS7 Clutch Kit

Part Number	Description	Technical Notes
19259270	Transmission Installation Kit – TREMEC TR6060 (MG9), 8-Bolt Flange	Use with TR6060 six-speed transmission P/N 24264047 only with LSA, LSX454 and LSX454R engines; Includes flywheel with 8-bolt flange, high-strength clutch and pressure plate, dust covers, hardware and instruction sheet; Clutch release bearing is included with the transmission assembly
19259271	Transmission Installation Kit – TREMEC TR6060 (MG10), 6-Bolt Flange	Use with TR6060 six-speed transmission P/N 92246731 on all LS engines except LSA, LS9, LSX454 and LSX454R; Includes flywheel with 6-bolt flange, high-strength clutch and pressure plate, dust covers, hardware and instruction sheet; Clutch release bearing is included with the transmission assembly
24255748	LSX/LS7 Clutch Kit	11.5" clutch single disc; Fits 26-spline shaft; Pressure plate and clutch disc
24260226	LS9 Clutch Kit (not shown)	10.5" clutch dual disc; Fits 26-spline shaft; Dual-mass clutch and pressure plate for LS9 Corvette ZR1
12570806	LS2 Clutch Kit (not shown)	11.5" clutch single disc; Fits 26-spline shaft; Flywheel, clutch and pressure plate kit for LS2 GT0 engines
12581650	LS1 Clutch Kit (not shown)	11.5" clutch single disc; Fits 26-spline shaft; Flywheel with pressure plate and disc for LS1 Camaro engines
19433172	Release Bearing (actuator) (not shown)	Included with Transmission Kit P/N 92246731



Performance

CONNECT & CRUISE

CRATE POWERTRAIN SYSTEMS

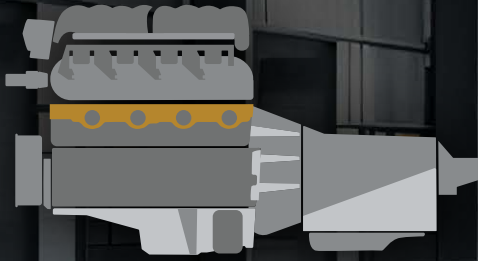

*LT4 6.2L Connect & Cruise System
with 8-Speed Automatic*

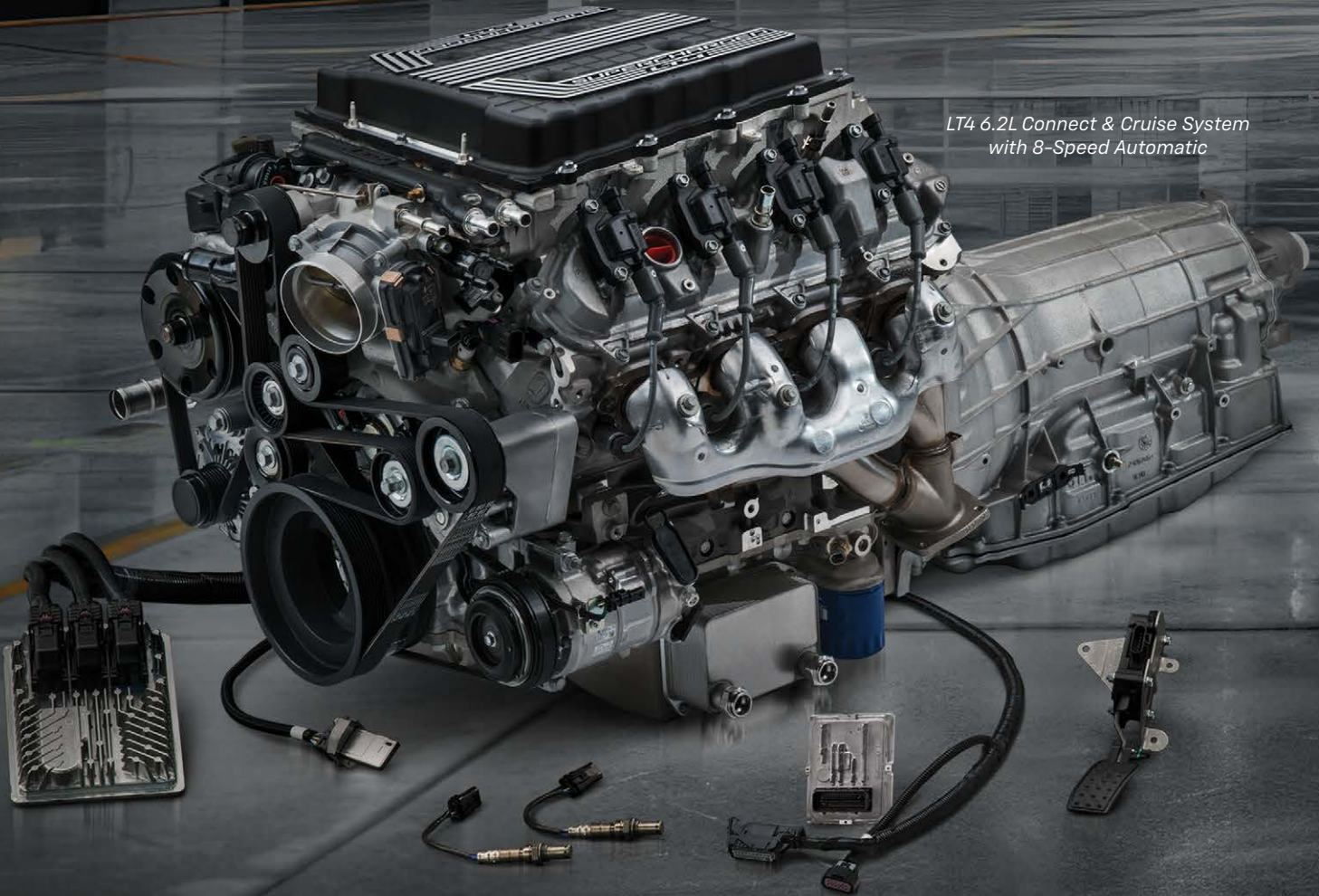

Factory-Matched Performance Engine-and-Transmission Combos!

Chevrolet Performance's innovative Connect & Cruise factory-matched engine-and-transmission combinations reduce the time and hassle of picking the parts to power your project vehicle.

Each system matches one of our performance Small-Block, Big-Block, LS and LT crate engines with a complementary transmission, as well as the supporting calibrated controllers, torque converters (for automatic transmissions) and installation kits. Simply review the charts on the accompanying pages to find the engine-and-transmission combo that's right for your project, along with all the required part numbers.

The combos include E-ROD Connect & Cruise systems, with CARB-approved engine kits, and all Connect & Cruise systems are backed by a 24-month/50,000-mile limited warranty. (See ChevroletPerformance.com or your Chevrolet Performance retailer for complete details.)

Build your project with confidence! With Chevrolet Performance's Connect & Cruise combinations, it's never been easier to pick your powertrain.



Connect & Cruise Builder's Guide

Each Chevrolet Performance Connect & Cruise Crate Powertrain System includes:

- **Instruction sheet**
- **Brand-new crate engine**
- **Automatic or manual transmission**
- **Transmission Installation Kits**
- **SuperMatic™ transmission control module and harness (automatic transmission only)**
- **Calibrated engine control module**
- **Two oxygen sensors and mounting bosses (for installation in the exhaust system)**
- **Mass airflow meter and mounting boss (for installation in the air intake system)**
- **Throttle pedal assembly (for use with the electronically operated throttle)**
- **Assembled wiring harness with fuse box and necessary cam sensor and MAP sensor jumpers**

NOTE: E-ROD C&C package includes rear oxygen sensors, catalytic converters, air inlet filter and purge canister.

NOTE: LT kits include fuel line pressure sensor.

NOTE: All components, engines, transmissions, transmission installation kits, torque converters and controllers are ordered and delivered separately.

To facilitate a complete installation, the builder will need to source additional components to complete the engine assembly and get the vehicle running, including:

- Fuel tank and fuel lines (re-circulating or returnless)
- Fuel pump: 45 G/H (gallons per hour) at 58 psi (400 kPa) for all non-boosted engines (LS and LT)
65 G/H (gallons per hour) at 72 psi (500 kPa) for LT4 and all boosted engines (LS and LT)
- Air induction system that incorporates the mass airflow sensor
- Starter and exhaust systems

Additionally, all engines require a Front-End Accessory Drive system. The instruction manual included with each kit offers recommendations, and Chevrolet Performance offers several configurations to suit different applications. Each allows the installer to easily delete air conditioning. See page 104 for applications and part numbers.

Chevrolet Performance recommends the LS1 Engine Installation Guide P/N 88959384, which illustrates basic procedures and offers helpful tips on installing an LS engine in older vehicles.

About Chevrolet Performance Engine and Transmission Controllers

The Connect & Cruise engine controller and SuperMatic™ transmission controller are designed for true stand-alone performance in older vehicles. All that's needed to get a vehicle running with the engine controller are power and ground sources, a high-pressure fuel pump and electric cooling fans. For all non-boosted engines (LS and LT), Chevrolet Performance recommends a 45 G/H (gallons per hour) at 58 psi (400 kPa) fuel pump. The LT4 and all boosted engines (LS and LT) require a 65 G/H (gallons per hour) at 72 psi (500 kPa) pump.

Chevrolet Performance's specially calibrated engine controller does not utilize a number of features associated with production-model systems, eliminating the possibility of "trouble codes" being set. It also includes a SES (service engine soon) LED indicator embedded in the fuse box.

The SuperMatic™ transmission controller is the most fully integrated and user-friendly transmission control system on the market. Only a few connections are required to get the transmission ready for operation in your vehicle—and it is designed for tuning-free compatibility with the Connect & Cruise systems' engine control modules.

NOTE: Installing an electronically controlled automatic transmission in an older vehicle with a mechanical speedometer requires an aftermarket signal converter.

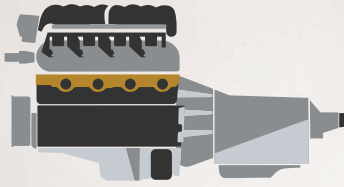

CONNECT & CRUISE

CRATE POWERTRAIN SYSTEMS

Simplify your installation with pre-matched combinations from Chevrolet Performance!

Chevrolet Performance's Connect and Cruise systems make it simple to optimize performance and minimize hassle. Our engineers have paired the right engines, transmissions and controllers with the right Big-Block, Small-block, LS or LT crate engine to take the guesswork out of your build. It is the easy, economical way to get you going quickly!

Select your Crate Powertrain System from the charts on the following pages.

NOTE: All components, engines, transmissions, transmission installation kits, torque converters and controllers are ordered and delivered separately. This part is intended for competition use only. See page 2 for details.



Fuel Injected Engines with Automatic Transmissions

See page 35



Carbureted Engines with Automatic Transmissions

See page 36

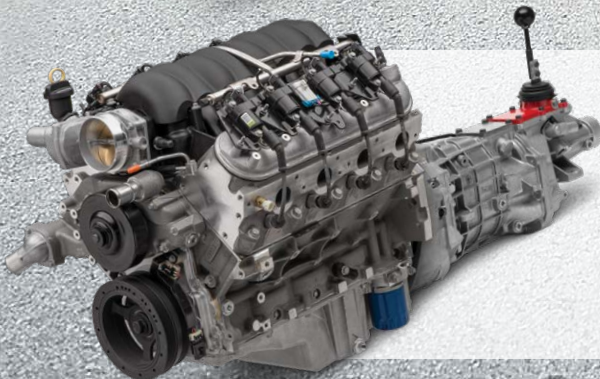

Carbureted & Fuel Injected Engines with Manual Transmissions





























See page 37







Chevrolet Performance Connect & Cruise Crate Powertrain Systems include a 24-month or 50,000-mile (whichever comes first) limited warranty. E-ROD Connect & Cruise Crate Powertrain Systems include a 36-month or 50,000 mile (whichever comes first) limited warranty. See dealer for details.

Fuel Injected Engines with Automatic Transmissions

LS/LT-SERIES

Connect & Cruise System	Engine	Engine Controller	Transmission Installation Kit	Transmission	Torque Converter	Transmission Controller
LS3 6.2L w/4L65-E	19540155 	19354328	19259117	19368611	19299802 or 19299803	19302405
LS3 6.2L 2WD w/4L70-E	19540155 	19354328	19259117	19368613	19299802 or 19299803	19302405
LS3 6.2L 4WD w/4L70-E	19540155 	19354328	19259117	19368612	19299802 or 19299803	19302405
LS3 6.2L 2WD w/6L80-E	19540155 	19354328	19420358	19417102 or 19366637	included with trans.	included with trans.
LS3 6.2L 4WD w/6L80-E	19540155 	19354328	19420358	19432680 or 19432790	included with trans.	included with trans.
LS376/480 6.2L 2WD w/4L70-E	19540156 	19354330	19259117	19368613	19299803	19302405
LS376/480 6.2L 2WD w/6L80-E	19540156 	19354330	19420358	19417102 or 19366637	included with trans.	included with trans.
LS376/525 6.2L 2WD w/4L70-E	19540157 	19354332	19259117	19368613	19299803	19302405
LS376/525 6.2L w/4L75-E	19540157 	19354332	19259117	19368615	19299803	19302405
LS376/525 6.2L 2WD w/6L80-E	19540157 	19354332	19420358	19417102 or 19366637	included with trans.	included with trans.
LT1 6.2L Wet Sump 2WD w/4L70-E	19431953 	19433246	19329416	19368614	19299802	19302405
LT1 6.2L E-ROD Wet Sump 2WD w/4L70-E	19433063 	included with E-ROD kit	19329416	19368614	19299802	19302405
LT1 6.2L Wet Sump 2WD w/6L80-E	19431953 	19433601	19435470	19432682 or 19432684	included with trans.	included with trans.
LT1 6.2 L E-ROD Wet Sump 2WD w/6L80-E	19433869 	included with E-ROD kit	19435470	19432682 or 19432684	included with trans.	included with trans.
LT1 6.2L Wet Sump w/8L90-E	19431953 	19433247	19417103	19419798	included with trans.	included with trans.
LT1 6.2 L E-ROD 6.2 Wet Sump w/8L90-E	19433059 	included with E-ROD kit	19417103	19419798	included with trans.	included with trans.
LT1 6.2L Wet Sump w/10L90-E	19431953 	19433247	19420810	19436466	included with trans.	included with trans.
LT1 6.2 L E-ROD 6.2 Wet Sump w/10L90-E	19433059 	included with E-ROD kit	19420810	19436466	included with trans.	included with trans.
LT4 6.2L SC Wet Sump w/4L75-E	19431955 	19433248	19329416 +19125817 ¹	19368615	19299802	19302405
LT4 6.2L SC E-ROD Wet Sump w/4L75-E	19433071 	included with E-ROD kit	19329416 +19125817 ¹	19368615	19299802	19302405
LT4 6.2L SC Wet Sump 2WD w/6L80-E	19431955 	19433632	19435470	19432682 or 19432684	included with trans.	included with trans.
LT4 6.2L SC E-ROD Wet Sump 2WD w/6L80-E	19433872 	included with E-ROD kit	19435470	19432682 or 19432684	included with trans.	included with trans.
LT4 6.2L SC Wet Sump w/8L90-E	19431955 	19433249	19417103	19419799	included with trans.	included with trans.
LT4 6.2L SC E-ROD Wet Sump w/8L90-E	19433067 	included with E-ROD kit	19417103	19419799	included with trans.	included with trans.
LT4 6.2L SC Wet Sump w/10L90-E	19431955 	19433249	19420810	19436467	included with trans.	included with trans.
LT4 6.2L SC E-ROD Wet Sump w/10L90-E	19433067 	included with E-ROD kit	19420810	19436467	included with trans.	included with trans.
L8T 6.6L 2WD w/6L80-E	19435733  (2024+)	19435726	19435470	19432682 or 19432684	included with trans.	included with trans.
L8T 6.6L 2WD w/10L90-E	19435733  (2024+)	19435606	19420810	19435613	included with trans.	included with trans.
L8P 6.6L 2WD w/6L80-E	19435523 	19435524	19435470	19432682 or 19432684	included with trans.	included with trans.

SMALL-BLOCK

Connect & Cruise System	Engine	Engine Controller	Transmission Installation Kit	Transmission	Torque Converter	Transmission Controller
ZZ6 EFI Deluxe w/4L65-E	19433043  + 19419371 ²	included with engine	19420473	19368611	19299801	19332775
ZZ6 EFI Turn-Key w/4L65-E	19433044  + 19419371 ²	included with engine	19420473	19368611	19299801	19332775
SP383 EFI Deluxe w/4L70-E	19433045  + 19419371 ²	included with engine	19420473	19368613	19299800	19332775
SP383 EFI Turn-Key w/4L70-E	19433046  + 19419371 ²	included with engine	19420473	19368613	19299800	19332775

¹Bell Housing Kit

²Throttle Position Sensor



This part is 50 state emissions street legal when installed and used as described in the CARB executive order. See page 2 for details



Parts intended for competition use only. See page 2 for details.



Performance





35

Carbureted Engines with Automatic Transmissions





LS-SERIES

Connect & Cruise System	Engine	Transmission Installation Kit	Transmission	Torque Converter	Transmission Controller
LS 376/515 w/4L70-E	19435102 	19259117	19368613	19299803	19332775

SMALL-BLOCK

Connect & Cruise System	Engine	Transmission Installation Kit	Transmission	Torque Converter	Transmission Controller
350 HO Turn-Key w/4L65-E	19433031 	19420473	19368611	19299800	19332775
SP350/357 Turn-Key w/4L65-E	19433034 	19420473	19368611	19299801	19332775
SP350/385 Turn-Key w/4L65-E	19433040 	19420473	19368611	19299801	19332775
ZZ6 Turn-Key w/4L65-E	19433042 	19420473	19368611	19299801	19332775
SP383 Turn-Key w/4L70-E	19435452 	19420473	19368613	19299801	19332775

BIG-BLOCK

Connect & Cruise System	Engine	Transmission Installation Kit	Transmission	Torque Converter	Transmission Controller
ZZ427/480 Deluxe w/4L70-E	19331572 	19433118	19368613	19299801	19332775
ZZ502/502 Deluxe w/4L85-E	19433162 	19420956	19300175	19299805	19332780
SP502/605 Deluxe w/4L85-E	19421200 	19420956	19300175	19299805	19332780
ZZ572/620 Deluxe w/4L85-E	19331583 	19420956	19300175	19299805	19332780

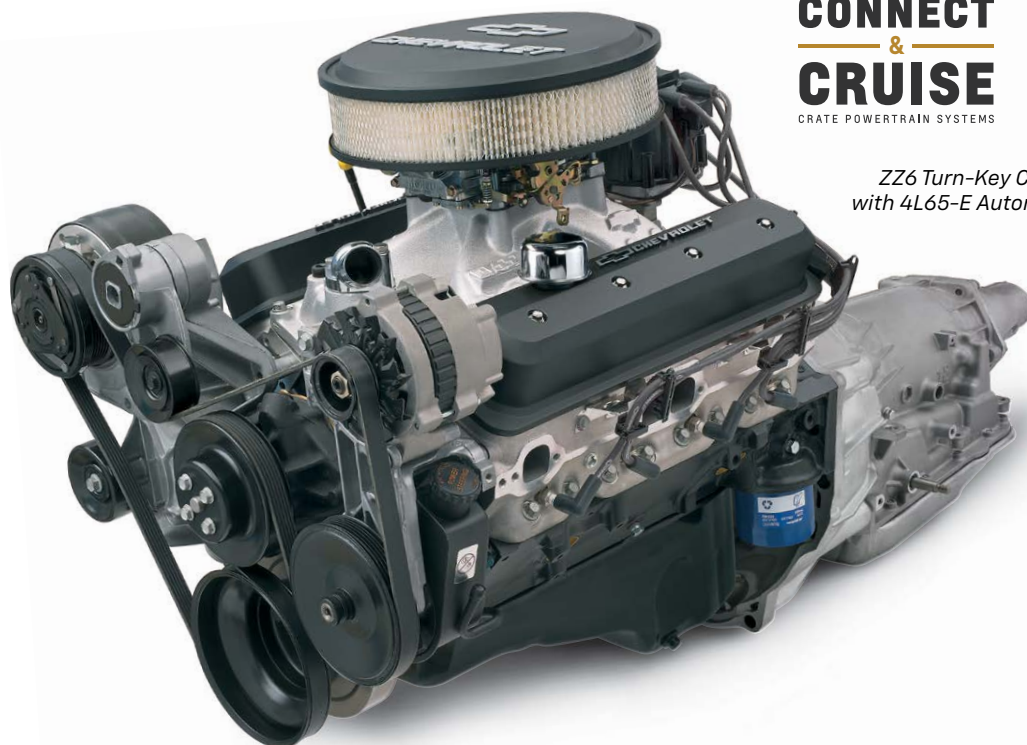



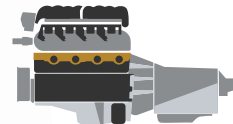





**CONNECT
&
CRUISE**
CRATE POWERTRAIN SYSTEMS











*ZZ6 Turn-Key Connect & Cruise
with 4L65-E Automatic Transmission*

Carbureted & Fuel Injected Engines with Manual Transmissions





LS-SERIES

Connect & Cruise System	Engine	Engine Controller	Transmission Installation Kit	Transmission
LS3 6.2L w/6-Speed	19540155 	19354328	19301625	19352208
LS376/480 w/6-Speed	19540156 	19354330	19301625	19352208
LS376/515 w/6-Speed	19435102 	N/A	19301625	19352208
LS376/525 w/6-Speed	19540157 	19354332	19301625	19352208
LT1 6.2L Wet Sump w/6-Speed	19431953 	19433246	19329912	19352208
LT1 6.2L E-ROD Wet Sump w/6-Speed	19433063 	included with E-ROD kit	19329912	19352208
LT4 6.2L SC Wet Sump w/6-Speed	19431955 	19433248	19329912	19352208
LT4 6.2L SC E-ROD Wet Sump w/6-Speed	19433071 	included with E-ROD kit	19329912	19352208

SMALL-BLOCK

Connect & Cruise System	Engine	Engine Controller	Transmission Installation Kit	Transmission
SP350/357 Turn-Key w/6-Speed	19433034 	—	19329900	19352208
SP350/385 Turn-Key w/6-Speed	19433040 	—	19329900	19352208
ZZ6 Turn-Key w/6-Speed	19433042 	—	19329900	19352208
ZZ6 EFI Turn-Key w/6-Speed	19433044 	—	19329900	19352208
ZZ6 EFI Deluxe w/6-Speed	19433043 	—	19329900	19352208
SP383 Turn-Key w/6-Speed	19435452 	—	19329900	19352208
SP383 EFI Turn-Key w/6-Speed	19433046 	—	19329900	19352208
SP383 EFI Deluxe w/6-Speed	19433045 	—	19329900	19352208

BIG-BLOCK

Connect & Cruise System	Engine	Engine Controller	Transmission Installation Kit	Transmission
ZZ427/480 Deluxe w/6-Speed	19331572 	—	19329902	19352208
ZZ502/502 Deluxe w/6-Speed	19433162 	—	19329901	19352208
SP502/605 Deluxe w/6-Speed	19421200 	—	19329901	19352208
ZZ572/620 Deluxe w/6-Speed	19331583 	—	19329902	19352208



This part is 50 state emissions street legal when installed and used as described in the CARB executive order. See page 2 for details



Parts intended for competition use only. See page 2 for details.



Performance

37

eCrate Electric Conversion Kits

19433445  **Short wheelbase kit**
(200" RESS cable)

19433446  **Long wheelbase kit**
(240" RESS cable)

200 hp

@ 5,400 rpm

266 lb.-ft.

@ 3,800 rpm

**Must also purchase [RESS] Battery separately*



All-new kit is the first-ever battery/motor system for EV conversions available for sale from Chevrolet Performance

Chevrolet Performance, which helped pioneer the high-performance crate engine and introduced the innovative Connect & Cruise crate engine kits, takes the next step into the future with the all-new eCrate system – the first-ever battery/motor system designed for electric-vehicle conversions available for sale from Chevrolet Performance.

The new eCrate system offers builders a comprehensive kit that includes the primary elements for converting most conventional combustion-engine-powered vehicles into fully electric propulsion. Its production-based components include a 66 kWh lithium-ion battery pack and a 400-volt electric drive motor that's designed to bolt up to most 4L60 family GM transmissions.

Additional supporting components include a thermal management system, the charging receptacle, control modules and more.

System highlights include:

- A 66 kWh production-based lithium-ion battery pack, including thermal and battery management systems
- A 400-volt electric drive motor capable of 266 lb.-ft. of torque (360 Nm) and 200 horsepower (150 kW)
- Charging receptacle and charge cord set
- Accelerator pedal
- Thermal management system with air conditioning compressor, cabin heater and more
- High-Voltage Power Electronics and supporting high-voltage cables
- Low-voltage harnesses and controllers
- Additional supporting components and hardware

IMPORTANT! Chevrolet Performance's eCrate system is only available through approved installation centers.

Visit www.chevrolet.com/performance-parts/ecrate for availability and a list of certified installers.

eCRATE DRIVE MOTOR

The Chevrolet Performance eCrate Drive Motor is a three-phase AC permanent-magnet motor that is capable of producing up to 266 lb.-ft. of torque (360 Nm) and 200 horsepower (150 kW). The motor is designed to connect directly to a GM 4-speed automatic transmission with an external mode switch. That simplifies the installation process, allowing installers to retain a more conventional drivetrain layout, with the drive motor replacing the combustion engine under the hood. The electric motor offers almost instantaneous torque making the drive a lot more fun than many traditional ICE powered vehicles.

SPECIFICATIONS:

Name:	400 Volt Automotive Drive Motor
Motor:	Synchronous permanent magnet AC
Power:	200 hp / 150 kW
Torque:	266 lb.-ft. / 360 Nm
Battery Options:	66 kWh / 400V
Additional Features:	Can be mounted to a standard GM crate transmission (4L65-E or 4L70-E)
Cooling	Liquid cooled

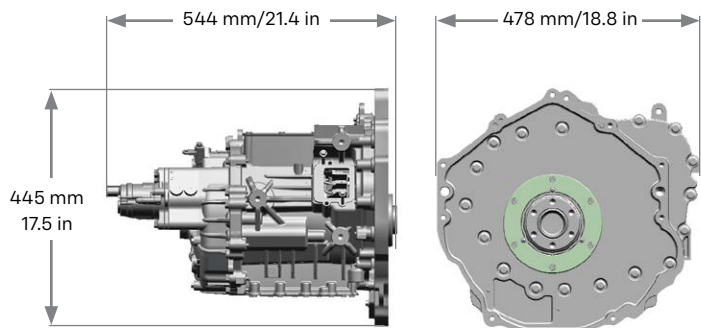

 This part is intended for competition use only. See page 2 for complete details.

eCRATE BATTERY PACK

The new Chevrolet Performance eCrate 66 kWh (400V) lithium-ion battery pack offers great power in a one-piece low-profile design that can be adapted to a variety of applications. It employs production-based thermal management and battery management systems, for easy plug-and-play operation with the available control modules.

SPECIFICATIONS:

Height at front:	7.3 in. (185 mm)
Height at rear:	13.7 in. (347 mm)
Overall width:	50.2 in. (1276 mm)
Overall length:	71.1 in. (1807 mm)
Weight:	947 lb. (430 kg)

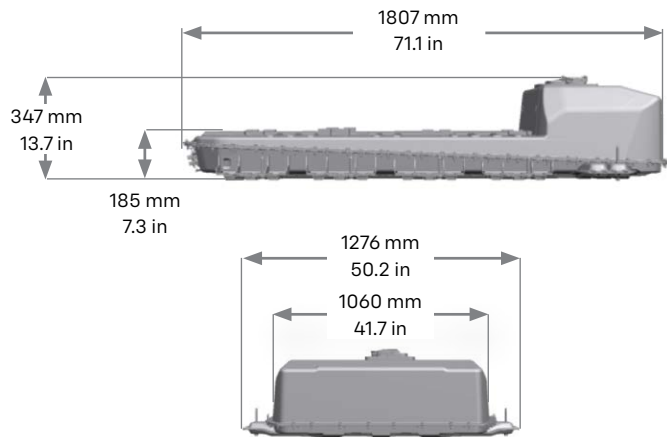

eCRATE CONTROL MODULES & ACCESSORIES

Along with the production-based battery pack and drive motor, engineers developed electrification propulsion kits for converting conventional combustion vehicles into fully electric vehicles.

They're designed with existing GM technology and components, providing builders with more of the components they need to complete a retro-fit installation and get the vehicle on the road sooner.

High-Voltage Power Electronics

- Power inverter
- On-board charger module
- Auxiliary power module
- High-power distribution module
- Battery heater
- Electric AC compressor
- Cabin heater

Low-Voltage Power Electronics

- Electronic control module and low-voltage harnesses
- Vehicle Integration Control Module
- Additional associated control modules

Additional Components & Accessories

- Charging receptacle
- Level 1 charge cord
- Accelerator pedal

Optional Components

- Power steering pump
- Brake vacuum pump
- Dual level charge cord set – P/N 85163382
- Installation kit for transmission – P/N19433630

NOTE: Information may vary with application. All specifications listed are based on the latest product information available at the time of publication. The right is reserved to make changes at any time without notice. ©2025 General Motors. All rights reserved. The marks appearing in this ad are the trademarks or service marks of GM, its subsidiaries, affiliates or licensors.

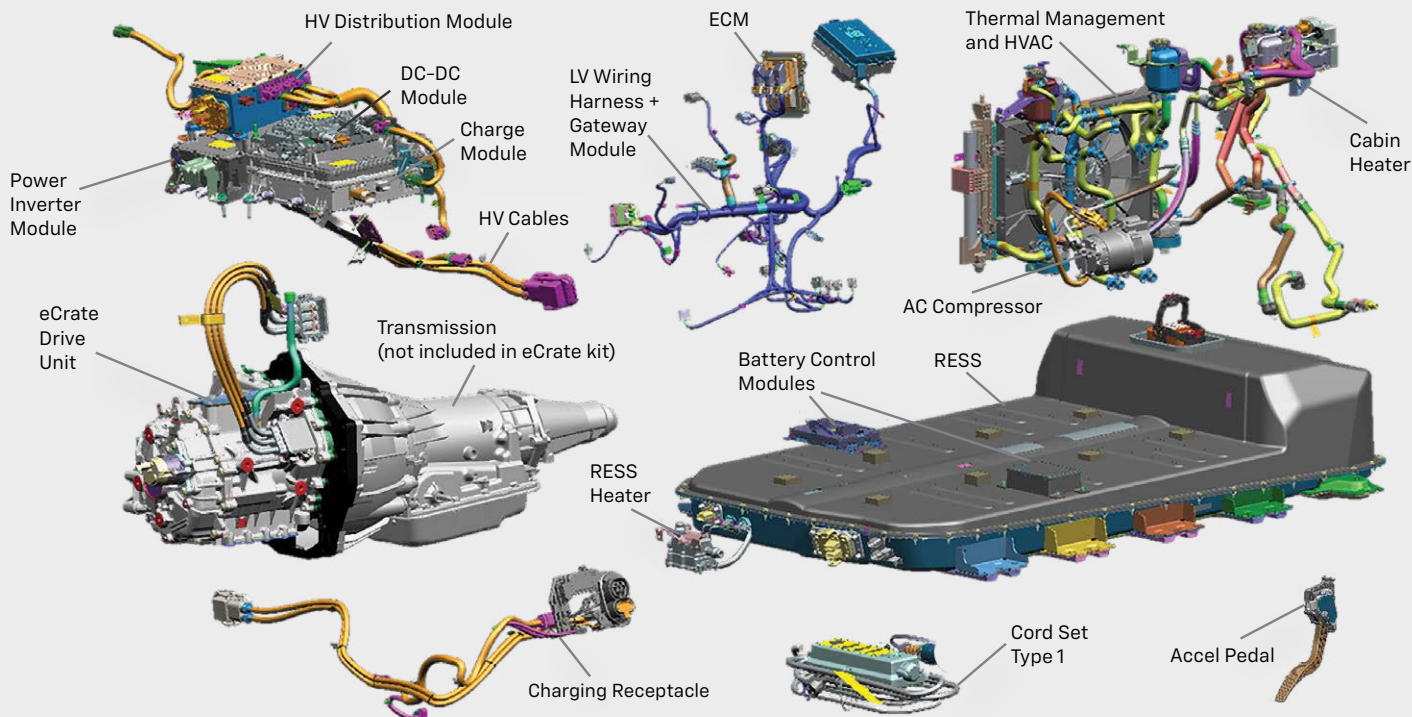



SMALL-BLOCK

LS-Series

Crate Engines



Engines shown from left:
LS376/515, LS364/450, LS3

Gen IV LS power for your project

Versatile, adaptable and offering almost unlimited potential from Chevrolet Performance's crate engines and performance parts, the LS engine family is a new standard for high-performance engine installations. Chevrolet Performance has the controller, with engine-specific calibration, and harness kit to help the installation go smoothly and get running quicker, without additional tuning.

Check out the following pages to find the Chevrolet Performance LS-Series Engine that's right for you!

LS3.....	52	LS376/525	60
LS364/450	54	DR525	62
LS376/480	56	LS9 LONG BLOCK	64
LS376/515	58		

NOTE: Engines may not come with all the parts shown in photo. See your dealer for more details.



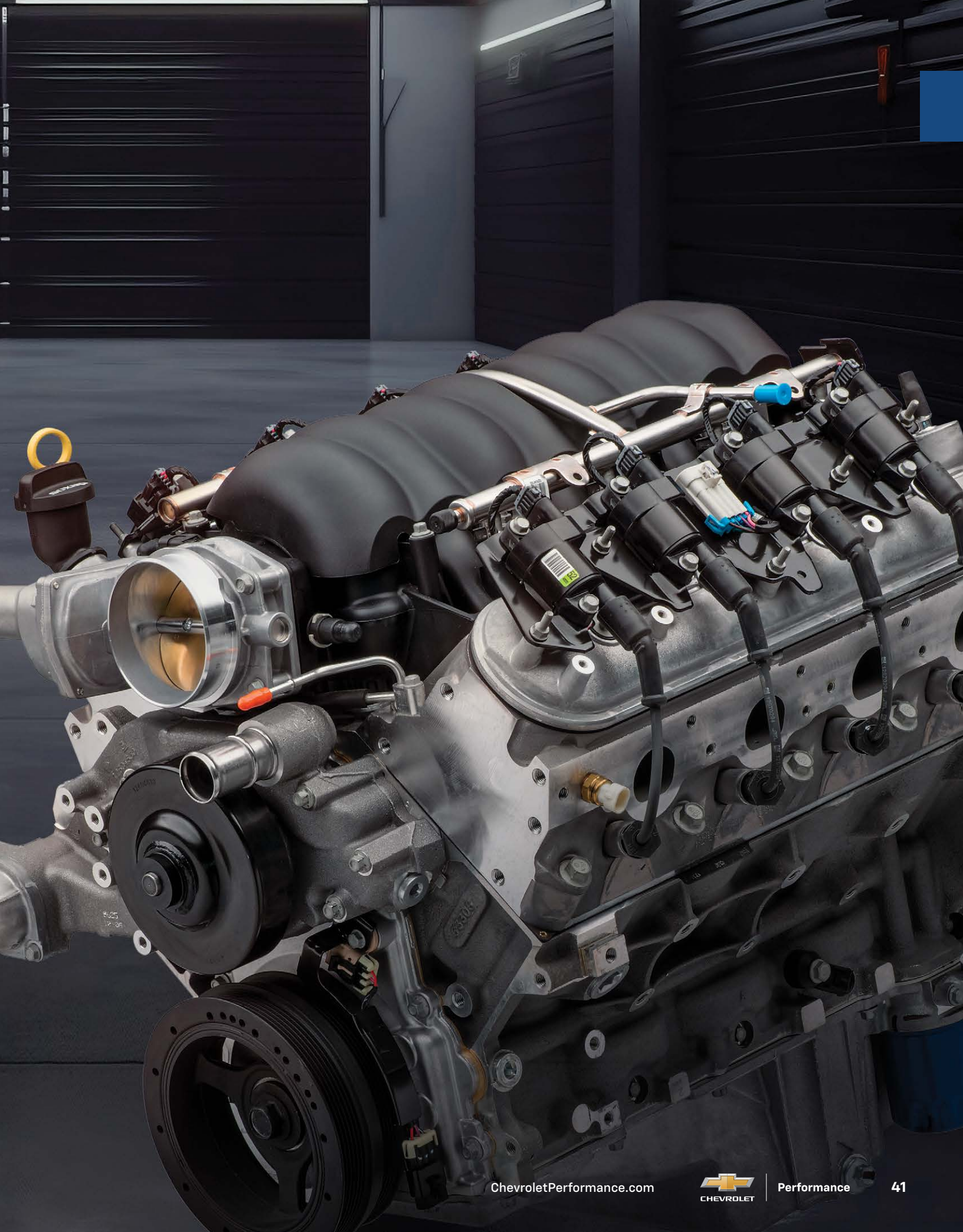

The LS/LT engine family tree

Everything you wanted to know about GM's 21st-century Small-Block, but were afraid to ask!

LS HERITAGE

The engine family commonly called the LS series debuted in 1997. General Motors called it the Gen III Small-Block, with the iron-block versions in trucks and the all-aluminum LS1 version introduced in the then-new C5 Corvette. A year later, the LS1 replaced the Gen II LT1 Small-Block in Camaros and Firebirds. The LS1 displaced 5.7 liters, similar to the previous-generation Small-Block, but the cubic-inch measurement differed slightly: 346 for the LS1 vs. the traditional 350 cubes.

In 1999, the Gen III platform spawned the higher-performance LS6 that was standard in the Corvette Z06. In 2005, the Gen IV branch of the LS family was born, differing from the Gen III with cast-in provisions for fuel-saving cylinder deactivation, larger displacements and revised camshaft sensing. The performance versions of the Gen IV include the LS2, LS3, LSA supercharged, LS9 supercharged and LS7.

GM has continued to refer to its modern V-8 engine family as Gen III and Gen IV, but to the enthusiasts who quickly grasped the tremendous performance potential of the engines, every engine based on the platform is nicknamed "LS." The range of production engines from the LS platform is wide. On the truck side, iron-block engines have included 4.8L and 5.3L versions, as well as all-aluminum 6.0L and 6.2L premium engines. Car engines include 5.3L, 5.7L, 6.0L, 6.2L and 7.0L displacements, including some configured for front-wheel drive.

GEN III VS GEN IV

Despite some significant differences between Gen III and Gen IV cylinder blocks, all LS engines share common traits that include:

- 4.400" bore centers (like the original Small-Block)
- 6-bolt, cross-bolted main bearing caps
- Center main thrust bearing
- 9.240" deck height
- 4-bolt-per-cylinder head bolt pattern
- 0.842" lifter bores
- Distributorless, coil-near-plug ignition system

The most distinguishing differences between Gen III and Gen IV cylinder blocks are larger bores (on some engines), different camshaft position sensor locations—front timing cover area on Gen IV blocks and top-rear position on Gen III blocks—and, on most Gen IV blocks, cast-in provisions for GM's Active Fuel Management cylinder deactivation system.

There is great interchangeability between all LS engines, including between Gen III and Gen IV versions. Cylinder heads, crankshafts, intake manifolds and more can be mixed and matched—but the devil is in the details. Not every head matches every intake manifold and not every crankshaft works with every engine combination. Will Handzel's "How to Build High-Performance Chevy LS1/LS6 V-8s"—P/N 88958786—is a great reference source that outlines the more specific differences and interchangeability among Gen III-based engines.

LS1/LS6

LS1 5.7L (346 cu in) engines were produced between the 1997 and 2004 model years in the United States (Corvette, Camaro, Firebird and GTO) and stretching into 2005 in other markets (primarily Australia). The LS6 was introduced in 2001 in the Corvette Z06 and was manufactured through 2005, where it also was found in the Cadillac CTS-V. The LS1 and LS6 share a 5.7L displacement, but the LS6 production engine uses a unique block casting with enhanced strength, greater bay-to-bay breathing capability and other minor differences. The heads, intake manifolds and camshaft also are unique LS6 parts.

LS2/L76/L77

In 2005, the LS2 6.0L (364 cu in) engine and the Gen IV design changes debuted. In GM performance vehicles, it was offered in the Corvette, GTO and even the heritage-styled SSR roadster. It was the standard engine in the Pontiac G8 GT (L76) and it was the V-8 offered in the Chevrolet Caprice Police Pursuit Vehicle (L77). This engine is one of the most adaptable in the LS family, as LS1, LS6, LS3 and L92/L94 cylinder heads work well on it.

LS3/L99

Introduced on the 2008 Corvette, the LS3 brought LS-based performance to an unprecedented level: 430 horsepower from 6.2L (376 cu in). The LS3 block not only had larger bores than the LS2, but a strengthened casting to support more powerful applications, including the LS9 supercharged engine of the Corvette ZR1. The LS3 was also the standard engine in the fifth-generation Camaro SS and was offered in the Pontiac G8 GXP. The L99 version was equipped with GM's fuel-saving Active Fuel Management cylinder deactivation system and was standard on fifth-gen Camaro SS models equipped with an automatic transmission. A unique version of the LS3 used in some Corvette Grand Sport applications incorporated a dry-sump oiling system.

LS4

Perhaps the most unique application of the LS engine in a car, the LS4 was a 5.3L version used in the front-wheel drive Chevrolet Impala SS and Pontiac Grand Prix GXP. The LS4 had an aluminum block and unique, low-profile front-end accessory system, including a "flattened" water pump, to accommodate the transverse mounting position within the Impala and Grand Prix. It was rated at 303 horsepower and 323 lb.-ft. of torque.

LS7

A legend in its own time, the LS7 was the standard engine in the C6 Corvette Z06 and fifth-generation Camaro Z/28. Its 7.0L displacement (427 cubic inches) made it the largest LS engine offered in production vehicles. Unlike LS1/LS6, LS2 and LS3 engines, the LS7 uses a Siamese-bore cylinder block design, which was required for its big 4.125-inch bores. Competition-proven heads and lightweight components, such as titanium rods and intake valves, made the LS7 a street-tuned racing engine with 505 horsepower. Chevrolet Performance's crate engine reflects the Camaro Z/28 version, which features a unique Tri-Y exhaust manifold design.

LS9

The LS9 was the 6.2L supercharged and charge-cooled engine of the C6 Corvette ZR1, rated at 638 horsepower. The LS9 used a strengthened 6.2L block with stronger Rotocast cylinder heads and a sixth-generation 2.3L Roots-type supercharger. Like the LS7, it used a dry-sump oiling system.

LSA

This supercharged 6.2L engine powered the 2009–2015 Cadillac CTS-V series and the 2012–2015 Camaro ZL1. Although similar to the LS9 in design, it was built with several differences, including hypereutectic pistons vs. the LS9's forged pistons and a smaller 1.9L supercharger. It also has an eight-bolt flywheel vs. the LS9's nine-bolt pattern. The LSA has a unique charge-cooler design on top of the supercharger, with differences between the Cadillac and Camaro ZL1 applications. It was rated at 556 horsepower in the CTS-V and 580 horsepower in the Camaro ZL1.

GEN III & GEN IV VORTEC TRUCK ENGINES

Although performance car engines have typically carried "LS" designations, truck engines built on this platform have been dubbed Vortec. They are generally distinguished by iron cylinder blocks and smaller displacements than car engines. Interestingly, a 5.7L Vortec "LS" engine has never been offered. Here's a quick rundown of the previous and current-production LS truck engines:

- 4.8L – The smallest-displacement LS engine (293 cu in); it uses an iron block with 3.78-inch bores and aluminum heads.
- 5.3L – The most common LS truck engine. It uses the same iron block with 3.78-inch bores as the 4.8L, but with a larger 3.62-inch stroke (327 cu in). Later versions equipped for Active Fuel Management and 2010-and-newer versions feature variable valve timing (cam phasing). Manufactured with iron and aluminum cylinder blocks.

Gen III, IV, Small-Block Crate Engines

Part Number	Description	Liters	CID	Block Material	HP	Torque	Bore	Stroke
19165628 (discontinued)	LS327/327	5.3	327	CI	327	347	3.780	3.622
17801267 (discontinued)	LS1	5.7	346	AL	350	365	3.898	3.622
19165484 (discontinued)	LS2	6.0	364	AL	400	400	4.000	3.622
19172842 (discontinued)	LS364/440	6.0	364	AL	440	404	4.000	3.622
19434650	LS364/450	6.0	364	CI	450	441	4.000	3.622
19416591 (discontinued)	L96	6.0	364	CI	360	380	4.000	3.622
19540156	LS376/480	6.2	376	AL	495	473	4.065	3.622
19435102	LS376/515	6.2	376	AL	533	477	4.065	3.622
19540157	LS376/525	6.2	376	AL	525	486	4.065	3.622
19540155	LS3	6.2	376	AL	430	425	4.065	3.622
19370850 (discontinued)	LSA	6.2	376	AL	556	551	4.065	3.622
19260165 (discontinued)	LS9	6.2	376	AL	638	604	4.065	3.622
19434598*	CT525	6.2	376	AL	533	477	4.065	3.622
19329246 (discontinued)	LS7	7.0	427	AL	505	470	4.125	4.000
19421004 (discontinued)	LS427/570	7.0	427	AL	570	540	4.125	4.000
19432776	LSX376 B-8	6.2	376	CI	476	475	4.060	3.622
19417356	LSX376 B-15	6.2	376	CI	473	444	4.060	3.622
19417357	LSX454	7.4	454	CI	627	586	4.185	4.125
19331506 (discontinued)	LSX454R	7.4	454	CI	776	649	4.185	4.125

*For circle-track racing only. Not for street use.

- 6.0L – Used primarily in $\frac{3}{4}$ -ton and 1-ton trucks, the 6.0L (364 cu in) uses an iron block (LY6) or aluminum block (L76) and aluminum heads, with provisions for Active Fuel Management; some are equipped with variable valve timing.
- 6.2L – Commonly referred to by its L92, L9H or L94 engine codes, the 6.2L (376 cu in) engine uses an aluminum block and heads and incorporates advanced technology, including variable valve timing. The L92 is used primarily as a high-performance engine for the Cadillac Escalade and GMC Yukon Denali.

MORE ABOUT THE VORTEC 5.3L

With more than 10 years in service in millions of Chevy and GMC trucks, vans and SUVs, the Vortec 5.3L engine is poised to become the classic 350 Small-Block of the LS engine family. With millions in service, it is readily available and affordable on the used-engine market. Most feature iron cylinder blocks, but some have an aluminum engine block that is about 80 pounds lighter. Adapting a 5.3L to a hot rod project is easier with Chevrolet Performance's 5.3L controller kit, P/N 19369180. It covers 2007–2009 applications (non-cam-phased) with the following engine codes:

- LC9 (2007–2009) • LH8 (2008–2009) • LMG (2007–2009)
- LY5 (2007–2009) • LMF (2008–2009)

LSX CRATE ENGINES

Chevrolet Performance LSX Series of crate engines is based on the LSX Bowtie Block and uses a number of production-based and LSX high-performance parts to deliver ultimate-performance engines that were never offered in production vehicles. They include:

- LSX376-B8 – An economical crate engine that uses the LSX block, LS3 rotating parts and the LS3 cylinder heads. It is offered without an oil pan or induction system, so that it can be tailored for the project vehicle.
- LSX376-B15 – Designed to accommodate additional power adders or boost up to 15 PSI. Includes forged pistons, forged crank and 6-bolt LSX-LS3 cylinder heads.
- LSX454 – The displacement of the classic Big-Block, with an all-forged rotating assembly and LSX-LS7 six-bolt cylinder heads. It is rated at 627 hp with a carburetor and 580 with an LS7 fuel injection system.
- LSX454R – A high-compression (13.1:1) version of the LSX454 designed for drag racing, featuring a mechanical roller cam, high rise intake and more. It is capable of more than 750 horsepower.

NOTE: Discontinued in 2018 (N/A)

NON-PRODUCTION CYLINDER BLOCKS

C5R: Developed for the factory-backed Corvette racing program, the C5R cylinder block has been manufactured in comparatively small quantities since 2000. They are manufactured with a unique aluminum alloy for greater strength and undergo a variety of specialized machining and inspection processes, including "hipping" to increase strength and X-raying that ensures against unacceptable porosity. A Siamese bore design with 4.117-inch finished bores enables 7.0L (427 cu in) displacements. The C5R uses billet steel main caps with premium 4340 fasteners. Racing-quality head studs are also included. All LS series heads will work with the C5R block, but maximum performance depends on maximum airflow.

LSX Bowtie Block (standard and tall-deck): Introduced in 2007, the LSX Bowtie Block is a durable and affordable cast-iron casting that was designed to support extreme high-performance combinations, including provisions for six-bolts-per-cylinder head fastening. It has a Siamese bore design with 3.880-inch bores that must be finished to 3.898 inches, with a 4.200-inch recommended maximum bore. Maximum stroke can reach 4.25 inches, but rotating assembly interference on the cylinder must be taken into account for strokes greater than 4.125 inches. Heavy metal is required for crankshaft balancing of larger-stroke combinations. Standard versions feature decks 0.020-inch taller than LS production blocks, with the tall-deck version manufactured with a 9.720-inch semi-finished deck height. The oiling system is a true priority-main system and all LS Small-Block heads work with the engine. Higher-airflow heads, such as LS7, LSX-DR, LSX-CT and C5R, are recommended.

CRANKSHAFTS

Generally, LS crankshafts are similar in design, with identical 2.100-inch rod and 2.560-inch main journal sizes and a common rear main seal. All LS engines use iron crankshafts except the LS7, LS9, LSA and LSX454; they use forged steel cranks (4.00-inch stroke on the LS7; 3.62-inch stroke on the LS9 and LSA; and 4.125-inch on the LSX454).

The crankshaft sensing function of the distributorless ignition system depends on reading the toothed reluctor wheel on the crankshaft. Early LS engines mostly used 24-tooth (also known as 24Xe) wheels and upgraded a few years ago to 58-tooth (also known as 58X) wheels. When building an LS engine, it is imperative the correct reluctor wheel is used with the compatible crankshaft position sensor and ignition controller.

The crankshafts are mostly interchangeable, but the snouts on LS7 and LS9 crankshafts are approximately 1 inch longer to accommodate their two-stage oil pumps, which work with the engines' dry-sump oiling systems. The same goes for certain Corvette applications of the LS3, which was available with a dry-sump system as well. These forged crankshafts can be used on wet-sump engines by using a few specific components and/or modifications.

The LS/LT engine family tree continued on next page

LS-SERIES CRATE ENGINES

The LS/LT engine family tree continued



A Cathedral Intake Port and Bolt Pattern



B LS3 Intake Port and Bolt Pattern

CYLINDER HEADS – INTAKE PORT DESIGN

Cylinder head interchangeability enables great parts-mixing to build custom LS engine combinations, but the heads must be matched with intake manifolds that have compatible intake port configurations. The port sizes and shapes include:

Cathedral port

Introduced on the LS1 engine and used also on the LS6 and LS2, cathedral-port heads are named for the unique shape of the top of the intake port. Intake manifolds for LS1, LS2, LS6 and Vortec engines with cathedral-port heads are mostly interchangeable. (Photo A)

Rectangular port – LS7-style

The second LS intake runner design debuted on the Corvette Z06's LS7 engine. This rectangular design supports the straight-through airflow design of the heads. They feature 270cc intake ports and the ports and combustion chambers are CNC-ported from the factory. Use only with the LS7 intake manifold. The LSX-LS7 head features the same port design, but with six-bolt clamping vs. the production four-bolt pattern. (Photo C)

Rectangular port – L92/LS3 style

Similar to the LS7 design, but the ports are a little taller and a little narrower. They flow more than cathedral-port heads, but not as much

as LS7 heads. In addition to the L92 6.2L engines, this port shape is also used on LS3 engines and some 6.0L truck engines, as well as the Corvette ZR1's LS9 and Cadillac CTS-V's LSA supercharged engines. Intake manifold bolt patterns are unique to this port design. (Photo B)

C5R heads

These heads pioneered the rectangular-port design, but because they are designed for professional finishing, their final shape and size depends on whomever is performing the porting (not shown).

CYLINDER HEADS – VALVES AND RECOMMENDED APPLICATIONS

Each LS cylinder head has specific valve sizes, locations and valve angles. Here's an overview of them:

Cathedral-port heads

Designed for smaller-displacement engines, these heads have the smallest valves: 2.000-inch intake and 1.500-inch exhaust. They're held at a 15-degree angle. They also have the closest valve spacing, which limits the maximum valve size. LS6 valves include lightweight hollow-stem intake and sodium-filled exhaust parts; all others in this family feature solid-stem construction. (Photo A)

LS Compatibility—Heads vs. Intakes

INTAKES				HEADS						
Engine	Part Number	Manifold Type	Port Type	12559855 Std LS1	12564824 (discon.) Std LS6/LS2	12562319 Std LQ9	88958622 (discon.) CNC LS6	12711770 Std L76/L92	12675871 Std LS3	88958758 (discon.) CNC LS3
LS1/LS6	88894339 (discon.)	EFI	Cathedral	Yes	Yes	Yes	Yes	No	No	No
LS2/LQ4	88958675	4-bbl	Cathedral	Yes	Yes	Yes	Yes	No	No	No
LS3	19540154	EFI	L92	No	No	No	No	Yes	Yes	Yes
L92/LS3	25534416	4-bbl w/inj	L92	No	No	No	No	Yes	Yes	Yes
L92/LS3	25534401	4-bbl	L92	No	No	No	No	Yes	Yes	Yes
L92/LS3	19354473 (discon.)	LSX 4-bbl	L92	No	No	No	No	Yes	Yes	Yes
L92/LS3	19354469 (discon.)	LSX 4-bbl	L92	No	No	No	No	Yes	Yes	Yes
LS7	12644568 (discon.)	EFI	LS7	No	No	No	No	No	No	No
LS7	25534413 (discon.)	4-bbl w/inj	LS7	No	No	No	No	No	No	No
LS7	25534394	4-bbl	LS7	No	No	No	No	No	No	No
LSX-CT	19354481 (discon.)	LSX 4-bbl	LSX-CT	No	No	No	No	No	No	No
LSX454R	19354475 (discon.)	LSX 4-bbl	LSX-DR	No	No	No	No	No	No	No

No=not compatible Yes=direct compatibility



C LS7 Intake Port and Bolt Pattern



D LSX-CT and LSX-DR Ports

L92/LS3 heads

Similar in design to the LS7 head, the L92 heads don't flow quite as much and the valves are correspondingly smaller: 2.165-inch on the intake side and 1.590-inch on the exhaust side. They are held at a 15-degree angle and also require offset rocker arms. These heads/valves require at least a 4.00-inch bore, but work best on an engine with a 4.065-inch bore. Valve-to-piston clearance must be checked when using them on an engine originally equipped with cathedral-port heads. (Photo B)

LS7 heads

Using LS-Series' largest production valves—2.200-inch on the intake side and 1.610-inch on the exhaust—the LS7 heads offer tremendous airflow, but they require an engine with no less than 4.100-inch bores. The intake valves are made of titanium and the exhaust valves are sodium-filled; they are held at a 12-degree angle. That and their large size require offset rocker arms on the intake side. Valve-to-piston clearance must be checked when using these heads with pistons not designed for the LS7 engine. (Photo C)

C5R

Designed for engines with at least 4.125-inch bores, these heads can accommodate 2.200-inch intake and 1.650-inch exhaust valves; they are held at an 11-degree angle and their spacing is unique. When used on an engine not originally designed for C5R pistons, valve-to-piston clearance must be checked. (not shown)

LSX-CT and LSX-DR

CT and DR are in-line heads, with a valve angle of 11 degrees. The CT head was designed specifically for 410 CID sprint car applications, with 2.200-inch intake and 1.610-inch exhaust valve sizes and valve placement modified and optimized for 4.125-inch bores. DR heads were designed for 410-plus CID, high-rpm drag racing applications. Valve placement was spread from the CT to allow up to 2.280-inch and 1.620-inch valves. Larger valve sizes require a 4.165-inch minimum bore. (Photo D)

The LS/LT engine family tree continued on next page

LS Compatibility—Heads vs. Intakes (continued)

Engine	Part Number	INTAKES		HEADS						
		Manifold Type	Port Type	19354245 (discon.) LSX-L92 Small Bore	19419187 LSX-LS3	19419190 LSX-LS9	12578450 Std CNC LS7	19419193 LSX-LS7	19330896 LSX-CT (discon.)	19330894 LSX-DR (discon.)
LS1/LS6	88894339 (discon.)	EFI	Cathedral	No	No	No	No	No	No	No
LS2/LQ4	88958675	4-bbl	Cathedral	No	No	No	No	No	No	No
LS3	19540154	EFI	L92	Yes	Yes	Yes	No	No	No	No
L92/LS3	25534416	4-bbl w/inj	L92	Yes	Yes	Yes	No	No	No	No
L92/LS3	25534401	4-bbl	L92	Yes	Yes	Yes	No	No	No	No
L92/LS3	19354473 (discon.)	LSX 4-bbl	L92	Yes	Yes	Yes	No	No	No	No
L92/LS3	19354469 (discon.)	LSX 4-bbl	L92	Yes	Yes	Yes	No	No	No	No
LS7	12644568 (discon.)	EFI	LS7	No	No	No	Yes	Yes	No	No
LS7	25534413 (discon.)	4-bbl w/inj	LS7	No	No	No	Yes	Yes	No	No
LS7	25534394	4-bbl	LS7	No	No	No	Yes	Yes	No	No
LSX454	19354465 (discon.)	LSX 4-bbl	LS7	No	No	No	Yes	Yes	No	No
LSX-CT	19354481 (discon.)	LSX 4-bbl	LSX-CT	No	No	No	No	No	Yes	Yes
LSX454R	19354475 (discon.)	LSX 4-bbl	LSX-DR	No	No	No	No	No	Yes	Yes

No=not compatible Yes=direct compatibility

LS-SERIES CRATE ENGINES

The LS/LT engine family tree continued



A LS6 Rockers



B L92 Rockers

VALVETRAIN

LS-Series valvetrain systems are very universal. All production engines use investment-cast rockers with roller trunnions. They attach to a bolt-down mounting bracket (except for LS7 and LSX applications that have machined pedestals) that makes installation fast and easy. All production engines feature 1.7-ratio rockers, except the LS7, which uses 1.8-ratio rockers. Rockers are specific to their cylinder head families. Here's a look at the various applications:

Cathedral-port heads

Use interchangeable rockers on the intake and exhaust sides P/N 12681275. (Photo A)

L92/LS3 heads

Use specific, offset intake rockers P/N 12696105 and non-offset exhaust rockers P/N 12681275. (Photo B)

LS7 heads

Use specific, offset intake rockers P/N 12579615 and non-offset exhaust rockers P/N 12579617. (Photo C)

LSX-SC heads

Designed for LS7-style offset intake rockers P/N 12579615 and non-offset exhaust rockers P/N 12579617, but can be machined for shaft-mount rocker system. (Photo D)

LS Compatibility—Heads vs. Blocks

Engine	BLOCKS		HEADS						
	Part Number	Bore Size	12559855 (discon.) Std LS1	12564824 (discon.) Std LS6/LS2	12562319 Std LQ9	88958622 (discon.) CNC LS6	12711770 Std L76/L92	12675871 Std LS3	88958758 (discon.) CNC LS3
LS1/LS6	12561166 (discon.)	3.890"	Yes	Yes	Yes	Yes	No	No	No
LS2/L76	12602691 (discon.)	4.000"	Yes	Yes	Yes	Yes	Yes	Yes	Yes
L92/LS3	12729604	4.065"	Yes	Yes	Yes	Yes	Yes	Yes	Yes
LSA	12673476	4.065"	Yes	Yes	Yes	Yes	Yes	Yes	Yes
LS9	12623969 (discon.)	4.065"	Yes	Yes	Yes	Yes	Yes	Yes	Yes
LS7	19213580 (discon.)	4.125"	Yes	Yes	Yes	Yes	Yes	Yes	Yes
C5R	12480030 (discon.)	4.120"–4.160"	Yes	Yes	Yes	Yes	Yes	Yes	Yes
LSX Std. Deck ¹	19417351	3.890"	*	*	*	*	*	*	*
LSX Tall Deck ¹	19417354	3.890"–4.200"	*	*	*	*	*	*	*
LSX376	19417352	4.085"	Yes	Yes	Yes	Yes	Yes	Yes	Yes
LSX454	19417353	4.185"	Yes	Yes	Yes	Yes	Yes	Yes	Yes

No=not compatible Yes=direct compatibility *4.00" minimum bore

¹LSX Semi-Finished - needs finish bore/hone and deck height machined

BUILDERS TIP

Ensuring Windage Tray Clearance on LS Engines

When building a custom LS engine combination, care must be taken to make sure the connecting rods don't interfere with the windage tray. To do that, set the windage tray over the installed rotating assembly carefully and rotate the crankshaft. If any of the connecting rods touch the tray, you'll have to use a specially designed windage tray for longer-stroke cranks.



C LS7 Rockers



D LSX-SC Rocker Mounting Stand Pads

HEAD-TO-BLOCK COMPATIBILITY

Because of their comparatively small bores—3.89 inches—LS1 and LS6 engines can only use LS1, LS6 and LS2 heads. Using heads designed for larger engines will cause valve-to-block interference. The larger 4.00-inch bore of the LS2 enables it to use LS1/LS6 heads as well as L92-style heads (including LS3, LS9 and LSA engines). The 6.2L engines (LS3, L92, etc.) can use any head, except for the LS7 and C5R, while the 7.0L LS7 and C5R blocks can use any LS-series head. LS7 blocks should be matched with heads designed for at least 4.10-inch bores; 4.125-inch bores are preferred.

Most LS production cylinder blocks share the same cylinder head bolt pattern and the same size head bolts—four 11mm bolts per cylinder (20 in total) and five upper 8mm bolts. Early LS1 and LS6 engines used different-length 11mm bolts, but engines from 2004 and later use same-length bolts. LS9 engines use stronger 12mm head bolts.

Non-production blocks, such as Chevrolet Performance’s LSX block and the C5R, offer the same head-bolt pattern as production blocks. All LS heads will bolt up to them, but care must be taken to select the most compatible heads based on the appropriate bore size. Because of their large bores, heads designed for at least 4.10-inch bores should be used and 4.125-inch bores are preferred, such as the L92/LS3 or LS7 heads.

Chevrolet Performance’s LSX cylinder heads use ten 11mm and thirteen 8mm head bolts, or eight more than a regular-production LS head. That’s more than 50 percent more head bolts than production heads, supplying superior clamping strength.

All cylinder heads used with the LSX tall-deck block require the appropriate intake manifold designed for tall-deck applications because the higher deck of the block widens the dimension between the heads’ manifold-mounting positions.

The LS/LT engine family tree continued on next page

LS Compatibility—Heads vs. Blocks (continued)

Engine	BLOCKS		HEADS						
	Part Number	Bore Size	19354245 (discon.) LSX-L92	19419187 LSX-LS3	19419190 LSX-LS9	12578450 Std CNC LS7	19419193 LSX-LS7	19330896 (discon.) LSX-CT	19330894 (discon.) LSX-DR
LS1/LS6	12561166 (discon.)	3.890"	Yes	No	No	No	No	No	No
LS2/L76	12602691 (discon.)	4.000"	Yes	Yes	Yes	No	No	No	No
L92/LS3	12729604	4.065"	Yes	Yes	Yes	No	No	No	No
LSA	12673476 (discon.)	4.065"	Yes	Yes	Yes	No	No	No	No
LS9	12621983 (discon.)	4.065"	Yes	Yes	Yes	No	No	No	No
LS7	19213580 (discon.)	4.125"	Yes	Yes	Yes	Yes	Yes	Yes	Yes
C5R	12480030 (discon.)	4.120"–4.160"	Yes	Yes	Yes	Yes	Yes	Yes	Yes
LSX Std. Deck ¹	19417351	3.890"	**	**	**	**	**	**	**
LSX Tall Deck ¹	19417354	3.890"– 4.200"	**	**	**	**	**	**	**
LSX376	19417352	4.085"	Yes	Yes	Yes	No	No	No	No
LSX454	19417353	4.185"	Yes	Yes	Yes	Yes	Yes	Yes	Yes

No=not compatible

Yes=direct compatibility

*4.00" minimum bore

**4.125" minimum bore

¹LSX Semi-Finished - needs finish bore/hone and deck height machined

BUILDERS TIP

Priming the LS Engine

If you’re used to building classic Small-Block and Big-Block engines, you’ve probably used an electric drill or similar tool in the distributor hole to drive the oil pump and prime the engine prior to start-up. LS engines don’t use distributors, so engine priming must be performed in other ways. First of all, fill the oil pump pickup with oil when assembling the engine. That will ensure a quantity of oil is in the pump when the engine is started for the first time. Also, disconnect either the fuel supply or ignition system when it’s time to start the engine and allow the engine to “roll over” for approximately 30 seconds. That allows oil to circulate through the engine without the engine running. Removing spark plugs will allow the engine to prime faster with less load on the bearings. Then reconnect the fuel or ignition and fire up your LS engine!

The LS/LT engine family tree continued

SPECIAL NOTE ABOUT CRANKSHAFT BOLT PATTERNS

Almost all LS-engine crankshafts use a 6-bolt flywheel/flexplate bolt pattern, but the LS9 uses a 9-bolt pattern and the LSA, LT1, LT4, L8T, L8P and LSX454 engines use an 8-bolt pattern.

CONNECTING RODS

LS connecting rods are very similar and interchangeable. Most are made of forged powdered metal, while the LS7 and LS9 rods are forged titanium. The LS9 rods feature a unique forging designed for the pressure and power level of forced induction. Rod lengths are similar, too, at 6.098 inches for 5.3L, 5.7L, 6.0L and 6.2L (including LSA) engines. The 4.8L engine uses 6.275-inch rods and the LS7 uses 6.067-inch rods. The LS9 uses 5.990-inch rods. Since 2006, LS rods use bushed small ends.

PISTONS

The LS9 is the only production LS engine with forged aluminum pistons; all the others use hypereutectic (cast) aluminum alloy pistons, varied mostly by diameter to accommodate various bore sizes. LS cast pistons shouldn't be used on applications greater than approximately 550 horsepower. Also, the LS7 piston's inner bracing requires the use of the matching LS7 connecting rod.

GEN V SMALL-BLOCK: ENTER THE "LT" ENGINES

Introduced on the seventh-generation C7 Corvette Stingray and GM's full-size trucks and SUVs for 2014, the Gen V Small-Block ushered in the next era of the historic engine family.

The Gen V engine family delivers greater efficiency, performance and durability thanks to a combination of advanced technologies—including direct injection, Active Fuel Management (cylinder deactivation) and camshaft phasing (variable valve timing)—that support an advanced combustion system. In 2020 the 6.6L V8 L8T was introduced for use in the Heavy-Duty pickup trucks. It is part of GM's fifth-generation Small Block engine family and made its debut in the all-new 2020 Chevrolet Silverado HD and 2020 GMC Sierra HD. The L8T is built on a cast-iron Small Block, enabling it to have long-term durability. Aluminum heads and direct injection enable the engine to deliver more precise fuel control resulting in a higher compression ratio of 10.8:1. The L8T features a forged steel crankshaft, forged powder-metal connecting rods and additional high-strength components to provide the added strength and durability demanded by Heavy Duty customers. The L8T replaced the 6.0L V8 L96 engine and makes over 11 percent more horsepower and over 21 percent more torque.

In 2024 GM Performance Engineering took the L8T to another level and launched the L8P. The L8P shares many of the defining characteristics of the L8T, including total displacement 6.6L. The L8P powerplant features a unique non-AFM camshaft based off the 6.2L V8 LT2 found in the Corvette Stingray. To accommodate the special camshaft, more performance-oriented intake/exhaust valves and springs were added and the piston material was upgraded. By combining the heavy-duty durability of the Silverado HD and Sierra HD trucks with the all-out performance of the C8 Stingray, Chevrolet Performance has created a powerplant that is capable of satisfying many horsepower-hungry enthusiasts.

Structurally, the Gen V small-block is similar to the Gen III/IV engines, including a deep-skirt cylinder block. Refinements and new or revised components are used throughout, including a revised cooling system and all-new cylinder heads. The engine is also designed to accommodate an engine-driven high-pressure fuel pump for the direct-injection system.

As builders adapt the LT1, L8T, L8P or the supercharged LT4 or LT5 variant to their project cars, it's logical to ask about the differences between the LS family and the new LT engines and whether parts interchangeability is as easy—or even possible—as it was between the Gen III and Gen IV engines.

The short answer is no. Despite significant similarities in the basic architecture, there are a number of key differences between the new LT family and the LS family that prohibit simple interchangeability.

Here's a look at how the LT and LS families differ in those key areas, comparing the LT1 to the LS3. Most of the LT1 features match the

features on the supercharged LT4 and the LT5. Note: L8T and L8P have a cast-iron block.

NOTE: While structurally similar, almost none of the parts and components from the Gen V are interchangeable with Gen III and Gen IV engines.

CYLINDER BLOCK AND OILING SYSTEM

Like every Small-Block generation before it, the Gen V cylinder block shares a 90-degree cylinder angle and 4.400-inch bore centers. The LT1, LT4 and LT5 bore and stroke dimensions are 4.065-inches x 3.62-inches—the same as the LS3. Note: The L8T and L8P bore and stroke dimensions are 4.065-inches x 3.860-inches. Compared to the Gen IV versions, the Gen V's (LT1, LT4 and LT5) aluminum cylinder block casting is all new but based on the same basic architecture. The L8T and L8P have a cast-iron block casting. It was refined and modified to accommodate the mounting of the engine-driven fuel pump and vacuum pump. It also incorporates new engine mount attachments, new knock sensor locations, improved sealing and oil-spray piston cooling.

The oiling system is revised and features a new dual-pressure-control and variable-displacement vane pump with increased flow capacity. As with the Gen III/Gen IV engines, the oil pump is driven by the crankshaft. Variable displacement enables the pump to efficiently deliver oil flow as demanded.

All Gen V engines feature oil-spray piston cooling, in which oil-spraying jets in the engine block drench the underside of each piston and the surrounding cylinder wall with an extra layer of cooling, friction-reducing oil.

CAMSHAFT DESIGN AND CAMSHAFT PHASING

As with the LS3, the LT1, LT4, LT5, L8T and L8P use a hydraulic roller-lifter camshaft. It is also located in the same position relative to the crankshaft as the LS3, but, importantly, the LT1, LT4, LT5, L8T and L8P camshafts feature an all-new "trilobe" at the rear to drive the engine-mounted, high-pressure fuel pump for the direct-injection combustion system. There's no such extra lobe on the LS3 camshaft, which negates cam swaps between the engines.

Camshaft phasing (variable valve timing), which works with Active Fuel Management to enhance fuel economy, optimizes engine performance for given demands and conditions. Note: both the L8T and L8P are non-AFM.

ROTATING ASSEMBLY AND WINDAGE TRAY

Within the LT engine block is a durable rotating assembly that includes a strong forged steel crankshaft and 6.098-inch-long, powder-metal connecting rods, as well as high-strength hypereutectic pistons.

NOTE: LT4 and LT5 use forged aluminum pistons.

Most LS3 production engines have an admittedly tough nodular iron crankshaft that is known to support high horsepower levels, even under higher boost levels. The crankshafts in C6 Corvette models with the Z51 handling package included a dry-sump oiling system that necessitated a longer crank snout to accommodate the unique oil pump. Those cranks were forged steel.

The LT engines 6.125-inch connecting rod length is the same length as the LS3, but the profile of the rod itself is slightly different to enhance strength.

As for the piston design, the LS3 features conventional flat-top design, while the LT1, LT4, LT5, L8T and L8P have a unique head topography that is essential to the direct injection system. The "bowl" and shape of the top of the piston head is designed to promote thorough mixing of the air and fuel. A dish center section helps direct the fuel spray from the injector, which protrudes into the combustion chamber rather than into the intake manifold on the LS3's conventional port injection design.

The crankshaft in the LT1, LT4, LT5, L8T and L8P is located with nodular main bearing caps, which is a significant upgrade over the LS3's conventional gray iron main caps. They're stronger and can better absorb vibrations and other harmonics to help produce smoother, quieter performance. They also maintain the optimal crankcase "windows" that were perfected on the LS3's Gen IV architecture.

Redesigned windage trays were incorporated in the LT1, LT4, LT5, L8T and L8P, these feature a unique oil scraper designed to enhance performance and efficiency by improving oil flow control and bay-to-bay crankcase breathing.

CYLINDER HEAD DESIGN

The Gen V's all-new cylinder head design builds on the excellent, racing-proven airflow attributes of previous Small-Block heads. Its all-new direct-injection combustion system supports tremendous airflow at higher rpm for a broad horsepower band, along with strong, low-rpm torque.

Compared to the LS3 cylinder head design, the LT1 head features a smaller 59cc combustion chamber, which is designed to complement the volume of the piston dish. The smaller chamber size and dished pistons work together to produce an 11.5:1 compression ratio vs. the LS3's 10.7:1 compression ratio. The L8T and L8P also share the same head features with a 59cc combustion chamber and carry a 10.8:1 compression ratio. The LT4 and LT5 have a 65cc combustion chamber along with a 10:1 compression ratio.

The spark plug angle and depth have been modified on the Gen V head, too, to protrude farther into the chamber, placing the electrode closer to the center of the combustion to support the direct injection system. In addition to the new combustion chamber design, the Gen V head features large, straight and rectangular intake ports that feature a slight twist to enhance mixture motion. This is complemented by a reversal of the intake and exhaust valve positions as compared to the Gen III/IV design. The exhaust port shapes are optimized for the new valve locations, with new port opening locations at the manifold face.

VALVES AND VALVETRAIN

Large, lightweight intake and exhaust valves are used in the LT1, and L8P heads, with 2.13-inch hollow intake and 1.59-inch hollow sodium exhaust valves. The L8T head uses a 2.13-inch hollow intake and a 1.59-inch inconel exhaust valve. The LT4 and LT5 head use a 2.13-inch Titanium intake valve and 1.59-inch hollow sodium exhaust valves. The lightweight valves enable the engine to rev quickly and capably to greater than 6,000 rpm. LS3 valves measure 2.165 inches intake and 1.59 inches exhaust.

Roller-pivot rocker arms are used in the LT1, LT4, LT5, L8T and L8P and feature a 1.8 ratio vs. the 1.7 ratio of LS3 rockers. The LT engines reversed valve location also eliminates the offset design of the LS3's intake-side rocker arms. Also: the LT engines use 8.7mm (outside diameter) pushrods, which provide greater stiffness than the LS3's 7.9mm design. That enables improved high-speed valve-train performance.

DIRECT INJECTION FUEL SYSTEM

Direct injection is featured on all Gen V engines. The technology moves the point where fuel feeds into an engine closer to the point where it ignites, enabling greater combustion efficiency. It fosters a more complete burn of the fuel in the air-fuel mixture, and it operates at a lower temperature than conventional port injection. That allows the mixture to be leaner (less fuel and more air), so less fuel is required to produce the equivalent horsepower of a conventional port injection fuel system.

This represents one of the fundamental differences between the engines. The LT engines feature direct injection, with injectors positioned in the cylinder heads, while the LS3 features a conventional port injection system, with injectors located in the intake manifold. That difference alone makes it impossible to simply swap heads and intakes between the LT and LS families.

The pistons play an integral role in the direct injection system, as they feature dished heads designed to direct the fuel spray for a more complete combustion. Design of this advanced combustion

system was optimized after thousands of hours of computational analysis, representing one of the most comprehensively engineered combustion systems ever developed by General Motors.

The direct injection system features very high fuel pressure, up to 2,175 psi (15 MPa) on most engines and as high as 2,900 psi (20 MPa) on the supercharged LT4 and LT5 variant, requiring a high-pressure, engine-driven fuel pump in addition to a conventional fuel-tank-mounted pump. On all Gen V engines, the pump is mounted in the "valley" between cylinder heads—beneath the intake manifold. It is driven by the camshaft at the rear of the engine.

LT-SPECIFIC FEATURES

In addition to the features that compare with the LS3, the LT engines have a number of unique components that simply aren't shared with previous LS engines, including:

- PCV-integrated rocker covers designed to reduce oil consumption
- Cylinder deactivation that shuts down four cylinders in certain light-load driving conditions—and featuring unique, "collapsible" valve lifters for the deactivating cylinders
- Four-into-one short-header-type exhaust manifolds similar to the LS7 design, but made of cast iron
- Single-bore 87mm throttle body
- Revamped cooling system with a new offset water pump design
- The use of electric power steering on production models means there's no provision for a conventional power steering pump on the accessory drive system.

In summary, the lineage between the LS3 and the LT engines is clear, but where the LS3 was an evolution of previous LS engines, the LT engines are more of a new species. Therefore, mixing and matching parts between the LT and LS families isn't practical or, in most cases, feasible.

LT 6.2L

It's the standard engine in the C7 Corvette Stingray and Camaro SS, where it is rated at up to 460 horsepower and 465 lb.-ft. of torque (with the optional exhaust system). It shares the same basic configuration and 4.065 x 3.622 bore/stroke dimensions as the L86, but features other unique components to generate its higher output.

LT4 6.2L SUPERCHARGED

The supercharged LT4 engine is the power behind the C7 Corvette Z06, the Camaro ZL1 and the Cadillac CTS-V, delivering a stunning 650 hp and 650 lb.-ft. of torque. Each component of the rotating assembly, from the crankshaft to the piston rings, is unique to the LT4 and necessary to support the boosted engine's cylinder pressure. The LT4 produces 9.4 psi of intake boost with a 1.7L supercharger.

L8T 6.6L

The power behind the Silverado HD, the 6.6L L8T is our largest displacement LT engine. Direct injected for precise fuel control. The L8T is built for strength with a cast iron, long-skirt block with six-bolt cross bolted mains and a forged steel crankshaft offering 401 horsepower and 464 lb-ft of torque. It shares the same basic LT bore with a longer stroke 4.065 x 3.860 (103.25mm x 98mm).

L8P 6.6L

Chevrolet's LT crate engine family grew in 2024 with the L8P performance engine. The L8P blends the strength and displacement of the L8T 6.6L production-based engine with a unique non-AFM LT2 based camshaft and additional enhancements to offer 523 horsepower and 543 lb-ft of torque. The L8P shares the same bore and stroke as the L8T 4.065 x 3.860 (103.25mm x 98mm).

Gen V Small-Block Engines

RPO Code	Displacement (cu/in/Liters)	Compression Ratio	Horsepower	Torque (lb.-ft.)
LT1	376 / 6.2	11.5:1	460 @ 6,000 rpm	465 @ 4,600 rpm
LT4	376 / 6.2	10.0:1	650 @ 6,400 rpm	650 @ 3,600 rpm
LT5	376 / 6.2	10.0:1	755 @ 6,400 rpm	715 @ 3,600 rpm
L8T	400/6.6	10.8:1	401 @ 5200 rpm	464 @ 4000 rpm
L8P	400/6.6	10.8:1	523 @ 5800 rpm	543 @ 4600 rpm

LS-SERIES POWER UPGRADES

Give Your LS3-Based Engine a Performance Boost!

These easy, factory-tested upgrades can breathe new life into your old LS3 or LS376/480 Crate Engine.

Your LS3 Crate Engine is already a powerful, legendary performance package. But if you're looking to add a little more "get-up-and-go" without breaking the bank, your Chevrolet Performance team of engineers have the answer: a choice of two validated Power Upgrades that can take your existing crate engine to new levels of performance.

Using proven Chevrolet Performance engine components, these two upgrade packages can take one of our most versatile LS-Series crate engines and add up to 95 horsepower and more than 60 additional lb.-ft. of torque. In addition, these upgrades have been extensively tested and validated, so you are assured of factory-backed performance unavailable in the aftermarket.

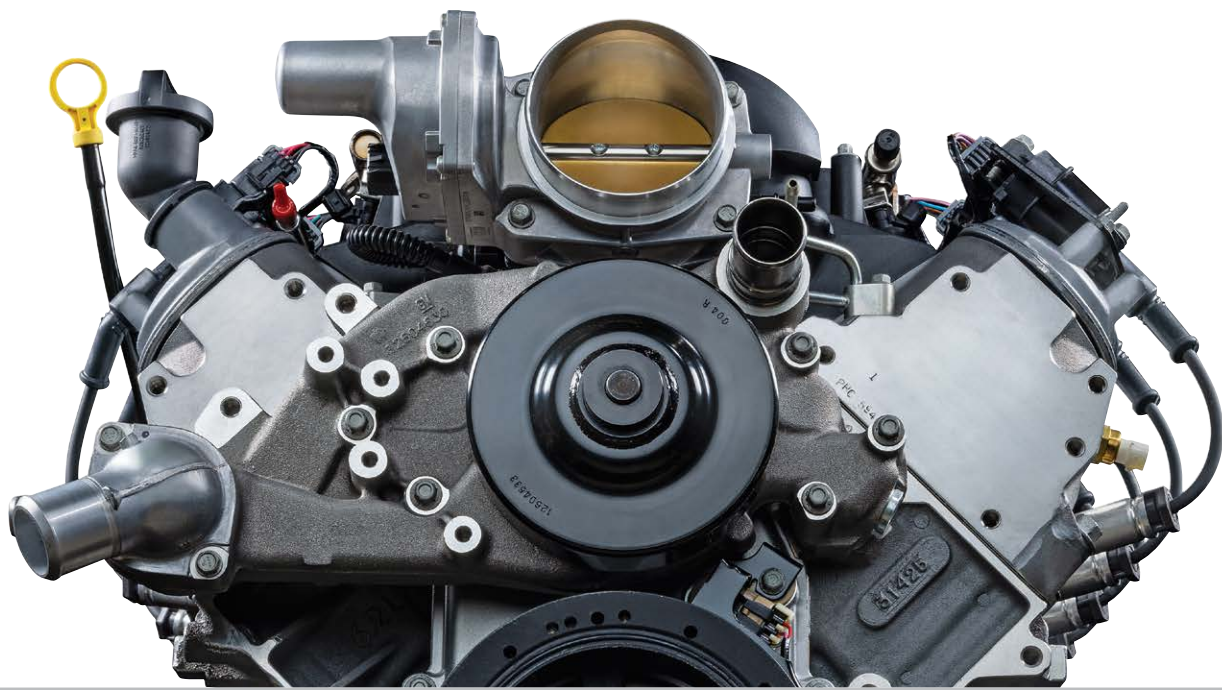

LS3

430 hp

425 lb.-ft.

LS376/480

495 hp

473 lb.-ft.

LS376/525

525 hp

486 lb.-ft.

 Chevrolet Performance Crate Engines include a 24-month or 50,000-mile/80,000-kilometer limited warranty, whichever comes first. See your GM dealer for details.

 Chevrolet Performance Parts include a 12-month/unlimited mile limited warranty.

 This part is intended for competition use only. See page 2 for complete details.

LS3 Crate Engine 430 HP 425 LB.-FT.

HP:	430 @ 5,900 rpm
Torque:	425 lb.-ft. @ 4,600 rpm
Camshaft Duration:	204° int. / 211° exh.
Valve Lift:	.551 int. / .522 exh.

Destined to go down in history as one of Chevrolet's most versatile performance engines, the 430-hp LS3 6.2L offers a fantastic combination of modern technology.

Filled with components designed for high performance and longevity, the LS3 features a sturdy reciprocating assembly matched with L92-type rectangular port heads and a high-lift, hydraulic roller camshaft. It optimizes the LS3's tremendous airflow and supports a broad torque curve.

Designed for easy conversion, each of the two Power Upgrades incorporate genuine Chevrolet Performance parts – all designed and tested for exact fit and demanding performance!

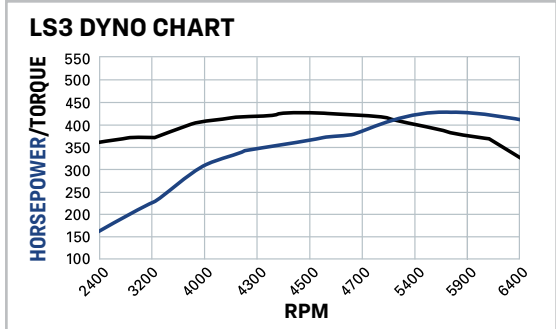

LS3 CRATE ENGINE COMPONENTS:

LS Camshaft.....	12623063
Camshaft Gear.....	12591689
Camshaft Gear Bolt.....	11561283
Engine Controller.....	19354329

LS Hot Cam Upgrade +65 HP +48 LB.-FT.

HP:	495 hp @ 6,200 rpm
Torque	473 lb.-ft. @ 5,000 rpm
Camshaft Duration:	219° int. / 228° exh.
Valve Lift:	.525 int. / .525 exh.

This Hot Cam adds real heat to the LS3!

Swap the stock LS3 camshaft for the racing-inspired LS Hot Cam and you get a LS376/480 with a stunning 495 horsepower and 473 lb.-ft. of torque! That's nearly 14 percent more power and torque from just a camshaft change!

The key to the power boost is the Hot Cam's 0.525-inch lift on both the intake and exhaust sides, along with 219-degree/228-degree duration specs. This allows the valves to stay open a little longer to draw in more air from the rectangular-port L92-style heads.

Adding a 3-bolt camshaft gear and new electronic control unit (ECU) completes the upgrade.

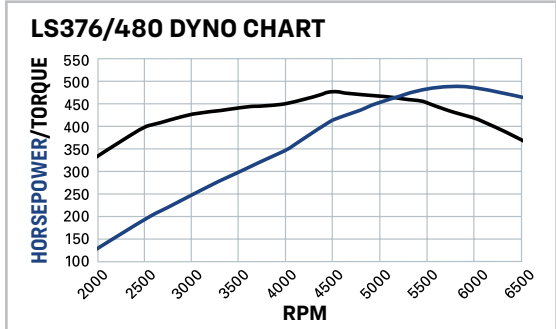

LS HOT CAM UPGRADE COMPONENTS:

LS Hot Cam.....	88958753
Camshaft Gear.....	12623754*
Camshaft Gear Bolt (x3).....	11588723*
Engine Controller.....	19354331

ASA Cam Upgrade +95 HP** +61 LB.-FT.**

HP:	525 hp @ 6,200 rpm
Torque	486 lb.-ft. @ 5,200 rpm
Camshaft Duration:	226° int. / 236° exh.
Valve Lift:	.525 int. / .525 exh.

A Bigger Cam for Bigger Performance!

Turn your LS3 (or LS376/480) into a LS376/525, one of Chevrolet Performance's most powerful naturally aspirated 6.2L engines! The ASA Camshaft expands the performance range, especially at high rpm, providing an impressive 525 horsepower and 486 lb.-ft. of torque!

The camshafts 226 degree duration on the intake side and 236 degrees on the exhaust side, coupled with a tight 110-degree lobe separation angle, helps deliver excellent throttle response and breathability at high rpm.

A 3-bolt camshaft gear* and new electronic control unit (ECU) are required to finish the upgrade.

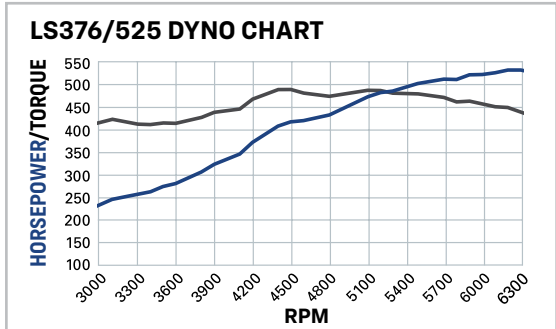

ASA CAM UPGRADE COMPONENTS:

ASA Camshaft.....	88958770
Camshaft Gear.....	12623754*
Camshaft Gear Bolt (x3).....	11588723*
Engine Controller.....	19354333

*The LS3 crate engine utilizes a one-bolt camshaft gear while the LS376/480 and the LS376/525 have a 3-bolt camshaft gear, so upgrading from the LS3 to either of the two Power Upgrades will require replacement of the camshaft gear and bolts. Upgrading from the LS376/480 to the LS376/525 does not require replacement of the camshaft gear and bolts.

**Power increases were calculated using the 430 hp LS3 Crate Engine as the baseline. Upgrading from the LS376/480 to the LS376/525 will result in increases of 30 horsepower and 17 lb.-ft. of torque.

LS3

19540155 
430 hp

@ 5,900 rpm

425 lb.-ft.

@ 4,600 rpm

DYNO CHART

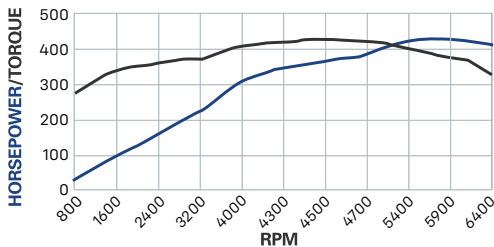

NOTE: Refer to page 6 for the complete horsepower and torque testing procedures.



A contemporary classic

Destined to go down in history as one of Chevrolet's most versatile performance engines, the 430-hp LS3 6.2L offers a fantastic combination of modern technology.

The LS3 is filled with components designed for high performance and longevity, starting with a sturdy reciprocating assembly that's matched with L92-type rectangular-port heads and a high-lift, hydraulic roller camshaft. It all optimizes the LS3's tremendous airflow and supports a broad torque curve.

Our LS3 crate engine comes complete, from the Camaro F-body oil pan to the ignition system. It also includes the intake manifold assembly with injectors and throttle body, water pump, balancer and 58X reluctor wheel. The Camaro F-body oil pan may not suit all installation applications. Use a vehicle-specific oil pan for original LS-powered vehicles or Chevrolet Performance's Muscle Car Oil Pan Kit P/N 19212593 for older vehicles.

INSTALLATION NOTES

- Assembly does not include any electronics
- Use LS3 Controller Kit P/N 19354328 for engine operation. Kit includes electronic throttle pedal, which is required for throttle input to the ECU (see page 115)
- Includes Camaro F-body oil pan
- Not intended for marine applications
- Front-End Accessory Drive Kits are available in several configurations (see page 104 for application)
- Does not include exhaust manifolds or flexplate/flywheel

Mobil 1 is the recommended engine oil for all Chevrolet Performance Engines

TECH SPECS

Part Number:	19540155
Engine Type:	LS-Series Gen IV Small-Block V-8
Displacement (cu in):	376 (6.2L)
Bore x Stroke (in):	4.065 x 3.622 (103.25 x 92mm)
Block (P/N 12729604):	Cast aluminum with 6-bolt, cross-bolted main caps
Crankshaft (P/N 12736808):	Nodular iron
Connecting Rods (P/N 12649190):	Powdered metal
Pistons (P/N 19207287):	Hypereutectic aluminum
Camshaft Type (P/N 12623063):	Hydraulic roller
Valve Lift (in):	.551 intake / .522 exhaust
Camshaft Duration (@.050 in):	204° intake / 211° exhaust
Cylinder Heads (P/N 12675871):	Aluminum L92-style port; as-cast with 68cc chambers
Valve Size (in):	2.165 intake / 1.590 exhaust
Compression Ratio:	10.7:1
Rocker Arms (P/N 12696105 int):	Investment-cast, roller trunnion
Rocker Arms (P/N 12681275 exh):	Investment-cast, roller trunnion
Rocker Arm Ratio:	1.7:1
Recommended Fuel:	Premium pump
Maximum Recommended rpm:	6,600
Reluctor Wheel:	58x
Balanced:	Internal



Chevrolet Performance Crate Engines include a 24-month or 50,000-mile/80,000-kilometer limited warranty, whichever comes first. See your GM dealer for details.



Chevrolet Performance does not utilize any used or remanufactured parts in this crate engine, except for the starter, alternator and power steering pump.



This part is intended for competition use only. See page 2 for complete details.

ADDITIONAL BUILD OPTIONS

19435106 

LS3 Long Block

LS long-blocks from Chevrolet Performance offer the core capabilities of complete crate engines at a lower cost, allowing builders to finish the assembly their way. The LS3 long block is delivered without the intake manifold, coil packs, water pump, exhaust manifolds or other accessories.







CONNECT & CRUISE CONFIGURATIONS

Chevrolet Performance's Connect & Cruise systems match our crate engines with transmissions for factory-tailored performance combinations—including supporting controllers and installation kit recommendations—that take the guesswork out of your project. See page 32 for more details.



LS3 Automatic Connect & Cruise Systems

Connect & Cruise System	Engine	Engine Controller	Transmission	Installation Kit	Torque Converter	Trans. Controller
LS3 6.2L 2WD with 4L65-E	19540155 	19354328	19368611	19259117	19299802	19302405
LS3 6.2L 2WD with 4L70-E	19540155 	19354328	19368613	19259117	19299802	19302405
LS3 6.2L 4WD with 4L70-E	19540155 	19354328	19368612	19259117	19299802	19302405
LS3 6.2L 2WD with 6L80-E	19540155 	19354328	19417102 or 19366637	19420358	<i>included with trans.</i>	<i>included with trans.</i>
LS3 6.2L 4WD with 6L80-E	19540155 	19354328	19432680 or 19432790	19420358	<i>included with trans.</i>	<i>included with trans.</i>

LS3 Manual Connect & Cruise Systems

Connect & Cruise System	Engine	Engine Controller	Transmission	Installation Kit
LS3 6.2L with Super Magnum 6-Speed	19540155 	19354328	19352208	19301625

TRANSMISSION OPTIONS

See pages 20–31 for additional options.



19368611
SuperMatic™ 4L65-E Four-Speed Automatic (remanufactured) *page 24*



19366637
SuperMatic™ 6L80-E Six-Speed Automatic *page 26*



19352208
Super Magnum Six-Speed Manual *page 29*

ENGINE-RELATED PARTS & ACCESSORIES



19299802
SuperMatic™ Torque Converter
page 22



19302405
Transmission Controller
page 28



19329620
LS/LT Bell Housing
page 29



Parts intended for competition use only. See page 2 for details.



LS364/450

19434650 

452 hp

@5,600rpm

441 lb.-ft.

@ 4,800 rpm

DYNO CHART

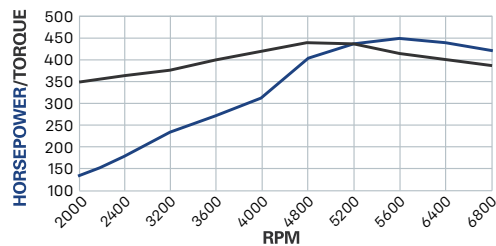

NOTE: Refer to page 6 for the complete horsepower and torque testing procedures.

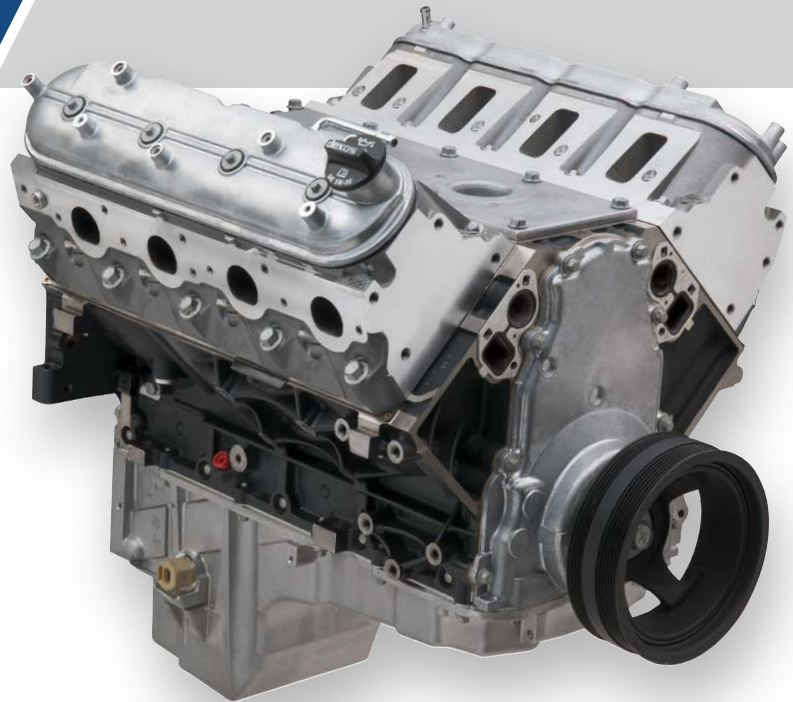

The budget performer of the LS family!

Chevrolet Performance engineers have developed the LS364/450 6.0L as a value-driven foundation for builders and enthusiasts looking to give their earlier LS-powered vehicles a high-performance shot in the arm.

Starting with a strong, economical iron cylinder block and durable rotating assembly, it features the high-lift LS6 camshaft and deep-breathing LS3 aluminum cylinder heads. It's a strong combination that provides exceptional horsepower and a broad torque band. It is also fuel injection-capable, using production-based components offered in this catalog. Additionally, the LS364/450 is designed with the early-style 24X crankshaft and 1X camshaft sensors, enabling easy retro-fit installation in early LS-powered vehicles.

We offer the LS364/450 exclusively as a long-block assembly, without the induction system, ignition system or front-end accessory drive system, allowing builders to transfer components from their early LS-powered vehicle or complete a custom build with the components of their choice. An intake manifold that matches the LS3/L92-style rectangular intake ports is required.

INSTALLATION NOTES

- Assembly does not include any electronics
- Engine is compatible with a vehicle's existing Gen III controller, but tuning is required
- Includes LQ9 oil pan
- Requires intake manifold matched to LS3- or L92-style rectangular intake ports
- LS3 or L96 production intake manifolds can be used, but require an aftermarket adapter plate for use with early LS three-bolt throttle bodies
- Not intended for marine applications

Mobil 1 is the recommended engine oil for all Chevrolet Performance Engines

TECH SPECS

Part Number:	19434650
Engine Type:	Performance LQ9 long block
Displacement (cu in):	364 cu in (6.0L)
Bore x Stroke (in):	4.000 x 3.622 in (101.6 x 92 mm)
Block:	Cast iron with 6-bolt block, cross-bolted main caps
Crankshaft:	Nodular iron
Connecting Rods:	Powdered metal
Pistons:	Hypereutectic aluminum
Camshaft Type (P/N 12565308):	LS6 hydraulic roller
Valve Lift (in):	0.550 intake / 0.550 exhaust
Camshaft Duration (@.050 in):	204° intake / 218° exhaust
Cylinder Heads:	LS3 rectangular port; aluminum, as-cast with 68cc chambers
Valve Size (in):	2.165 intake (hollow stem) 1.590 exhaust (solid stem)
Compression Ratio:	10.3:1 (nominal)
Rocker Arms:	Investment-cast, roller bearing trunnion
Rocker Arm Ratio:	1.7:1
Recommended Fuel:	Premium pump
Maximum Recommended rpm:	6,800
Reluctor Wheel:	24Xe
Balanced:	Internal



Chevrolet Performance Crate Engines include a 24-month or 50,000-mile/80,000-kilometer limited warranty, whichever comes first. See your GM dealer for details.



Chevrolet Performance does not utilize any used or remanufactured parts in this crate engine, except for the starter, alternator and power steering pump.



This part is intended for competition use only. See page 2 for complete details.

TRANSMISSION OPTIONS

See pages 20–31 for additional options.

19368613**SuperMatic™ 4L70-E Four-Speed Automatic** (remanufactured)

Based on the 4L60-E, the 4L70-E electronically controlled four-speed automatic is rated for up to 495 lb.-ft. of torque. For strength, it features five-pinion gearsets, heat-treated stator shaft splines, an induction-hardened turbine shaft and more, including a unique valve body calibration. Does not include converter. See page 24 for more details.

**19352208****Super Magnum Six-Speed Manual**

This high-torque capacity TREMEC six-speed manual is designed for custom, retro-fit installations with Chevrolet Performance crate engines. It has a 700-lb.-ft. torque capacity and features a 40-tooth reluctor ring that's necessary for use with the electronic vehicle speed sensors used with Chevrolet Performance controllers. See page 29 for more details.



ENGINE-RELATED PARTS & ACCESSORIES

19540154 
**LS3 Intake Manifold
Assembly**

page 109

19301246 
**Air Inlet Kit for
LS-Based Crate Engine
Installation**

page 109

19212593
**Muscle Car Oil
Pan Kit**

page 109

19299802
**SuperMatic™
Torque Converter**

page 22

19302405
**Transmission
Controller**

page 28

19329620
LS/LT Bell Housing Kit

page 29

19301625
**Transmission
Installation kit**
*Includes factory-style
F-car bell housing*

page 29

19331080
**Transmission
Installation Kit**
*Includes Super Magnum
steel bell housing*

page 30



Parts intended for competition use only.
See page 2 for details.



Performance

55

LS376/480

19540156 

495 hp

473 lb.-ft.

@ 6,200 rpm

@ 5,000 rpm

DYNO CHART

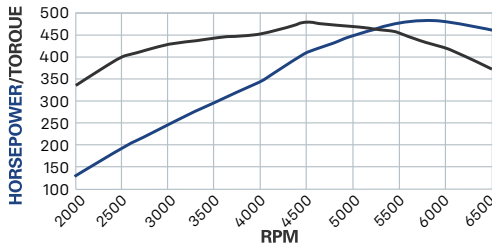

NOTE: Refer to page 6 for the complete horsepower and torque testing procedures.



The Hot Cam adds heat to the LS3

When our engineers took a production LS3 6.2L (376 cubic inches) engine and swapped the stock camshaft for the racing-inspired LS Hot Cam (P/N 88958753), the result was a stunning 495 horsepower and 473 lb.-ft. of torque. That's nearly 14 percent more power and torque from just a camshaft change!

We wasted no time in adding that terrific combination—dubbed LS376/480—to our crate engine portfolio. The key to the power boost is the Hot Cam's 0.525-in lift on both the intake and exhaust sides, along with 219-degree/228-degree duration specs. That's less lift on the intake side than the stock LS3 cam, but considerably more duration, allowing the valves to stay open a little longer to draw in more air from the rectangular-port L92-style heads.

The crate engine package includes the intake manifold, throttle body and fuel rails, along with the ignition system. Use it with the LS376/480 controller kit P/N 19354330.

INSTALLATION NOTES

- Assembly does not include any electronics
- Use LS376/480 Controller Kit P/N 19354330 for engine operation. Kit includes electronic throttle pedal, which is required for throttle input to the ECU (see page 115)
- Includes Camaro F-body wet sump oil pan
- Not intended for marine applications
- Front-End Accessory Drive Kits are available in two configurations (see page 104 for application)
- Does not include exhaust manifolds or flexplate/flywheel

Mobil 1 is the recommended engine oil for all Chevrolet Performance Engines

TECH SPECS

Part Number:	19540156
Engine Type:	LS-Series Gen IV Small-Block V-8
Displacement (cu in):	376 (6.2L)
Bore x Stroke (in):	4.065 x 3.622 (103.25 x 92mm)
Block (P/N 12729604):	Cast aluminum with 6-bolt, cross-bolted main caps
Crankshaft (P/N 12736808):	Nodular iron
Connecting Rods (P/N 12649190):	Powdered metal
Pistons (P/N 19207287):	Hypereutectic aluminum
Camshaft Type (P/N 88958753):	Hydraulic roller
Valve Lift (in):	.525 intake / .525 exhaust
Camshaft Duration (@.050 in):	219° intake / 228° exhaust
Cylinder Heads (P/N 12675871):	Aluminum L92-style port; as-cast with 68cc chambers
Valve Size (in):	2.165 intake/ 1.590 exhaust
Compression Ratio:	10.7:1
Rocker Arms (P/N 12696105 int):	Investment-cast, roller trunnion
Rocker Arms (P/N 12681275 exh):	Investment-cast, roller trunnion
Rocker Arm Ratio:	1.7:1
Recommended Fuel:	Premium pump
Maximum Recommended rpm:	6,600
Reluctor Wheel:	58x
Balanced:	Internal



Chevrolet Performance Crate Engines include a 24-month or 50,000-mile/80,000-kilometer limited warranty, whichever comes first. See your GM dealer for details.



Chevrolet Performance does not utilize any used or remanufactured parts in this crate engine, except for the starter, alternator and power steering pump.



This part is intended for competition use only. See page 2 for complete details.

ADDITIONAL BUILD OPTIONS

19435108 

LS376/480 Long Block

LS long-blocks from Chevrolet Performance offer the core capabilities of complete crate engines at a low cost, allowing builders to finish the assembly their way. The LS376/480 long block is delivered without the intake manifold, coil packs, water pump, exhaust manifolds or other accessories.



CONNECT & CRUISE CONFIGURATIONS

Chevrolet Performance's Connect & Cruise systems match our crate engines with transmissions for factory-tailored performance combinations—including supporting controllers and installation kit recommendations—that take the guesswork out of your project. See page 32 for more details.

LS376/480 with 4L70-E Automatic Transmission 

Engine:	19540156	Install Kit:	19259117
Engine Controller:	19354330	Torque Converter:	19299803
Transmission:	19368613	Trans. Controller:	19302405



LS376/480 with 6L80-E Automatic Transmission 

Engine:	19540156	Install Kit:	19420358
Engine Controller:	19354330	Torque Converter:	<i>included w/ Trans.</i>
Transmission:	19417102 or 19366637	Trans. Controller:	<i>included w/ Trans.</i>

LS376/480 with Super Magnum Six-Speed Manual 

Engine:	19540156	Transmission:	19352208
Engine Controller:	19354330	Install Kit:	19301625

TRANSMISSION OPTIONS

See pages 20–31 for additional options.



19368613
SuperMatic™ 4L70-E Four-Speed Automatic (remanufactured)

page 24



19366637 or 19417102
SuperMatic™ 6L80-E Six-Speed Automatic

page 26



19352208
Super Magnum Six-Speed Manual

page 29

ENGINE-RELATED PARTS & ACCESSORIES



19354330 
LS376/480 Controller Kit
page 115



19302405
Transmission Controller
page 28



19212593
Muscle Car Oil Pan Kit
page 109



19299803
SuperMatic™ Torque Converter
page 22



19421444
Corvette Accessory Drive Kit
page 104



19301246 
Air Inlet Kit for LS-Based Crate Engine Installation
page 109



Parts intended for competition use only. See page 2 for details.



Performance

LS376/515

19435102 

533 hp

@ 6,600 rpm

477 lb.-ft.

@ 5,200 rpm

DYNO CHART

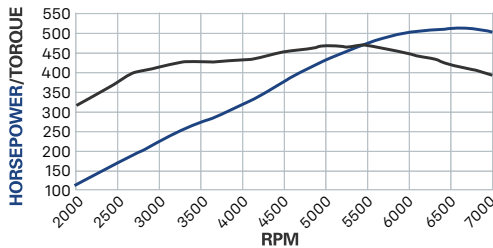

NOTE: Refer to page 6 for the complete horsepower and torque testing procedures.

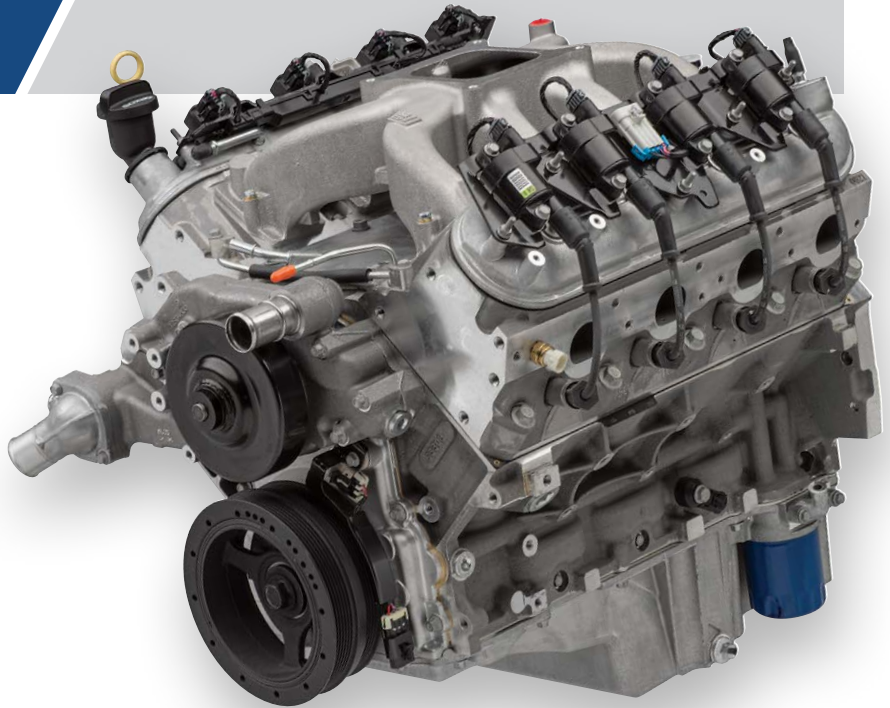

Big LS power designed for carburetors

With the proven LS3 engine as its foundation, the LS376/515 crate engine matches the racing-derived ASA Hot Cam and a carbureted induction system to produce 533 horsepower at a stellar 6,600 rpm and 477 lb.-ft. of torque at 5,200 rpm.

The assembly includes an SS oil pan and LS3 cylinder heads, with high-flow, rectangular-port intake passages, as well as our unique, spider-type carburetor intake manifold. At the heart of the engine is the ASA Hot Cam, which extends the performance range of the LS3 with more duration. That means it holds the valves open longer, enabling greater airflow at higher rpm.

You'll need our LSX controller P/N 19355418 and Holley 770-cfm carburetor P/N 19420445 to complete the engine and get it running. And if you're installing it in an older vehicle, use our Muscle Car Oil Pan Kit P/N 19212593.

INSTALLATION NOTES

- Assembly does not include any electronics
- Use LS/LSX Ignition Controller P/N 19355418 (includes harness) (see page 113)
- Includes Camaro F-body wet sump oil pan
- Not intended for marine applications
- Holley 770-cfm Carburetor P/N 19420445 recommended
- Front-End Accessory Drive Kits are available in two configurations (see page 104 for application)
- Does not include exhaust manifolds or flexplate/flywheel

Mobil 1 is the recommended engine oil for all Chevrolet Performance Engines

TECH SPECS

Part Number:	19435102
Engine Type:	LS-Series Gen IV Small-Block V-8
Displacement (cu in):	376 (6.2L)
Bore x Stroke (in):	4.065 x 3.622 (103.25 x 92mm)
Block (P/N 12729604):	Cast aluminum with 6-bolt, cross-bolted main caps
Crankshaft (P/N 12736808):	Nodular iron
Connecting Rods (P/N 12649190):	Powdered metal
Pistons (P/N 19207287):	Hypereutectic aluminum
Camshaft Type (P/N 88958770):	Hydraulic roller
Valve Lift (in):	.525 intake / .525 exhaust
Camshaft Duration (@.050 in):	226° intake / 236° exhaust
Cylinder Heads (P/N 12675871):	Aluminum L92-style port; as-cast with 68cc chambers
Valve Size (in):	2.165 intake / 1.590 exhaust
Compression Ratio:	10.7:1
Rocker Arms (P/N 12696105 int):	Investment-cast, roller trunnion
Rocker Arms (P/N 12681275 exh):	Investment-cast, roller trunnion
Rocker Arm Ratio:	1.7:1
Recommended Fuel:	Premium pump
Maximum Recommended rpm:	6,600
Reluctor Wheel:	58x
Balanced:	Internal



Chevrolet Performance Crate Engines include a 24-month or 50,000-mile/80,000-kilometer limited warranty, whichever comes first. See your GM dealer for details.



Chevrolet Performance does not utilize any used or remanufactured parts in this crate engine, except for the starter, alternator and power steering pump.



This part is intended for competition use only. See page 2 for complete details.

ADDITIONAL BUILD OPTIONS

19435110 

LS376/525 Long Block

LS long-blocks from Chevrolet Performance offer the core capabilities of complete crate engines at a low cost, allowing builders to finish the assembly their way. The LS376/525 long block is delivered without the intake manifold, coil packs, water pump, exhaust manifolds or other accessories.

NOTE: LS376/525 Long Block is used to build LS376/515 crate engine



CONNECT & CRUISE CONFIGURATIONS

Chevrolet Performance's Connect & Cruise systems match our crate engines with transmissions for factory-tailored performance combinations—including supporting controllers and installation kit recommendations—that take the guesswork out of your project. See page 32 for more details.

LS376/515 with 4L70-E Automatic Transmission 

Engine:	19435102	Torque Converter:	19299803
Transmission:	19368613	Trans. Controller:	19332775
Install Kit:	19259117		

LS376/515 with Super Magnum Six-Speed Manual 

Engine:	19435102	Install Kit:	19301625
Transmission:	19352208		

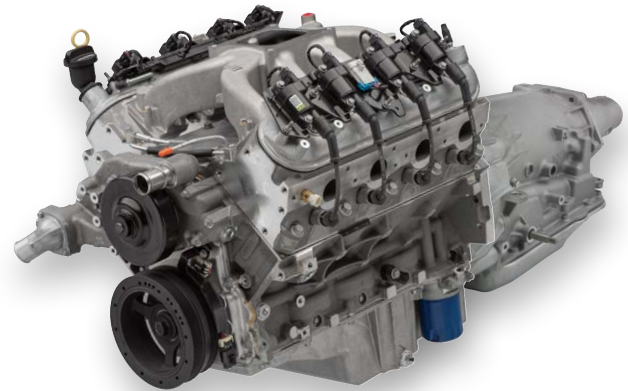

TRANSMISSION OPTIONS

See pages 20–31 for additional options.

**19368613
SuperMatic™ 4L70-E
Four-Speed Automatic
(remanufactured)**

Based on the 4L60-E, the 4L70-E electronically controlled four-speed automatic is rated for up to 495 lb.-ft. of torque. For strength, it features five-pinion gearsets, heat-treated stator shaft splines, an induction-hardened turbine shaft and more. See page 24 for more details.



**19352208
Super Magnum
Six-Speed Manual**

This high-torque capacity TREMEC six-speed manual is designed for custom, retro-fit installations with Chevrolet Performance crate engines. It has a 700-lb.-ft. torque capacity and features a 40-tooth reluctor ring. See page 29 for more details.



ENGINE-RELATED PARTS & ACCESSORIES



**19332775
Transmission
Controller**
page 28



19355418 
**LS/LSX Ignition
Controller**
page 113



**19212593
Muscle Car
Oil Pan Kit**
page 109



**19299803
SuperMatic™
Torque Converter**
page 22



**19421444
Corvette
Accessory
Drive Kit**
page 104



19420445 
**Carburetor –
Holley 770-cfm**
page 112



Parts intended for competition use only. See page 2 for details.



Performance

LS376/525

19540157 

525 hp

@ 6,200 rpm

486 lb.-ft.

@ 5,200 rpm

DYNO CHART

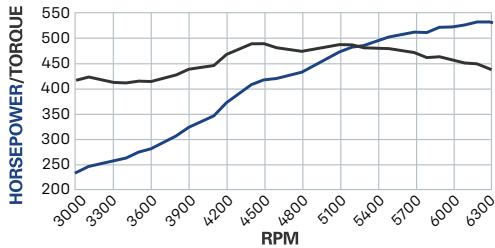

NOTE: Refer to page 6 for the complete horsepower and torque testing procedures.



A bigger cam for great performance!

Chevrolet Performance's LS376/525 is one of our most powerful naturally aspirated 6.2L crate engines. It's based on the LS3, but adds our aggressive ASA camshaft to expand the performance range, particularly at high rpm, resulting in 525 horsepower and 486 lb.-ft. of torque.

The ASA camshaft is a hydraulic roller with .525-inch lift on both sides, along with 226 degrees duration on the intake side and 236 degrees on the exhaust side. Coupled with a tight 110-degree lobe separation angle, it helps the engine deliver excellent throttle response and breath exceptionally well at high rpm.

You'll need tuning to make the most of the engine in a late-model GM vehicle. If you plan to use the LS376/525 in a vintage car, you'll need the controller kit P/N 19354332, which includes the throttle pedal to match its electronically controlled throttle body. Use our Muscle Car Oil Pan Kit P/N 19212593 for installation in older vehicles.

INSTALLATION NOTES

- Assembly does not include any electronics
- Use LS376/525 Engine Controller Kit for engine operation, P/N 19354332 (see page 115)
- Includes Camaro F-body wet sump oil pan
- Not intended for marine applications
- Front-End Accessory Drive Kits are available in several configurations (see page 104 for application)
- Does not include exhaust manifolds or flexplate/flywheel

Mobil 1 is the recommended engine oil for all Chevrolet Performance Engines

TECH SPECS

Part Number:	19540157
Engine Type:	LS-Series Gen IV Small-Block V-8
Displacement (cu in):	376 (6.2L)
Bore x Stroke (in):	4.065 x 3.622 (103.25 x 92mm)
Block (P/N 12729604):	Cast aluminum with 6-bolt, cross-bolted main caps
Crankshaft (P/N 12736808):	Nodular iron
Connecting Rods (P/N 12649190):	Powdered metal
Pistons (P/N 19207287):	Hypereutectic aluminum
Camshaft Type (P/N 88958770):	Hydraulic roller
Valve Lift (in):	.525 intake / .525 exhaust
Camshaft Duration (@.050 in):	226° intake / 236° exhaust
Cylinder Heads (P/N 12675871):	Aluminum L92-style port; as-cast with 68cc chambers
Valve Size (in):	2.165 intake / 1.590 exhaust
Compression Ratio:	10.7:1
Rocker Arms (P/N 12669995 int):	Investment-cast, roller trunnion
Rocker Arms (P/N 12681275 exh):	Investment-cast, roller trunnion
Rocker Arm Ratio:	1.7:1
Recommended Fuel:	Premium pump
Maximum Recommended rpm:	6,600
Reluctor Wheel:	58x
Balanced:	Internal



Chevrolet Performance Crate Engines include a 24-month or 50,000-mile/80,000-kilometer limited warranty, whichever comes first. See your GM dealer for details.



Chevrolet Performance does not utilize any used or remanufactured parts in this crate engine, except for the starter, alternator and power steering pump.



This part is intended for competition use only. See page 2 for complete details.

ADDITIONAL BUILD OPTIONS

19435110 

LS376/525 Long Block

LS long-blocks from Chevrolet Performance offer the core capabilities of complete crate engines at a low cost, allowing builders to finish the assembly their way. The LS376/525 long block is delivered without the intake manifold, coil packs, water pump, exhaust manifolds or other accessories.



CONNECT & CRUISE CONFIGURATIONS

Chevrolet Performance's Connect & Cruise systems match our crate engines with transmissions for factory-tailored performance combinations—including supporting controllers and installation kit recommendations—that take the guesswork out of your project. See page 32 for more details.



LS376/525 with 4L70-E Automatic Transmission 

Engine:	19540157	Install Kit:	19259117
Engine Controller:	19354332	Torque Converter:	19299803
Transmission:	19368613	Trans. Controller:	19302405

LS376/525 with 6L80-E Automatic Transmission 

Engine:	19540157	Install Kit:	19420358
Engine Controller:	19354332	Torque Converter:	<i>included w/ Trans.</i>
Transmission:	19366637 or 19417102	Trans. Controller:	<i>included w/ Trans.</i>

LS376/525 with 4L75-E Automatic Transmission 

Engine:	19540157	Install Kit:	19259117
Engine Controller:	19354332	Torque Converter:	19299803
Transmission:	19368615	Trans. Controller:	19302405

LS376/525 with Super Magnum Six-Speed Manual 

Engine:	19540157	Transmission:	19352208
Engine Controller:	19354332	Install Kit:	19301625

TRANSMISSION OPTIONS

See pages 20–31 for additional options.



19368613
SuperMatic™ 4L70-E Four-Speed Automatic (remanufactured)

page 24



19366637 or 19417102
SuperMatic™ 6L80-E Six-Speed Automatic

page 26



19352208
Super Magnum Six-Speed Manual

page 29

ENGINE-RELATED PARTS & ACCESSORIES



19354332 
LS376/525 Controller Kit
 page 115



19302405
Transmission Controller
 page 28



19212593
Muscle Car Oil Pan Kit
 page 109



19299803
SuperMatic™ Torque Converter
 page 22



19421444
Corvette Accessory Drive Kit
 page 104



19301246 
Air Inlet Kit for LS-Based Crate Engine Installation
 page 109



Parts intended for competition use only. See page 2 for details.



Performance

DR525

19434599  with Gen 4 F-Car Oil Pan (shown)

525 hp

@ 6,200 rpm

498 lb.-ft.

@ 4,400 rpm

19434600  with Muscle Car Oil Pan (not shown)

525 hp

@ 6,200 rpm

494 lb.-ft.

@ 4,400 rpm

NOTE: Refer to page 6 for the complete horsepower and torque testing procedures.

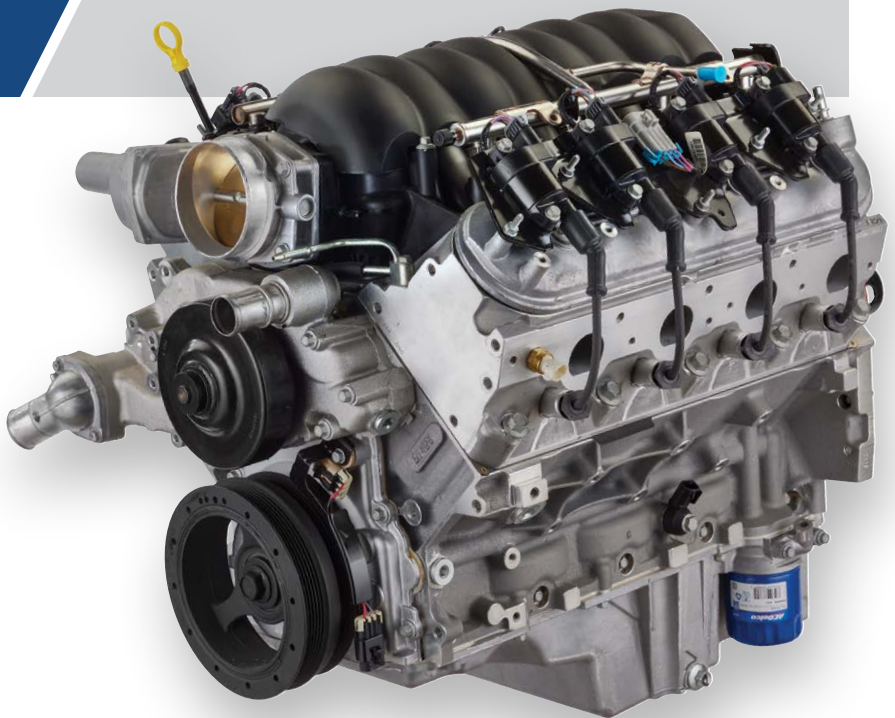

Big power for the drag strip!

Chevrolet Performance's DR525 sealed drag racing crate helps enable exciting heads-up racing at a lower cost than custom-built engines. It's an approach Chevrolet Performance implemented in a number of circle track racing series, providing racers with a high-performance engine at a great value.

The DR525 is designed as the spec engine for NMCA's LS Stock racing class in the LSX Showdown Challenge Series. The 6.2L (376 cubic inches) naturally aspirated engine is rated at 525 horsepower and features several tamper-proof bolts to ensure class compliance. And while it is the spec engine for the LS Stock class, the DR525 is legal in other classes and drag racing series.

It is offered with two part numbers: 19434600 (includes Chevrolet Performance's Muscle Car Oil Pan) and 19434599 (includes a Gen 4 F-body oil pan). Chevrolet Performance's custom-calibrated E67-type control system - P/N 19432870 (sold separately, must use C10 fuel only)—must be used with the DR525 in the LS Stock class. It features a tamper-proof engine control unit.

INSTALLATION NOTES

- Assembly does not include any electronics
- Use DR525 Engine Controller Kit for engine operation, P/N 19432870 (see page 115)
- Not intended for marine applications
- Front-End Accessory Drive Kit, P/N 19329418, not included with engine assembly (see page 105)
- Must use C10 fuel only

Mobil 1 is the recommended engine oil for all Chevrolet Performance Engines

TECH SPECS

Part Number:	19434600 (w/Muscle Car Oil Pan) 19434599 (w/Gen 4 F-Car Oil Pan)
Engine Type:	LS-Series Gen IV Small-Block V-8
Displacement (cu in):	376 (6.2L)
Bore x Stroke (in):	4.065 x 3.622 (103.25 x 92mm)
Block (P/N 12729604):	Cast aluminum with 6-bolt, cross-bolted main caps
Crankshaft (P/N 12736808):	Nodular iron
Connecting Rods (P/N 12649190):	Powdered metal
Pistons (P/N 19207287):	Hypereutectic aluminum
Camshaft Type (P/N 88958770):	Hydraulic roller
Valve Lift (in):	.525 intake / .525 exhaust
Camshaft Duration (@.050 in):	226° intake / 236° exhaust
Cylinder Heads (P/N 12675871):	Aluminum L92-style port; as-cast with 68cc chambers
Valve Size (in):	2.165 intake / 1.590 exhaust
Compression Ratio:	10.7:1
Rocker Arms (P/N 12669995 int):	Investment-cast, roller trunnion
Rocker Arms (P/N 12681275 exh):	Investment-cast, roller trunnion
Rocker Arm Ratio:	1.7:1
Recommended Fuel:	Premium pump
Maximum Recommended rpm:	6,600
Reluctor Wheel:	58x
Balanced:	Internal



This Chevrolet Performance Racing Crate Engine is purpose-built for racing only, and has no warranty.



Chevrolet Performance does not utilize any used or remanufactured parts in this crate engine, except for the starter, alternator and power steering pump.



This part is intended for competition use only. See page 2 for complete details.

TRANSMISSION OPTIONS

See pages 20–31 for additional options.

19368615

SuperMatic™ 4L75-E Four-Speed Automatic Transmission (remanufactured)

Based on the 4L65-E/4L70-E, the 4L75-E electronically controlled four-speed automatic is rated for up to 650 lb.-ft. of torque. For strength, it features five-pinion gearsets, heat-treated stator shaft splines, an induction-hardened turbine shaft and more, including a unique valve body calibration. Does not include converter. See page 24 for more details.

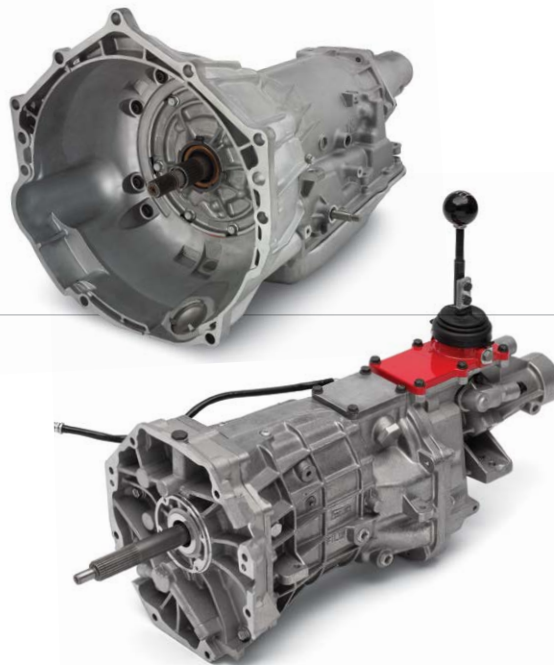

19352208

Super Magnum Six-Speed Manual

This high-torque capacity TREMEC six-speed manual is designed for custom, retro-fit installations with Chevrolet Performance crate engines. It has a 700-lb.-ft. torque capacity and features a 40-tooth reluctor ring that's necessary for use with the electronic vehicle speed sensors used with Chevrolet Performance controllers. See page 29 for more details.

ENGINE-RELATED PARTS & ACCESSORIES



19354340 ⚡

DR525 Controller and Harness

19432870 ⚡

DR525 C10 Fuel Controller and Harness

page 115

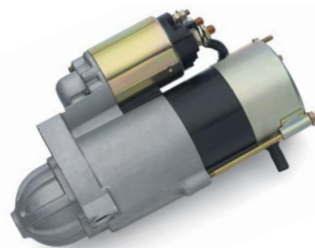

10465385 ⚡

LS-Series Starter (remanufactured)

page 111



19301246 ⚡

Air Inlet Kit for LS-Based Crate Engine Installation

page 109

OEM SEALED FOR NMCA COMPETITION



Engines are factory-sealed with tamper resistant seals to maintain engine integrity when used in NMCA drag racing class competition. Seals are engine specific and are designed for single-time use.



Parts intended for competition use only. See page 2 for details.



Performance

LS9 Long Block

12624262 

638 hp

@ 6,500 rpm*

604 lb.-ft.

@ 3,800 rpm*

*With production supercharger system not included.



NOTE: Refer to page 6 for the complete horsepower and torque testing procedures.

A factory foundation for boost

As the foundation for the supercharged engine that powered the 2009-13 Corvette ZR1, our LS9 is a long block built for boost—delivered without the supercharger or front-end accessory drive system, allowing the builder to finish the engine with the power adder of his or her choice. It is rated for 12 lbs. of boost.

The assembly includes a forged rotating assembly (including lightweight titanium connecting rods), rotocast aluminum cylinder heads with titanium intake valves and stainless hollow exhaust valves, multiple engine sensors and six ignition coils. It also includes a dry-sump oil pan, which requires the builder to add an external oil tank.

Whether you use a supercharger or turbo system, the LS9 long block is the assembled foundation developed for the boost you want to make. It made the C6 ZR1 a legend in its own time—and there's no telling where its performance potential will take your project!

INSTALLATION NOTES

- Assembly does not include any electronics
- Includes dry-sump oil pan and requires external oil tank (not included). Oil pan change required for wet-sump oiling
- Includes 9-bolt crankshaft flange that may require adapter for use with some transmissions
- Induction system and front-end accessory drive system not included
- Not intended for marine applications

Mobil 1 is the recommended engine oil for all Chevrolet Performance Engines

TECH SPECS

Part Number:	12624262
Engine Type:	LS-Series Gen-IV Small-Block V-8
Displacement (cu. in.):	376 (6.2L)
Bore x Stroke (in.):	4.065 x 3.622 (103.25 x 92 mm)
Block:	Cast-aluminum with six-bolt, cross-bolted main caps
Crankshaft (P/N 12641693):	Forged steel with nine-bolt flange
Connecting Rods (P/N 12624231):	Forged titanium
Pistons (P/N 19180414):	Forged aluminum
Camshaft Type (P/N 12638427):	Hydraulic roller
Valve Lift (in.):	.562 intake / .558 exhaust
Camshaft Duration (@.050 in.):	211° intake / 230° exhaust
Cylinder Heads (P/N 12621774):	Aluminum L92-style ports; "as cast" with 68-cc chambers
Valve Size (in.):	2.160 titanium intake / 1.590; hollow, sodium-filled exhaust
Compression Ratio:	9:1:1
Rocker Arms (P/N 12696105 int):	Investment-cast, roller trunnion
Rocker Arms (P/N 12681275 exh):	Investment-cast, roller trunnion
Rocker Arm Ratio:	1.7:1
Recommended Fuel:	Premium pump
Maximum Recommended rpm:	6600
Reluctor Wheel:	58X
Balanced:	Internal



Chevrolet Performance Crate Engines include a 24-month or 50,000-mile/80,000-kilometer limited warranty, whichever comes first. See your GM dealer for details.



Chevrolet Performance does not utilize any used or remanufactured parts in this crate engine, except for the starter, alternator and power steering pump.



This part is intended for competition use only. See page 2 for complete details.

Building boost with the LS9 Long Block

Chevrolet Performance engineers top 1,000 hp¹ with twin-turbo test engine²

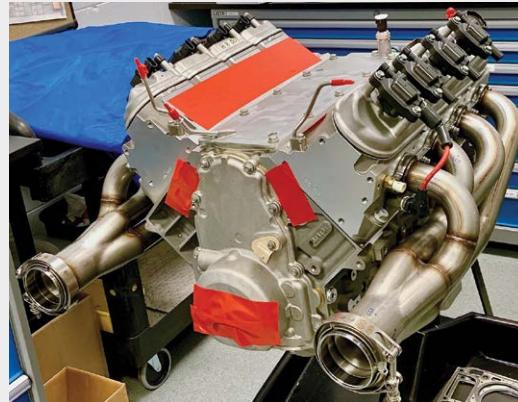
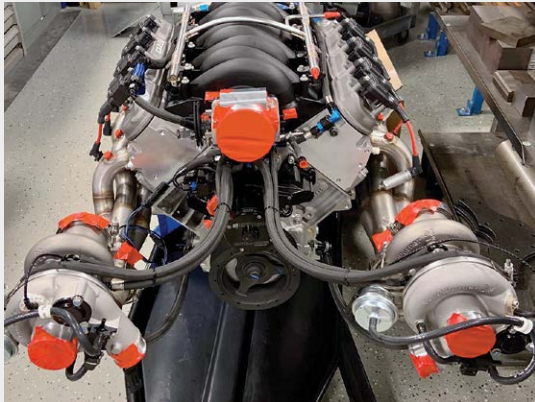

Left: This is what 1,000 turbocharged horsepower looks like with an LS9 long block, an LS3 intake manifold, twin turbos and an E85 fuel system.

Right: The LS9 long block has forged internals, a 9:1:1 compression ratio and robust head gaskets, all designed for boost.

Our all-new LS9 Long Block assembly (P/N 12624262) was originally designed to support the supercharged performance in the C6 Corvette ZR1. It has tough, all-forged internals and other components designed to support the boosted platform.

Chevrolet Performance offers the LS9 Long Block as a strong base for custom boosted engine builds, so our engineers took one and built a test engine to probe its capabilities. Specifically, they wanted to know if the LS9 Long Block could support 1,000 force-induced horsepower.

Spoiler alert: It did.

With the completely stock long block, the engineers added a production LS3 intake manifold assembly (including throttle body and injectors), a pair of turbochargers and stainless steel 1-7/8-inch turbo headers. Engine management was handled by a custom control system.

Some quick calculations determined the stock LS3 fuel injectors wouldn't be able to support the fuel requirements for the capability of the twin-turbo system, so they were replaced with higher-flow injectors. The engine was also tuned for E85 fuel, while the turbos were kept under max boost until the upper range of the rpm band, peaking at 18 psi.

The result was an amazing 1,020 horsepower and 990 lb.-ft. of torque on a dyno at the GM Racing and Performance Center in Pontiac, Michigan. It was all with a stock LS9 long block, a production intake manifold and off-the-shelf fuel system and turbo components.

"It's an incredible result, but one builders can easily replicate with the LS9 long block and similar components," said engineer Vince Tiaga. "The LS9 is a strong foundation for boosted engines and that's what we set out to prove."

Importantly, the engineering team kept pushing the engine, making a number of follow-up dyno pulls to confirm not only the combination's capability, but its durability. The testing included a number of simulated drag-racing pulls, as well as follow-up tests that pushed the engine even further.

"The bottom line is we never stop testing our engines and parts," said Tiaga. "The LS9 long block passed with flying colors—and the tests proved it's comparatively easy to make big power with it!"

IMPORTANT NOTE: The results of this test were achieved by professional engineers with state-of-the-art diagnostic equipment in a controlled environment. This exercise was conducted to illustrate that higher-than-production horsepower and torque levels can be achieved with aftermarket power-adders and alternative fuels. Chevrolet Performance does not guarantee the performance of the LS9 long-block beyond the original production engine, as critical elements such as spark control, air-fuel ratio, fuel type and quality are beyond our control.

¹Data achieved via pulls on dyno that were all 1000hp +/- 1.5%.

²Because of their effect on a vehicle's emissions performance, these engines are intended exclusively for use in competition vehicles. These engines are designed and intended for use in vehicles operated exclusively for competition: in racing or organized competition on courses separate from public streets or highways. Installation or use of these engines on a vehicle operated on public streets or highways is likely to violate U.S., Canadian, and state and provincial laws and regulations related to motor vehicle emissions.

Results achieved using our LS3 Intake Manifold Assembly

19540154 🛠️

See page 109 for product details



Check out the full, three-part story at theBlock.com



Project LS9TT Part One:
The Components



Project LS9TT Part Two:
The Dyno



Project LS9TT Part Three:
The Upgrades



Parts intended for competition use only.
See page 2 for details.



Performance

65



SMALL-BLOCK

LT-Series Crate Engines

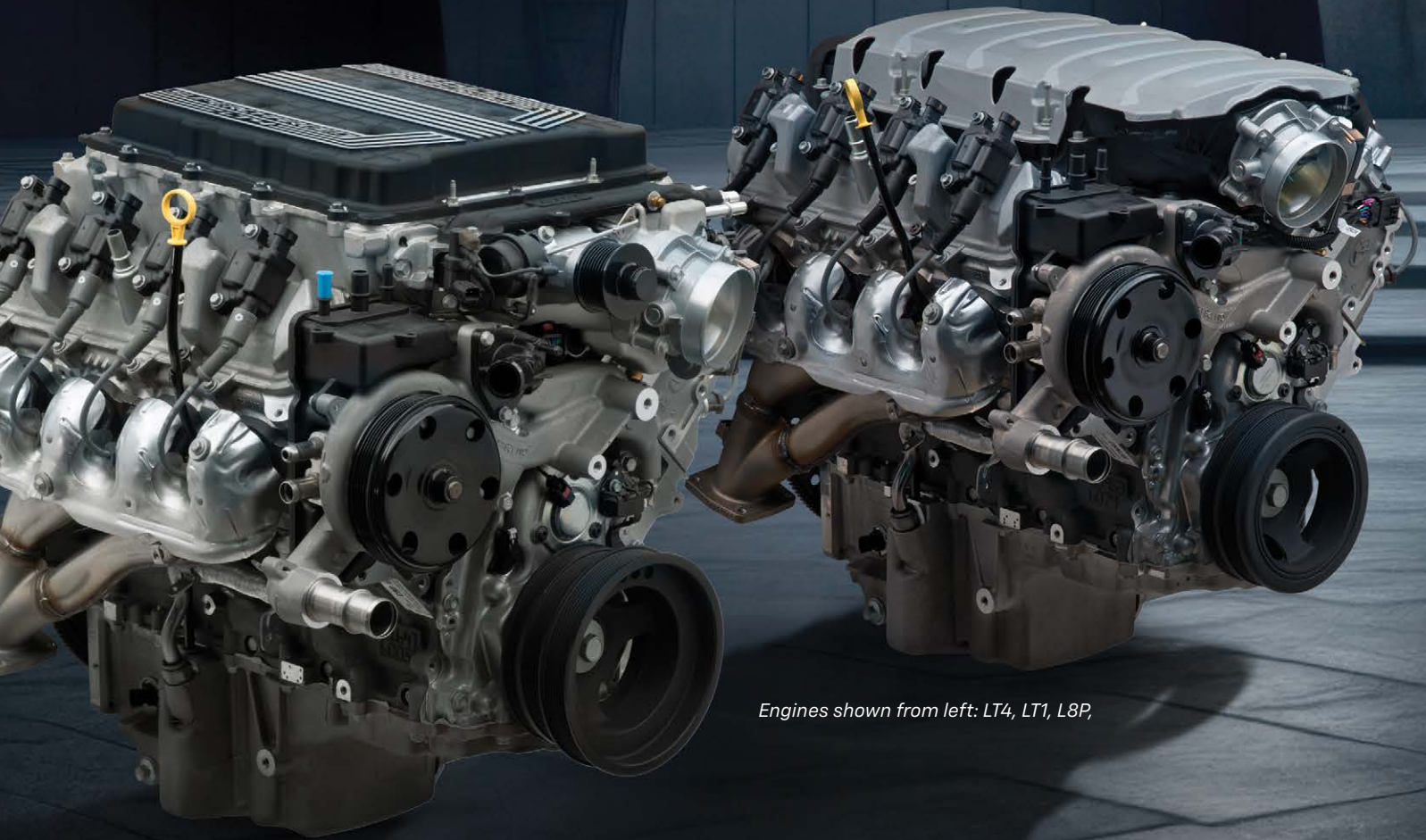

Engines shown from left: LT4, LT1, L8P,

The latest performance technology from Chevrolet

Chevrolet's LT engine family builds on decades of V-8 engineering prowess to take performance technology to the next level, with features such as direct injection and variable valve timing that contribute to strong output and great capability. Our LT portfolio includes the high-revving, Camaro SS-based LT1, the supercharged LT4 that powered the Gen 6 Camaro ZL1, the big-torque L8T 6.6L engine and, of course, the L8P performance crate engine, which blends the strength and displacement of the L8T 6.6L production-based engine with a Corvette-based camshaft and additional enhancements to offer 523 horsepower and 543lb.-ft. of torque. It's all the latest performance technology from Chevrolet!

Check out the following pages to find the Chevrolet Performance LT-Series Engine that's right for you!

LT1.....	68	L8T.....	72
LT4.....	70	L8P.....	74

NOTE: Engine may not come with all the parts shown in photo. See your dealer for more details.



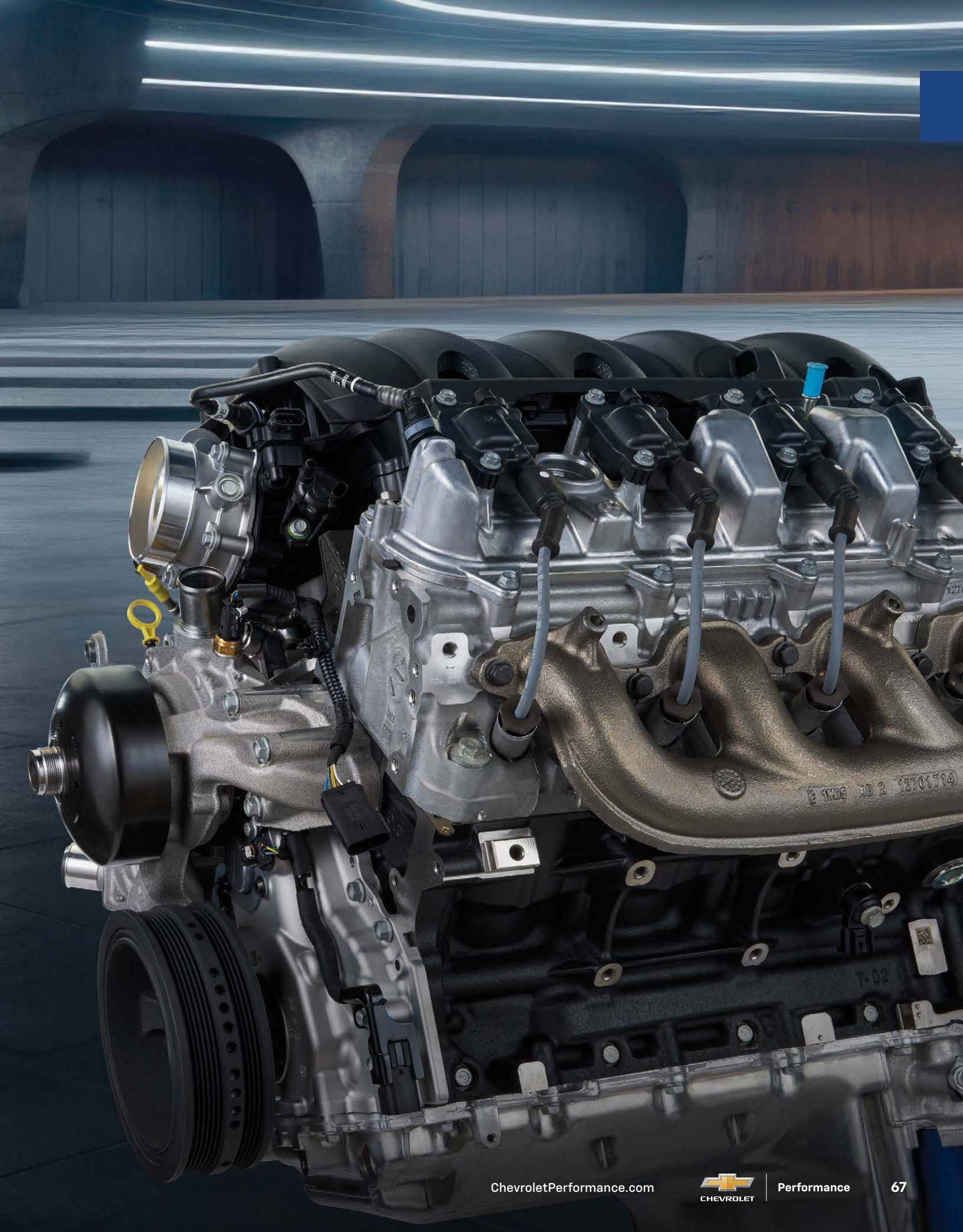

LT1

19431953 

455 hp

@ 6,000 rpm

455 lb.-ft.

@ 4,400 rpm

DYNO CHART

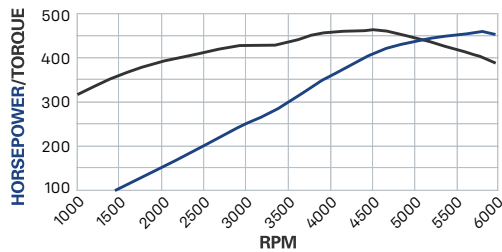

NOTE: Refer to page 6 for the complete horsepower and torque testing procedures.

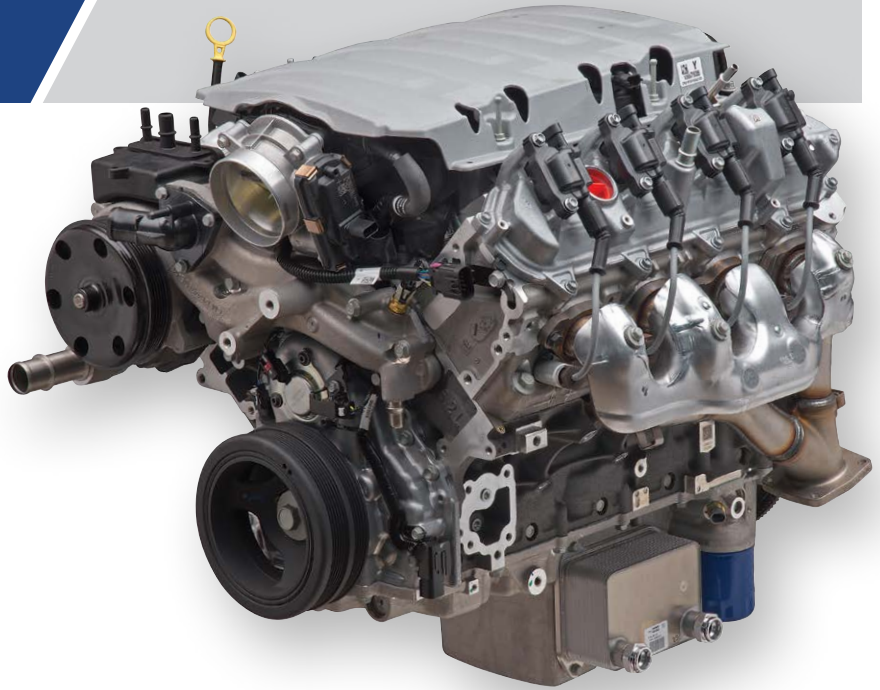

NOTE: Includes oil cooler line and oil tube/cap assembly (not shown in photo).

Fifth Generation Chevrolet Performance

The LT1 6.2L opened the next chapter in the historic legacy of the Small-Block engine—and it gives your project vehicle a high-tech heart transplant with a balance of performance and efficiency. Our crate engine is rated at 455 horsepower and 455 lb.-ft. of torque.

The LT1 is architecturally similar to the LS family of Small-Block engines, but with a unique block casting, cylinder head design, oiling system and more. It also combines advanced technologies, including direct injection and continuously variable valve timing. See page 115 for the recommended controller.

INSTALLATION NOTES

- Engines shipped with high-pressure direct-injection fuel pump installed
- Assembly does not include any electronics
- Select the right controller kit for your LT1 Engine (see chart on page 115)
- Not intended for marine applications
- Front-End Accessory Drive system must be ordered separately (see page 106)
- Use P/N 19417547 Front-End Accessory Drive system without air conditioning and P/N 19369182 A/C add-on kit (see page 106)
- Can accommodate P/N 19420208 Hydraulic Power Steering Kit (not included with Accessory Drive System, see page 106)
- Includes 8-bolt flexplate
- Chevrolet Performance control kits do not use the Active Fuel Management components on this crate engine

Mobil 1 is the recommended engine oil for all Chevrolet Performance Engines

TECH SPECS

Part Numbers:	19431953
Engine Type:	Direct injection spark ignition Gen V Small-Block V-8
Displacement (cu in):	376 (6.2L)
Bore x Stroke (in):	4.065 x 3.622 (103.25 x 92mm)
Block (P/N 12718007):	Cast aluminum with 6-bolt nodular iron main bearing caps
Crankshaft (P/N 12710954):	Forged steel
Connecting Rods (P/N 12669756):	Forged powdered metal
Pistons (P/N 12664891-L, 12664890-R):	Hypereutectic aluminum
Camshaft Type (P/N 12629512):	Billet steel roller
Valve Lift (in):	0.550 intake / 0.522 exhaust
Camshaft Duration (@0.050 in):	200° intake / 206° exhaust
Cylinder Heads (P/N 12699617):	Aluminum, rectangular port D/I
Valve Size (in):	2.130 intake / 1.590 exhaust
Compression Ratio:	11.5:1
Rocker Arms (P/N 12619829):	Investment-cast, roller bearing trunnion
Rocker Arm Ratio:	1.81:1
Recommended Fuel:	Premium pump
Maximum Recommended rpm:	6,600
Reluctor Wheel:	58x
Balanced:	Internal



Chevrolet Performance Crate Engines include a 24-month or 50,000-mile/80,000-kilometer limited warranty, whichever comes first. See your GM dealer for details.



Chevrolet Performance **does not** utilize any used or remanufactured parts in this crate engine, except for the starter, alternator and power steering pump.



This part is intended for competition use only. See page 2 for complete details.

TRANSMISSION OPTIONS

See pages 20–31 for additional options.



19368614
SuperMatic™ 4L70-E
Four-Speed Automatic
(remanufactured)
page 24



19432682 or 19432684
SuperMatic™ 6L80-E
Six-Speed Automatic
(remanufactured)
page 26



19419798
SuperMatic™ 8L90-E
Eight-Speed Automatic
page 27



19436466
SuperMatic™ 10L90-E
Ten-Speed Automatic
page 28



19352208
Super Magnum
Six-Speed Manual
page 29

CONNECT & CRUISE CONFIGURATIONS

Chevrolet Performance's Connect & Cruise systems match our crate engines with transmissions for factory-tailored performance combinations—including supporting controllers and installation kit recommendations—that take the guesswork out of your project. See page 32 for more details.



LT1 6.2L Automatic Connect & Cruise Systems

Connect & Cruise System	Engine	Engine Controller	Transmission	Installation Kit	Torque Converter	Transmission Controller
LT1 6.2L with 4L70-E	19431953	19433246	19368614	19329416	19299802	19302405
LT1 6.2L E-ROD with 4L70-E	19433063	<i>included with E-ROD kit</i>	19368614	19329416	19299802	19302405
LT1 6.2L with 6L80-E	19431953	19433601	19432682 or 19432684	19435470	<i>included with trans.</i>	<i>included with trans.</i>
LT1 6.2L E-ROD with 6L80-E	19433869	<i>included with E-ROD kit</i>	19432682 or 19432684	19435470	<i>included with trans.</i>	<i>included with trans.</i>
LT1 6.2L with 8L90-E	19431953	19433247	19419798	19417103	<i>included with trans.</i>	<i>included with trans.</i>
LT1 6.2L E-ROD with 8L90-E	19433059	<i>included with E-ROD kit</i>	19419798	19417103	<i>included with trans.</i>	<i>included with trans.</i>
LT1 6.2L with 10L90-E	19431953	19433247	19436466	19420810	<i>included with trans.</i>	<i>included with trans.</i>
LT1 6.2L E-ROD with 10L90-E	19433059	<i>included with E-ROD kit</i>	19436466	19420810	<i>included with trans.</i>	<i>included with trans.</i>

LT1 6.2L Manual Connect & Cruise Systems

Connect & Cruise System	Engine	Engine Controller	Transmission	Installation Kit
LT1 6.2L with Super Magnum 6-Speed	19431953	19433246	19352208	19329912
LT1 6.2L E-ROD with Super Magnum 6-Speed	19433063	<i>included with E-ROD kit</i>	19352208	19329912

E-ROD LT1 6.2L SYSTEMS

19433063 w/4L Automatic and 6-Speed Manual

19433869 w/6L Automatic

19433059 w/8L and 10L Automatic

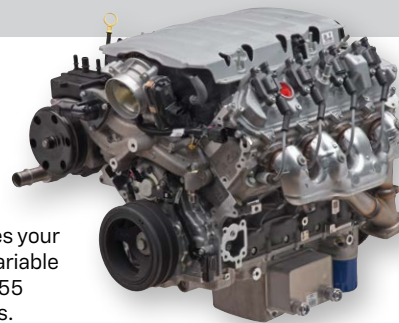

CARB E0#: D-126-54

The LT1 6.2L expands the legacy of the Small-Block engine and gives your project vehicle a high-tech heart transplant with direct injection, variable valve timing and more. Our 50-state-legal package is rated at 455 horsepower and 455 lb.-ft. of torque. See page 78 for more details.

IMPORTANT NOTE: Do not use pre-2022 LT1 and LT4 Engine Controllers with 2022 LT1 and LT4 crate engines. Correct applications are listed below.

2022 LT1 Engine/Controller Compatibility Chart

Engine Description	Model Year	Engine P/N	Fuel Pressure Sensor	Transmission Type	Controller kit P/N
LT1	2022-	19431953	3 Pin	4L or 6-Speed Manual	19433246
LT1	2022-	19431953	3 Pin	6L	19433601
LT1	2022-	19431953	3 Pin	8L and 10L	19433247



NOTE: Controller Kits for pre-2022 LT1 engines are also available. See page 115.

See page 115 for details.



This part is 50 state emissions street legal when installed and used as described in the CARB executive order. See page 2 for details



Parts intended for competition use only. See page 2 for details.



Performance

LT4

19431955 

650 hp

@ 6,400 rpm

650 lb.-ft.

@ 3,600 rpm

DYNO CHART

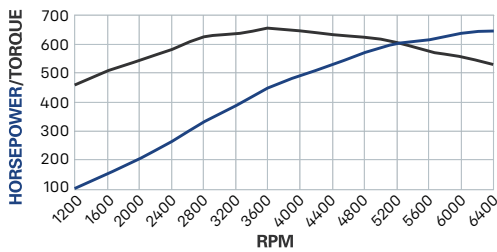

NOTE: Refer to page 6 for the complete horsepower and torque testing procedures.



NOTE: Includes oil cooler line and oil tube/cap assembly (not shown in photo).

Also Includes LSA/LS9 Intercooler Fluid Pump P/N 13597903.

Supercharged Power from the C7 Corvette Z06!

At the time of its release, the supercharged LT4 6.2 SC was the most powerful engine ever offered in a regular production Chevrolet, and was the heart of the Camaro ZL1. It features a compact, efficient 1.7L Eaton R1740 TVS supercharger, which spins at up to 20,000 rpm. That's enough to generate more than 9 pounds of boost and help produce 650 horsepower and 650 lb.-ft. of torque.

The LT4 is based on the same Gen V Small-Block architecture as the LT1 engine, with several unique features designed to support its higher output and the greater cylinder pressures created by forced induction. They include Rotocast A356T6 aluminum cylinder heads, which are stronger and handle heat better than conventional castings, lightweight titanium intake valves and stronger forged aluminum pistons.

INSTALLATION NOTES

- Assembly does not include any electronics
- Select the right controller kit for your LT4 engine (see chart on page 115)
- Front-End Accessory Drive system must be ordered separately (see page 106)
- Can accommodate P/N 19420210 Hydraulic Power Steering Kit (not included with Accessory Drive System, see page 107)
- Includes 8-bolt flexplate
- Not intended for marine applications
- Crankshaft has 8-bolt flywheel mounting pattern
- Engine includes direct injection and VVT
- Chevrolet Performance control kits do not use the Active Fuel Management components on this crate engine

Mobil 1 is the recommended engine oil for all Chevrolet Performance Engines

TECH SPECS

Part Number:	19431955
Engine Type:	Gen V Small-Block V-8
Displacement (cu in):	376 (6.2L)
Bore x Stroke (in):	4.065 x 3.622 (103.25 x 92mm)
Block (P/N 12718007):	Cast aluminum with 6-bolt, cross-bolted main caps
Crankshaft (P/N 12712984):	Forged steel
Connecting Rods (P/N 12719127):	Forged powdered-metal steel
Pistons (P/N 12733421-L, 12733420-R):	Forged aluminum
Camshaft Type (P/N 12642245):	Hydraulic roller
Valve Lift (in):	.502 intake / .561 exhaust
Camshaft Duration (@.050 in):	188° intake / 223° exhaust
Cylinder Heads (P/N 12699619):	A356T6 Rotocast aluminum; as cast with 65.5cc chambers
Valve Size (in):	2.130 intake / 1.590 exhaust
Compression Ratio:	10:1
Rocker Arms (P/N 12619829):	Investment-cast, roller bearing trunnion
Rocker Arm Ratio:	1.81:1
Recommended Fuel:	Premium pump
Maximum Recommended rpm:	6,600
Reluctor Wheel:	58x
Balanced:	Internal



Chevrolet Performance Crate Engines include a 24-month or 50,000-mile/80,000-kilometer limited warranty, whichever comes first. See your GM dealer for details.



Chevrolet Performance does not utilize any used or remanufactured parts in this crate engine, except for the starter, alternator and power steering pump.



This part is intended for competition use only. See page 2 for complete details.

TRANSMISSION OPTIONS

See pages 20–31 for additional options.



19368615
SuperMatic™ 4L75-E
Four-Speed Automatic
(remanufactured)
page 24



19432682 or 19432684
SuperMatic™ 6L80-E
Six-Speed Automatic
(remanufactured)
page 26



19419799
SuperMatic™ 8L90-E
Eight-Speed Automatic
page 27



19436467
SuperMatic™ 10L90-E
Ten-Speed Automatic
page 28



19352208
Super Magnum
Six-Speed Manual
page 29

CONNECT & CRUISE CONFIGURATIONS

Chevrolet Performance's Connect & Cruise systems match our crate engines with transmissions for factory-tailored performance combinations—including supporting controllers and installation kit recommendations—that take the guesswork out of your project. See page 32 for more details.



LT4 6.2L SC Automatic Connect & Cruise Systems

Connect & Cruise System	Engine	Engine Controller	Installation Kit	Transmission	Torque Converter	Transmission Controller
LT4 6.2L with 4L75-E	19431955	19433248	19329416 + 1912581 ¹	19368615	19299802	19302405
LT4 6.2L E-ROD with 4L75-E	19433071	<i>included with E-ROD kit</i>	19329416 + 1912581 ¹	19368615	19299802	19302405
LT4 6.2L with 6L80-E	19431955	19433632	19435470	19432682 or 19432684	<i>included with trans.</i>	<i>included with trans.</i>
LT4 6.2L E-ROD with 6L80-E	19433872	<i>included with E-ROD kit</i>	19435470	19432682 or 19432684	<i>included with E-ROD kit</i>	<i>included with trans.</i>
LT4 6.2L with w/8L90-E	19431955	19433249	19417103	19419799	<i>included with trans.</i>	<i>included with trans.</i>
LT4 6.2L E-ROD w/8L90-E	19433067	<i>included with E-ROD kit</i>	19417103	19419799	<i>included with E-ROD kit</i>	<i>included with trans.</i>
LT4 6.2L SC w/10L90-E	19431955	19433249	19420810	19436467	<i>included with trans.</i>	<i>included with trans.</i>
LT4 6.2L E-ROD w/10L90-E	19433067	<i>included with E-ROD kit</i>	19420810	19436467	<i>included with E-ROD kit</i>	<i>included with trans.</i>

¹Bell Housing Kit

LT4 6.2L SC Manual Connect & Cruise Systems

Connect & Cruise System	Engine	Engine Controller	Installation Kit	Transmission
LT4 6.2L with Super Magnum 6-Speed	19431955	19433248	19329912	19352208
LT4 6.2L E-ROD with Super Magnum 6-Speed	19433071	<i>included with E-ROD kit</i>	19329912	19352208

E-ROD LT4 6.2L SC SYSTEMS

- 19433071** w/4L Automatic and 6-Speed Manual
- 19433872** w/6L Automatic
- 19433067** w/8L and 10L Automatic



CARB EO#: D-126-55

The LT4 6.2L is our most powerful, emissions-compliant E-ROD crate engine package, with 650 horsepower and 650 lb.-ft. of torque—all driven by an Eaton TVS supercharger. See page 79 for more details.



IMPORTANT NOTE: Do not use pre-2022 LT1 and LT4 Engine Controllers with 2022 LT1 and LT4 crate engines. Correct applications are listed below.

2022 LT4 Engine/Controller Compatibility Chart

Engine Description	Model Year	Engine P/N	Fuel Pressure Sensor	Transmission Type	Controller kit P/N
LT4	2022–	19431955	3 Pin	4L or 6-Speed Manual	19433248
LT4	2022–	19431955	3 Pin	6L	19433632
LT4	2022–	19431955	3 Pin	8L and 10L	19433249



NOTE: Controller Kits for pre-2022 LT4 engines are also available. See page 115.

See page 115 for details.



This part is 50 state emissions street legal when installed and used as described in the CARB executive order. See page 2 for details



Parts intended for competition use only. See page 2 for details.



Performance

L8T

19435733  (2024+)

401 hp

@ 5,200 rpm

464 lb.-ft.

@ 4,000 rpm

DYNO CHART

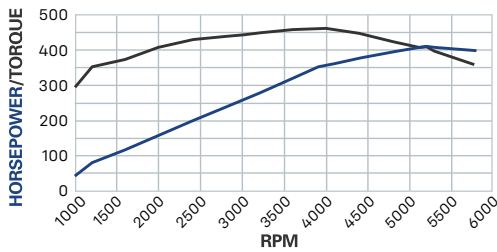

NOTE: Refer to page 6 for the complete horsepower and torque testing procedures.



Heavy-Duty Power from Chevy's HD Trucks

With 401 horsepower and 464 lb.-ft. of torque on tap, the L8T crate engine is the largest-displacement LT-family engine in our lineup, offering plenty of low-rpm torque. Direct injection offers more precise fuel control than port injection, enabling a comparatively high compression ratio of 10.8:1 in the engine, which contributes to its high output.

It's built with a forged steel crankshaft and other high-strength parts. Additional features such as oil-spray cooling for the pistons and a cast iron, long-skirt cylinder block with six-bolt, cross-bolted main caps contribute to the engine's strength and durability. Comes with production style exhaust manifolds.

Our L8T crate engine package comes complete from the throttle body to the oil pan, including the PCV tube, evap tube, oil dipstick and oil fill tube and cap. It does not include the controller, harness, oxygen sensors or a Front End Accessory Drive system. See Installation Notes below for recommendations.

INSTALLATION NOTES

- Engine is shipped with high-pressure direct-injection fuel pump installed
- Front End Accessory Drive system must be ordered separately and includes hydraulic power steering, with center pulley. Pulley-mounted fan not recommended. See page 107 for options.
- Includes 8-bolt flexplate for automatic transmissions
- 2024+ use with Engine Control kit 19435726 for 6L80-E transmission. Use Engine Control kit 19435606 for 10L90-E transmission. See page 115 for details.
- Available in Connect & Cruise with 6L80 and 10L90 transmission options

Mobil 1 is the recommended engine oil for all Chevrolet Performance Engines

TECH SPECS

Part Number:	19435733 (2024+)
Engine Type:	Gen V Small Block V-8 direct injection spark ignition
Displacement (cu in):	400 (6.6L)
Bore x Stroke (in / mm):	4.065 x 3.860 (103.25 mm x 98 mm)
Block (P/N 19420904):	Cast iron with 6-bolt nodular main bearing caps
Crankshaft (P/N 12708884):	Forged steel
Connecting Rods (P/N 12675746):	Forged powder-metal
Pistons (P/N 12699527-R, 12699529-L):	Hypereutectic aluminum
Camshaft Type (P/N 12672469):	Billet steel hydraulic roller
Valve Lift (in):	0.500 intake / 0.492 exhaust
Camshaft Duration (@ 0.050 in):	193° intake / 199° exhaust
Cylinder Heads (P/N 12703610):	Aluminum rectangular port D/I with 59.02cc chambers
Valve Size (in):	2.130 hollow intake / 1.590 inconel exhaust
Compression Ratio:	10.8:1
Rocker Arms (P/N 12619829):	Investment cast roller trunnion
Rocker Arm Ratio:	1.8:1
Intake manifold (P/N 12639087):	Composite
Throttle body (P/N 12730580):	87mm diameter (single-bore)
Fuel delivery:	High-pressure direct injection (2,175 psi / 150 bar)
Recommended Fuel:	87 octane
Ignition system:	Coil-on-plug
Maximum Recommended RPM:	5600 rpm
Reluctor wheel:	58X
Balanced:	Internal

 Chevrolet Performance Crate Engines include a 24-month or 50,000-mile/80,000-kilometer limited warranty, whichever comes first. See your GM dealer for details.

 Chevrolet Performance does not utilize any used or remanufactured parts in this crate engine, except for the starter, alternator and power steering pump.

 This part is intended for competition use only. See page 2 for complete details.

ADDITIONAL BUILD OPTIONS

19433750 🏆

L8T Long Block

In addition to the complete L8T crate engine Chevrolet Performance offers the L8T Long Block — the high-output, direct-injected foundation of the Gen V Small-Block-based 6.6L engine offered in the Silverado 2500HD and 3500HD models.

Our L8T Long Block includes the direct injection cylinder heads and coil-on-plug ignition system, as well as the oil pan with dipstick, but does not include the intake manifold, throttle body, engine-mounted high-pressure direct injection fuel pump or fuel injectors. All must be sourced separately to complete the engine assembly. Additionally, the Front End Accessory Drive system is not included. See Installation Notes for recommendations.



TRANSMISSION OPTIONS

See pages 20–31 for additional options.

19432682 or 19432684

SuperMatic™ 6L80-E Six-Speed Automatic
(remanufactured)

page 26



19435613

SuperMatic™ 10L90-E Ten-Speed Automatic

page 28



CONNECT & CRUISE CONFIGURATIONS

Chevrolet Performance's Connect & Cruise systems match our crate engines with transmissions for factory-tailored performance combinations—including supporting controllers and installation kit recommendations—that take the guesswork out of your project. See page 32 for more details.

2024+ L8T with 6L80-E Automatic Transmission 🏆

Engine:	19435733	Install Kit:	19435470
Engine Controller:	19435726	Torque Converter:	included with trans.
Transmission:	19432682 or 19432684	Trans. Controller:	included with trans.

L8T with 10L90-E Automatic Transmission 🏆

Engine:	19435733 (2024+)	Install Kit:	19420810
Engine Controller:	19435606	Torque Converter:	included with trans.
Transmission:	19435613	Trans. Controller:	included with trans.



ENGINE-RELATED PARTS & ACCESSORIES

19433745

L8T/L8P 6.6L Truck Accessory Drive System — with A/C

Based on production accessory drive system used on Silverado HD models. Includes variable-displacement air conditioning compressor, alternator, hydraulic power steering pump, brackets, pulleys, tensioners, belts and instruction sheet. *page 107*

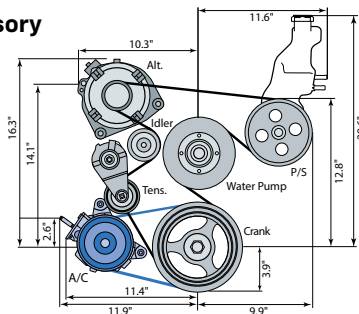

19433746

L8T/L8P 6.6L Truck Accessory Drive System — without A/C
(not shown)

Same as PN 19433745 but without air conditioning. *page 107*

19540199

L8T/L8P 6.6L Passenger Car Accessory Drive System — with A/C

Based on production accessory drive system used on GMT610 models. This kit is intended for passenger cars. Includes variable-displacement air conditioning compressor, alternator, hydraulic power steering pump, hose, remote reservoir, tensioners, belts and instruction sheet. *page 107*

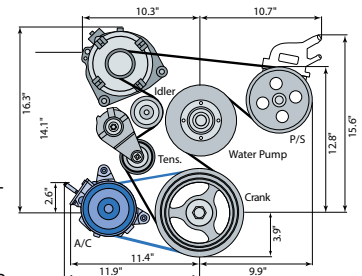

19540200

L8T/L8P 6.6L Passenger Car Accessory Drive System — without A/C
(not shown)

Same as PN 19540199 but without air conditioning. *page 107*

19435726 🏆

2024+ L8T Controller Kit for 6L80-E Transmission
(not shown)

Includes all components needed to run the L8T crate engine, P/N 19435733 with a 6L80-E automatic transmission only. *page 115*

19435606 🏆

L8T Controller Kit for 10L90-E Transmission
(not shown)

Includes all components needed to run the L8T crate engine, P/N 19435733 with a 10L90-E automatic transmission only. *page 115*



Parts intended for competition use only. See page 2 for details.



Performance

L8P

19435523 

523 hp

@ 5,800 rpm

543 lb.-ft.

@4,600 rpm

DYNO CHART

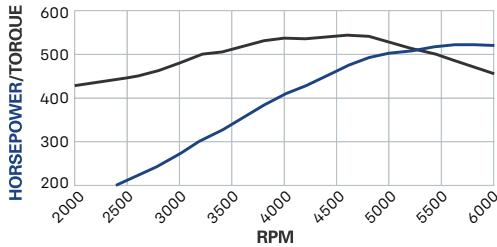

NOTE: Refer to page 6 for the complete horsepower and torque testing procedures.



More Power from Our Largest Displacement LT Engine!

We've optimized every cubic inch of our largest-displacement LT engine with the unique L8P performance crate engine. With 523 horsepower and 543 lb.-ft. of torque, this package combines the displacement and heavy-duty strength of our production-based L8T 6.6L engine plus a unique LT2-based camshaft.

It's all rooted in the tough foundation of the L8T, with a forged steel crankshaft, high-strength parts, high-flow heads and composite intake manifold. We then add a more performance-oriented valvetrain, including valves, springs, and a unique non-AFM (Active Fuel Management) LT2-based camshaft. The net result is an increase of 122 horsepower and 79 lb.-ft. of torque over the production 6.6L engine.

Our L8P crate engine package comes complete from the throttle body to the oil pan, including the PCV tube, evap tube, oil dipstick, oil fill tube and cap. It does not include the controller, harness, oxygen sensors or a Front-End Accessory Drive system. See Installation Notes below for recommendations.

INSTALLATION NOTES

- Engine is shipped with high-pressure direct-injection fuel pump installed
- Front End Accessory Drive system must be ordered separately and includes hydraulic power steering, with center pulley. Pulley-mounted fan not recommended. See page 107 for options.
- Includes 8-bolt flexplate for automatic transmissions
- Use with Engine Control kit 19435524 (must use 6L80-E transmission) See page 115 for details

Mobil 1 is the recommended engine oil for all Chevrolet Performance Engines

TECH SPECS

Part Number:	19435523
Engine Type:	Gen V Small Block V-8 direct injection spark ignition
Displacement (cu in):	400 (6.6L)
Bore x Stroke (in / mm):	4.065x3.860 (103.25 mm x 98 mm)
Block (P/N 19420904):	Cast iron with 6-bolt nodular main bearing caps
Crankshaft (P/N 12708884):	Forged steel
Connecting Rods (P/N 12675746):	Forged powder-metal
Pistons (P/N 12737834-R, 12737835-L):	Hypereutectic aluminum
Camshaft Type (P/N 12736191):	Billet steel hydraulic roller
Valve Lift (in):	0.549 intake / 0.549 exhaust
Camshaft Duration (@ 0.050 in):	218° intake / 231° exhaust
Cylinder Heads (P/N 12736192):	Aluminum rectangular port D/I with 59.02cc chambers
Valve Size (in):	2.130 hollow intake / 1.590 sodium-filled exhaust
Compression Ratio:	10.8:1
Rocker Arms (P/N 12619829):	Investment cast roller trunnion
Rocker Arm Ratio:	1.8:1
Intake manifold (P/N 12639087):	Composite
Throttle body (P/N 12730580):	87mm diameter (single-bore)
Fuel delivery:	High-pressure direct injection (2,175 psi / 150 bar)
Recommended Fuel:	Premium unleaded - 91 (R+M)/2
Ignition system:	Coil-on-plug
Maximum Recommended RPM:	6000 rpm
Reluctor wheel:	58X
Balanced:	Internal



Chevrolet Performance Crate Engines include a 24-month or 50,000-mile/80,000-kilometer limited warranty, whichever comes first. See your GM dealer for details.



Chevrolet Performance does not utilize any used or remanufactured parts in this crate engine, except for the starter, alternator and power steering pump.



This part is intended for competition use only. See page 2 for complete details.

UNIQUE COMPONENTS FOR THE L8P

L8P Cylinder Heads and Camshaft

The cylinder heads and camshaft are the key components in helping the L8P achieve 523 horsepower and 543 lb.-ft. of torque. The aluminum cylinder head is based on the L8T production head, but with a specific performance-oriented valvetrain featuring unique valve springs and intake valves.

The L8P's special camshaft is based off the Corvette Stingray's LT2 engine. This unique camshaft is NON AFM (Active Fuel Management) and features more duration than its production counterpart.

- **Camshaft type:** Billet steel hydraulic roller
- **Camshaft lift (in.):** 0.549 (intake) / 0.549 (exhaust)
- **Camshaft duration (deg.):** 218 (intake) / 231 (exhaust)
- **Centerline (deg.):** LSA = 121



TRANSMISSION OPTIONS

See pages 20–31 for additional options.

SuperMatic™ 6L80-E Six-Speed Automatic

19432682 (2400-2800 stall)

19432684 (3000-3400 stall)

Based on GM's production electronically controlled six-speed automatic transmission, but strategically strengthened for high-performance applications (650 lb.-ft.), the SuperMatic™ 6L80-E is a high-tech complement for LS and LSX combinations. Includes torque converter (2400-2800 stall or 3000-3400 stall). See page 26 for more details.

NOTE: The 6L80-E requires the use of a Chevrolet Performance Engine Controller kit to function with the L8P, will not function with carbureted manifold or aftermarket control systems.



CONNECT & CRUISE CONFIGURATIONS

Chevrolet Performance's Connect & Cruise systems match our crate engines with transmissions for factory-tailored performance combinations—including supporting controllers and installation kit recommendations—that take the guesswork out of your project. See page 32 for more details.

L8P with 6L80-E Automatic Transmission

Engine:	19435523	Install Kit:	19435470
Engine Controller:	19435524	Torque Converter:	included with trans.
Transmission:	19432682 or 19432684	Trans. Controller:	included with trans.



ENGINE-RELATED PARTS & ACCESSORIES

19433745

L8T/L8P 6.6L Truck Accessory Drive System — with A/C

Based on production accessory drive system used on Silverado HD models. Includes variable-displacement air conditioning compressor, alternator, hydraulic power steering pump, brackets, pulleys, tensioners, belts and instruction sheet. *page 107*

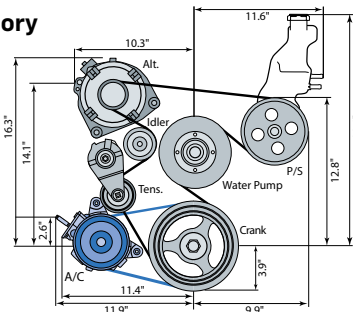

19433746

L8T/L8P 6.6L Truck Accessory Drive System — without A/C (not shown)

Same as PN 19433745 but without air conditioning. *page 107*

19540199

L8T/L8P 6.6L Passenger Car Accessory Drive System — with A/C

Based on production accessory drive system used on GMT610 models. This kit is intended for passenger cars. Includes variable-displacement air conditioning compressor, alternator, hydraulic power steering pump, hose, remote reservoir, tensioners, belts and instruction sheet. *page 107*

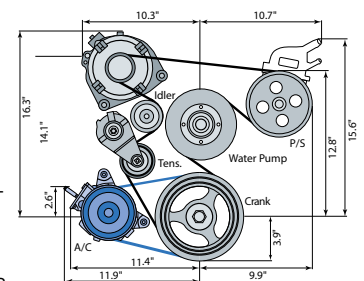

19540200

L8T/L8P 6.6L Passenger Car Accessory Drive System — without A/C (not shown)

Same as PN 19540199 but without air conditioning. *page 107*

19435524

L8P Controller Kit

Includes all components needed to run the L8P crate engine, P/N 19435523 with a 6L80-E automatic transmission only. Includes E-93 controller, Fuel Pump Power Module, High Pressure Fuel Sensor and all other components needed for proper operation. *page 115*



Parts intended for competition use only. See page 2 for details.



Performance



E-Rod

Crate Engine systems



Street-Legal Power from Chevrolet Performance!

With Chevrolet Performance's E-ROD high-performance crate engine systems, you'll build your project with 50-state street-legal power!

E-ROD crate engine systems have been granted official California Air Resources Board (CARB) E.O. numbers, making them street legal for installation in millions of 1995-and-earlier vehicles in all 50 states.

That means you can build the car or truck of your dreams, with the assurance that the engine and supporting components have been granted an official CARB E.O. number.

The E-ROD lineup includes the LT1 6.2L and the LT4 supercharged 6.2L. Each crate engine system includes emissions equipment and more, and each is available as a Connect & Cruise combination that matches it with a complementing transmission, including Chevrolet Performance's latest 6L80-E, 8L90-E and 10L90-E automatic transmissions (see pages 26-28).

LT1 6.2L

CARB EO#: D-126-54

LT4 6.2L

CARB EO#: D-126-55



This part is 50 state emissions street legal when installed and used as described in the CARB executive order.

See page 2 for details



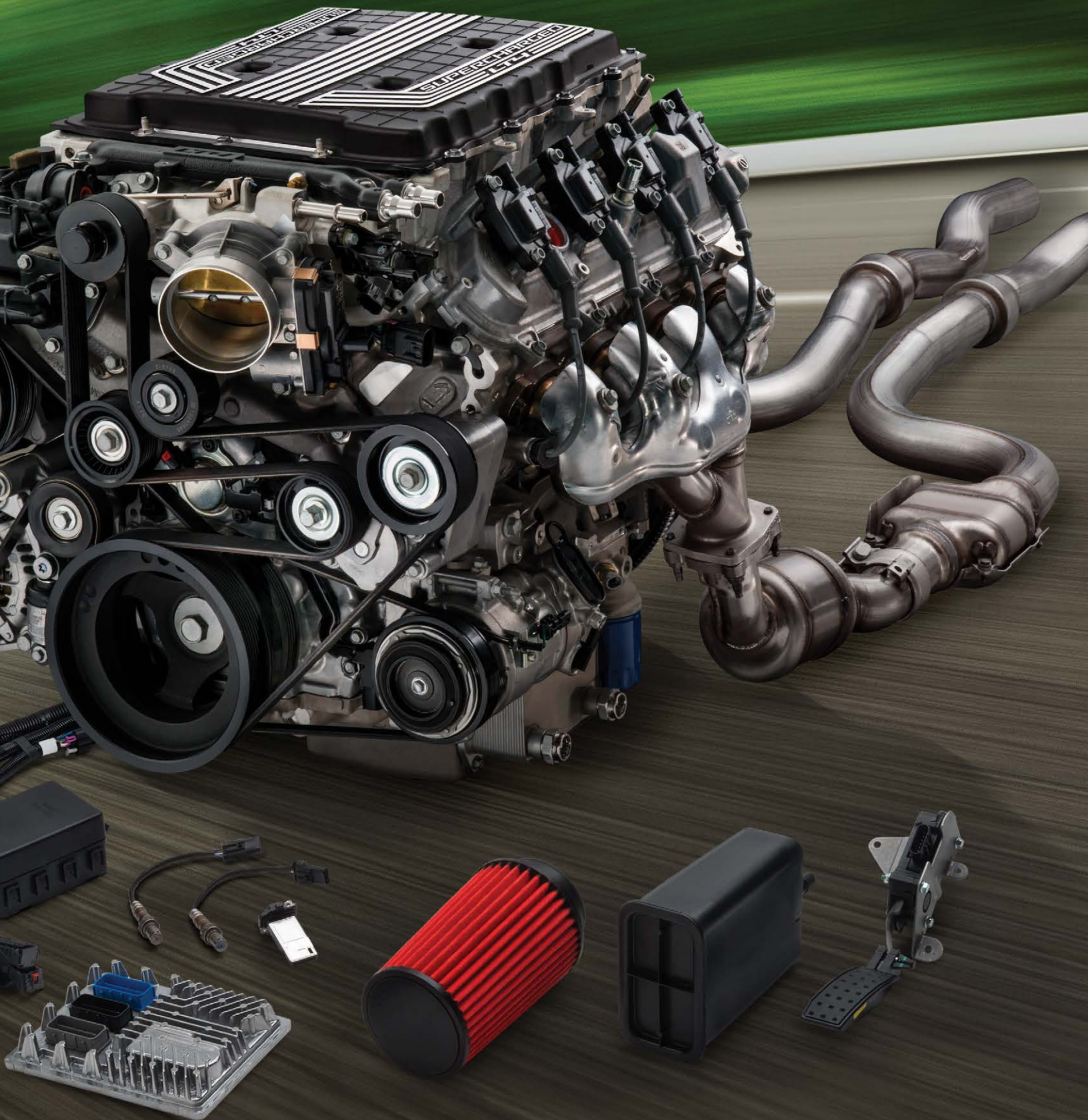

E-ROD Systems Have it All

Each E-ROD crate engine system carries an official California Air Resources Board (CARB) E.O. number and includes complete emissions equipment, along with the engine controller and harness needed to get the engine running. The primary elements of each kit include:

- **Chevrolet Performance crate engine**
- **Engine control module**
- **Exhaust manifolds**
- **Catalytic converters**
- **Mass airflow sensor and sensor boss**
- **Oxygen sensors and sensor bosses**
- **Air filter**
- **Accelerator pedal**
- **Evaporative emissions canister**
- **Instruction manual**



LT1 System Shown



E-ROD LT1 6.2L Wet Sump System

- **CARB EO#: D-126-54**
- **Horsepower: 455 @ 6,000 rpm**
- **Torque: 455 lb.-ft. @ 4,400 rpm**



Chevrolet Performance's LT1 crate engine is architecturally similar to the LS family of Small-Block engines, but with a unique block casting, cylinder head design, oiling system and more. It also combines advanced technologies, including direct injection and continuously variable valve timing, to support an advanced combustion system. It is offered with a wet-sump oiling system and a controller specially designed for retro-fit applications.

Part Number	Description
19433063	w/4L and Super Magnum 6-Speed Manual
19433869	w/6L
19433059	w/8L and 10L

See page 68 for complete engine details.

Also available as a Connect & Cruise Package (see page 32).





E-ROD LT4 6.2L SC Wet Sump System

- **CARB EO#:** D-126-55
- **Horsepower:** 650 @ 6,400 rpm
- **Torque:** 650 lb.-ft. @ 3,600 rpm



The latest addition to the E-ROD family of 50-state street legal engines is the LT4, the supercharged big brother of the direct injected LT1, delivering a smooth 650 horsepower. Original equipment in the ZO6 Corvette and the ZL1 Camaro.

Part Number	Description
19433071	w/4L and Super Magnum 6-Speed Manual
19433872	w/6L
19433067	w/8L and 10L

See page 70 for complete engine details.

Also available as a Connect & Cruise Package see page 32).

BUILDER'S NOTE

To facilitate a complete E-ROD installation, the builder will need to source additional components to complete the assembly and get the vehicle running, including:

- Fuel tank
- Fuel lines (returnless)
- Fuel Pumps: 45 G/H (gallons per hour) at 58 psi (400 kPa) for all non-boosted engines (LS and LT). 65 G/H (gallons per hour) at 72 psi (500 kPa) for LT4 and all boosted engines (LS and LT)
- Fuel tank vent line from the tank to the evaporative emissions canister
- Purge line from the canister to the engine purge solenoid
- Air induction system that incorporates the mass airflow sensor
- Exhaust system behind the catalytic converters

All E-ROD engines require a front-end accessory drive system suitable to the vehicle. The instruction manual included with each kit offers recommendations for the accessory drive kit, as well as the transmission, gear ratios and more. Chevrolet offers several configurations of accessory drive systems to suit different applications, and each allows the installer to easily delete air conditioning. See pages 104–107 for applications and part numbers.

Chevrolet Performance recommends the LT1 Engine Installation Guide P/N 19433066 and the LT4 Engine Installation Guide P/N 19433070. Both guides illustrate basic procedures and offer helpful tips on installing an LT engine into older vehicles.

E-ROD systems do not come with a transmission. Chevrolet Performance recommends the following four-speed, six-

speed, eight-speed and ten-speed automatic transmissions and transmission controllers. The six-, eight- and ten-speed transmission kits include a torque converter and transmission controller. They must be purchased separately with the four-speed transmissions:

Engine	Transmission	Transmission Part Number	Torque Converter	Transmission Controller
LT1	SuperMatic™ 4L70-E	19368614	19299802	19302405
	SuperMatic™ 6L80-E	19432682, 19432684, 19435284 or 19435286	included	included
	SuperMatic™ 8L90-E	19419798	included	included
	SuperMatic™ 10L90-E	19436466	included	included
LT4	SuperMatic™ 4L75-E	19368615	19299802	19302405
	SuperMatic™ 6L80-E	19432682, 19432684, 19435284 or 19435286	included	included
	SuperMatic™ 8L90-E	19419799	included	included
	SuperMatic™ 10L90-E	19436467	included	included

A six-speed Super Magnum manual transmission is also available for all E-ROD engines.

NOTE: In addition to the recommended transmission, torque converter and transmission control kit, an additional adapter or transmission installation kit may be required. See the Transmissions and Components section (page 20) for applications and recommendations.



This part is 50 state emissions street legal when installed and used as described in the CARB executive order. See page 2 for details





SMALL-BLOCK

LSX-Series

Crate Engines



LSX – LS performance with an iron block foundation

When it comes to LSX crate engine performance, Chevrolet Performance starts with our strongest foundation: The LSX cast-iron block. Designed to support higher power outputs than our production-based aluminum LS cylinder blocks, including with supercharging, turbocharging and nitrous, our LSX-based crate engines are tested and proven on the drag strip. The strong, forged crankshafts and pistons provide the power you need with the strength you can rely on, race after race!

Check out the following pages to find the Chevrolet Performance LSX Engine that's right for you!

LSX376-B15	82
LSX454	84

NOTE: LSX376-B15 and LSX454 engines do not include intake manifolds, oil pans, water pumps, or front drive assemblies





Engines shown from left:
LSX376-B15, LSX454

LSX376-B15

19417356 

473 hp

@ 6,000 rpm

444 lb.-ft.

@ 5,000 rpm

DYNO CHART

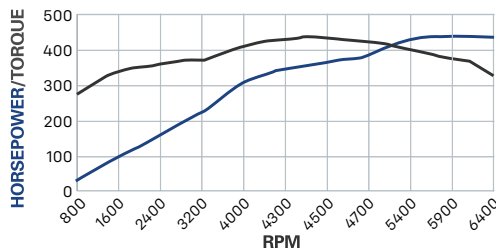

NOTE: Refer to page 6 for the complete horsepower and torque testing procedures.



Forged internals support higher boost!

If you want to stretch the performance of a turbocharged or supercharged combination, Chevrolet Performance's LSX376-B15 is the foundation you need! Its durable, all-forged rotating assembly supports up to 15 pounds of boost—and our ratings of 473 horsepower and 444 lb.-ft. of torque are only baseline numbers of what this engine can offer.

The LSX376-B15 includes the six-bolt high-flow, rectangular-port LSX-LS3 heads. Additionally, we deliver the engine without an intake manifold and other accessories, allowing you to tailor the induction system and other features to suit the forced-induction setup of your choice.

Our horsepower and torque ratings are based on testing with the production-style, normally aspirated fuel injection system. The power you make with a supercharger or turbo will vary.

INSTALLATION NOTES

- Assembly does not include any electronics
- Not intended for marine applications
- Requires LS/LSX Ignition Controller P/N 19355418 for carbureted applications (see page 113)
- LSX 8-bolt crank flange
- Assembly shipped without an intake manifold (see page 109)
- Requires the purchase and installation of an oil pan (see page 109) (dust shield installed for shipment)
- Recommended max boost—15 psi
- Use LS376/525 engine control kit P/N 19354332 for fuel injected applications
- Calibration provided with control kit LS376/525 P/N 19354332 may need to be modified to match the remaining hardware selected for the application

Mobil 1 is the recommended engine oil for all Chevrolet Performance Engines

TECH SPECS

Part Number:	19417356
Engine Type:	LSX-Series Gen IV Small-Block V-8
Displacement (cu in):	376 (6.2L)
Bore x Stroke (in):	4.065 x 3.622 (103.25 x 92 mm)
Block (P/N 19417352):	LSX cast iron with 6-bolt, cross-bolted main caps
Crankshaft (P/N 12603616):	Forged steel
Connecting Rods (P/N 12604857):	Forged powder metal
Pistons (P/N 19259381):	Forged aluminum
Camshaft Type (P/N 12638426):	Hydraulic roller
Valve Lift (in):	.560 intake / .555 exhaust
Camshaft Duration (@.050 in):	210° intake / 230° exhaust
Cylinder Heads (P/N 19419187):	LSX-LS3 rectangular port; with "as cast" 68cc chambers and 6-bolt attachment
Valve Size (in):	2.160 intake / 1.550 exhaust
Compression Ratio:	9.0:1
Rocker Arms (P/N 12669995 int):	Investment-cast, roller trunnion
Rocker Arms (P/N 12681275 exh):	Investment-cast, roller trunnion
Rocker Arm Ratio:	1.7:1
Recommended Fuel:	Regular pump
Maximum Recommended rpm:	6,600
Reluctor Wheel:	58x
Balanced:	Internal



Chevrolet Performance Crate Engines include a 24-month or 50,000-mile/80,000-kilometer limited warranty, whichever comes first. See your GM dealer for details.



Chevrolet Performance does not utilize any used or remanufactured parts in this crate engine, except for the starter, alternator and power steering pump.



This part is intended for competition use only. See page 2 for complete details.

TRANSMISSION OPTIONS

See pages 20–31 for additional options.

19300175**SuperMatic™ 4L85-E Four-Speed Automatic**

Based on the 4L80-E, the 4L85-E electronically controlled four-speed automatic is rated for up to 690 lb.-ft. of torque. For strength, it features five-pinion gearsets and additional clutch plates, while unique hardware delivers firmer shifts than production 4L85 transmissions. Does not include converter. Use with electronic controller P/N 19302410 for LS/LSX-based fuel-injected engines. See page 25 for more details.

**SuperMatic™ 6L80-E Six-Speed Automatic****19366637** (2400–2800 stall)**19417102** (3000–3400 stall)

Based on GM's production electronically controlled six-speed automatic transmission, but strategically strengthened for high-performance applications (650 lb.-ft.), the SuperMatic™ 6L80-E is a high-tech complement for LS and LSX combinations. Includes torque converter (2400–2800 stall or 3000–3400 stall). See page 26 for more details.

NOTE: The 6L80-E requires the use of a Chevrolet Performance Engine Controller kit to function with the LSX376-B15, will not function with carbureted manifold or aftermarket control systems.

**19352208****Super Magnum Six-Speed Manual**

This high-torque capacity TREMEC six-speed manual is designed for custom, retro-fit installations with Chevrolet Performance crate engines. It has a 700-lb.-ft. torque capacity and features a 40-tooth reluctor ring that's necessary for use with the electronic vehicle speed sensors used with Chevrolet Performance controllers. See page 29 for more details.



ENGINE-RELATED PARTS & ACCESSORIES

**19212593**
Muscle Car
Oil Pan Kit

page 109

**19540154** 
LS3 Intake Manifold
Assembly

page 109

**19302410**
Transmission Controller

page 28

**13597903** 
LSA/LS9 Intercooler
Fluid Pump

page 109

**19301246** 
Air Inlet Kit for LS-Based
Crate Engine Installation

page 109

Parts intended for competition use only.
See page 2 for details.

Performance

83

LSX454

19417357 

627 hp

@ 6,300 rpm

586 lb.-ft.

@ 5,100 rpm

DYNO CHART

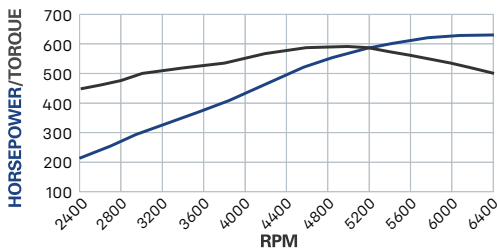

NOTE: Refer to page 6 for the complete horsepower and torque testing procedures.

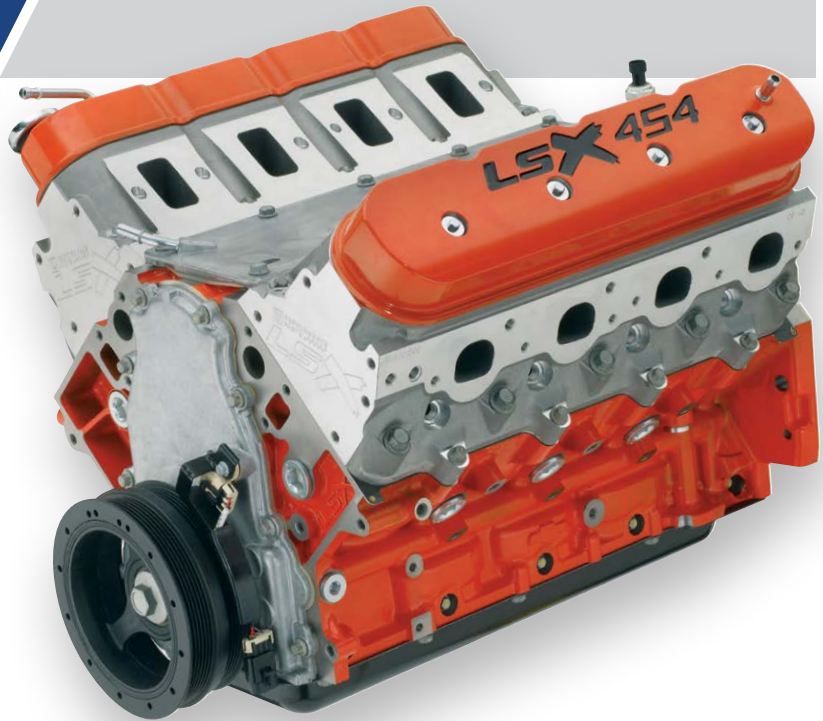

An LSX with big-block torque!

With the LSX Bowtie block, we've built a 21st century 454 with our latest technology. It's lighter and more compact than an original Big-Block 454—and it delivers the stunning, big-torque output you expect: 586 lb.-ft., along with 627 horsepower. Best of all, it requires no more space under the hood than a production LS engine.

The LSX454 is filled with an all-forged, super-tough rotating assembly and features a pair of our deep-breathing LSX six-bolt cylinder heads. It also comes dressed with great-looking, orange powder-coated valve covers with engraved LSX454 logos.

The LSX454 valve covers do not include provisions for mounting ignition coil brackets. Aftermarket or custom relocation brackets must be obtained. It also includes an 8-bolt crankshaft flange that may require an adapter for use with some transmissions.

INSTALLATION NOTES

- Assembly does not include any electronics
- Requires LS7 pattern intake manifold
- Assembly shipped without an intake manifold (see page 109)
- Requires the purchase and installation of an oil pan (see page 109) (dust shield installed for shipment)
- Not intended for marine applications
- Requires LS/LSX Ignition Controller P/N 19355418 when using a carburetor (see page 113)
- LSX 8-bolt crank flange
- Requires premium fuel
- Use LSX454 control kits for fuel injected applications (P/N 19354342 for automatic transmissions or P/N 19369179 for manual transmissions)

Mobil 1 is the recommended engine oil for all Chevrolet Performance Engines

TECH SPECS

Part Number:	19417357
Engine Type:	LSX-Series Gen IV Small-Block V-8
Displacement (cu in):	454 (7.4L)
Bore x Stroke (in):	4.185 x 4.125 (106.3 x 104.8 mm)
Block (P/N 19417353):	LSX cast iron with 6-bolt, cross-bolted main caps
Crankshaft (P/N 19244018):	4340 forged steel with 8-bolt flange
Connecting Rods (P/N 19166964):	4340 forged steel
Pistons (P/N 19166958):	Forged aluminum
Camshaft Type (P/N 19166972):	Hydraulic roller
Valve Lift (in):	.648 intake / .648 exhaust
Camshaft Duration (@.050 in):	236° intake / 246° exhaust
Cylinder Heads (P/N 19419193):	Aluminum LSX-LS7 port; with "as cast" 70cc chambers
Valve Size (in):	2.200 titanium intake/1.610 hollow, sodium-filled exhaust
Compression Ratio:	11.0:1
Rocker Arms (P/N 12579615 int):	Investment-cast, roller trunnion
Rocker Arms (P/N 12579617 exh):	Investment-cast, roller trunnion
Rocker Arm Ratio:	1.8:1
Recommended Fuel:	Premium pump
Maximum Recommended rpm:	7,100
Reluctor Wheel:	58x
Balanced:	Internal



Chevrolet Performance Crate Engines include a 24-month or 50,000-mile/80,000-kilometer limited warranty, whichever comes first. See your GM dealer for details.



Chevrolet Performance does not utilize any used or remanufactured parts in this crate engine, except for the starter, alternator and power steering pump.



This part is intended for competition use only. See page 2 for complete details.

TRANSMISSION OPTIONS

See pages 20–31 for additional options.

19300175

SuperMatic™ 4L85-E Four-Speed Automatic

Based on the 4L80-E, the 4L85-E electronically controlled four-speed automatic is rated for up to 690 lb.-ft. of torque. For strength, it features five-pin gearsets and additional clutch plates, while unique hardware delivers firmer shifts than production 4L85 transmissions. Does not include converter. Use with electronic controller P/N 19302410 for LS/LSX-based fuel-injected engines. See page 25 for more details.



SuperMatic™ 6L80-E Six-Speed Automatic

19366637 (2400-2800 stall)

19417102 (3000-3400 stall)

Based on GM's production electronically controlled six-speed automatic transmission, but strategically strengthened for high-performance applications (650 lb.-ft.), the SuperMatic™ 6L80-E is a high-tech complement for LS and LSX combinations. Includes torque converter (2400-2800 stall or 3000-3400 stall). See page 26 for more details.



NOTE: The 6L80-E requires the use of a Chevrolet Performance Engine Controller kit to function with the LSX454 (see page 115), will not function with carbureted manifold or aftermarket control systems.

19352208

Super Magnum Six-Speed Manual

This high-torque capacity TREMEC six-speed manual is designed for custom, retro-fit installations with Chevrolet Performance crate engines. It has a 700-lb.-ft. torque capacity and features a 40-tooth reluctor ring that's necessary for use with the electronic vehicle speed sensors used with Chevrolet Performance controllers. See page 29 for more details.



ENGINE-RELATED PARTS & ACCESSORIES



19302410
Transmission Controller

page 28



LSX454 Engine Controller Kit

19369179 Manual
19354342 Automatic
page 115



19355418
LS/LSX Ignition Controller

page 113



19301246
Air Inlet Kit for LS-Based Crate Engine Installation

page 109

LSX454 COMPLETION COMPONENTS

Carburetor Fuel System

Carburetor	19420446
Air cleaner	12342071
Ignition controller	19355418
Ignition coil kit	19367577
Fuel pump	6472657

Electronic Fuel Injection

Ignition coil kit	19367577
Engine controller kit for manual transmission	19369179
Engine controller kit for automatic transmission	19354342
High flow/60PSI (400kPa) fuel pump	not available from Chevrolet Performance



Parts intended for competition use only. See page 2 for details.



Performance

LS/LT/LSX-Series

Engine Components

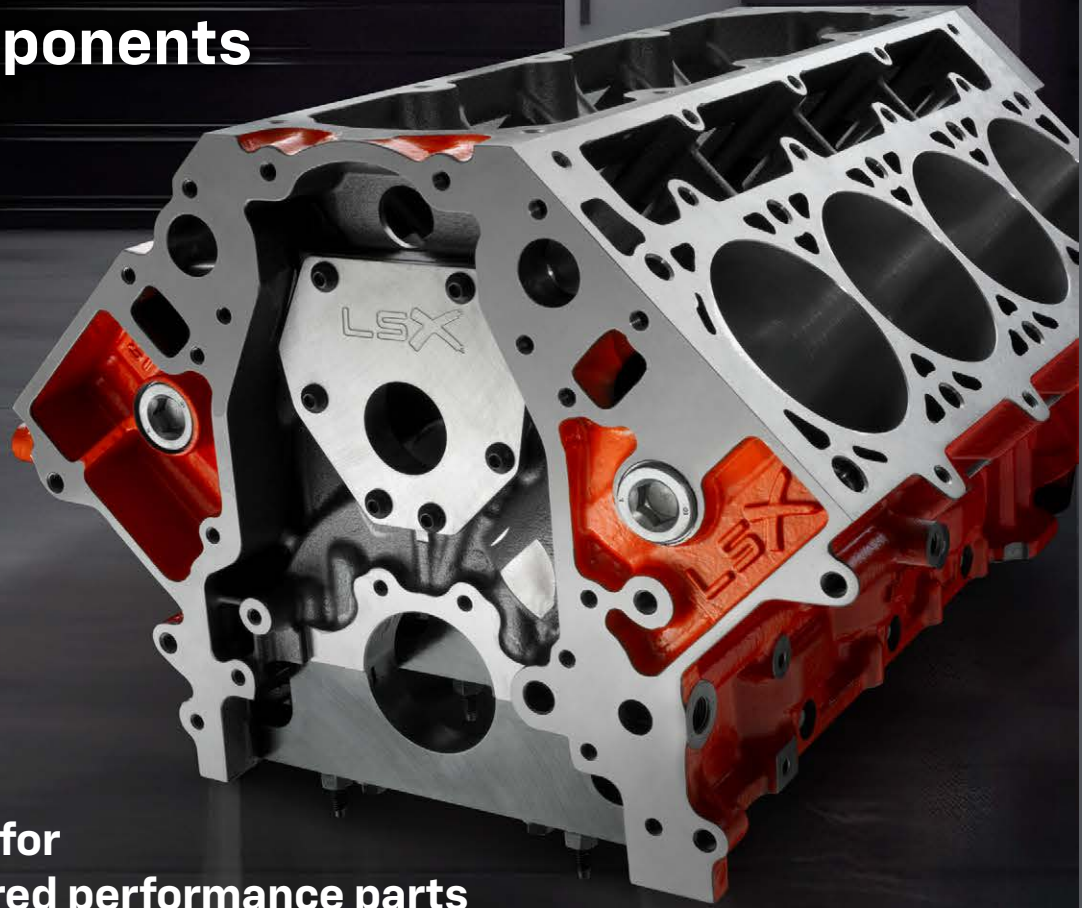

Your only source for factory-engineered performance parts

With LS and LT engine swaps and performance upgrades more popular than ever, it's important to remember Chevrolet Performance is your only source for factory-engineered engine parts—from blocks, cylinder heads and rotating components to the fuel, air and spark parts for carbureted and fuel-injected combinations.

And speaking of combinations, our portfolio is one of the most comprehensive in the industry, with more than 20 cylinder head choices, more than a dozen performance camshafts and scores of additional factory-engineered parts that can be combined to build an LS or LT engine like no other.

For those taking performance to the highest levels, Chevrolet Performance's exclusive LSX Series offers the ultimate in track-tested strength, with blocks, six-bolt heads and forged internal parts designed to support power adders such as turbochargers and superchargers. They're the strongest parts we have for building LS power.

No other source offers factory-engineered LS, LT and LSX engine parts for your project—and nobody knows how to build LS/LT performance like Chevrolet Performance!

You can find these Chevrolet Performance LS/LT/LSX Engine Components on the following pages:

BLOCKS AND COMPONENTS	87	CRANKSHAFTS	102
CYLINDER HEADS	92	ACCESSORY DRIVE SYSTEMS	104
VALVE COMPONENTS	97	OIL PANS, OIL PUMPS, GASKETS AND COMPONENTS ...	109
VALVE COVERS	98	INTAKE MANIFOLDS	109
CAMSHAFTS	99	ELECTRICAL AND FUEL COMPONENTS	113
PISTONS AND PISTON RINGS	101	ENGINE CONTROL MODULES	114

LS/LT/LSX-Series Blocks and Components

QUICK REFERENCE CHART

Production Cylinder Blocks

Origin	Part Number	Material	Deck Height	Bore	Main Bolt	Cap Material	Crank Jnl. Dia.	Oiling	Rear Main Seal	Max Stroke	Max HP	Usage	Page Number
LS1/LS6	12561166 (Disc.)	Alum	9.240"	3.898"	6	Iron	Std. LS (2.56")	Wet/Dry	1 pc	4.00"	450	Street	N/S
Gen III 6.0L	12733807	Iron	9.240"	4.000"	6	Iron	Std. LS (2.56")	Wet/Dry	1 pc	4.00"	450	Street	87
Gen IV 6.0L	19369841 (Disc.)	Iron	9.240"	4.000"	6	Iron	Std. LS (2.56")	Wet/Dry	1 pc	4.00"	500	Street	N/S
LS3/L92	12729604	Alum	9.240"	4.065"	6	Iron	Std. LS (2.56")	Wet/Dry	1 pc	4.00"	525	Street	88
LSA	12673476	Alum	9.240"	4.065"	6	Nodular Iron	Std. LS (2.56")	Wet/Dry	1 pc	4.50"	800	Street/Pro	88
LS9	12623969 (Disc.)	Alum	9.240"	4.065"	6	1045 Steel	Std. LS (2.56")	Wet/Dry	1 pc	4.50"	900	Street/Pro	N/S
LS7	19213580 (Disc.)	Alum	9.240"	4.125"	6	Steel	Std. LS (2.56")	Wet/Dry	1 pc	4.10"	550	Street	N/S
LT1	19431901	Alum	9.240"	4.065"	6	Nodular Iron	Std. LS (2.56")	Wet/Dry	1 pc	4.125"	755	Street	88
LT2	19436362	Alum	9.240"	4.06"	6	Nodular Iron	Std. LS (2.56")	Wet/Dry	1 pc	3.62"	495	Street	88
Gen V 6.6L	19420904	Iron	9.240"	4.065"	6	Nodular Iron	Std. LT (2.56")	Wet/Dry	1 pc	—	—	Street	88

LSX Bowtie Blocks

Origin	Part Number	Material	Deck Height	Bore	Main Bolt	Cap Material	Crank Jnl. Dia.	Oiling	Rear Main Seal	Max Stroke	Max HP	Usage	Page Number
LSX	19417351*	Iron	9.260"	3.880"	6	1045 Steel	Std. LS (2.56")	Wet/Dry	1 pc	4.25"	1500+	Street/Pro	90
LSX	19417354*	Iron	9.720"	3.880"	6	1045 Steel	Std. LS (2.56")	Wet/Dry	1 pc	4.50"	1500+	Street/Pro	90
LSX	19419982*	Iron	9.700"	3.880"	6	1045 Steel	Std. LS (2.56")	Wet/Dry	1 pc	4.50"	1500+	Street/Pro	90
LSX	19417352**	Iron	9.240"	4.065"	6	1045 Steel	Std. LS (2.56")	Wet/Dry	1 pc	4.25"	1500+	Street/Pro	90
LSX	19417353**	Iron	9.240"	4.185"	6	1045 Steel	Std. LS (2.56")	Wet/Dry	1 pc	4.25"	1500+	Street/Pro	90

*Semi-finished block

**Full machined block

Deck Height Diagram

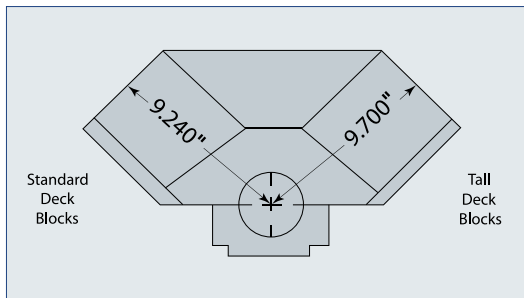

LT1/LT4/LT5 Aluminum 6.2L Bare Block (top, rear)

PRODUCTION CYLINDER BLOCKS

The LS-Series cylinder block is the foundation for the serious performance achievements that are driving a new generation of performance enthusiasts. Features include a deep-skirt casting (the block side extends below the crankshaft centerline), 6-bolt cross-bolted main caps, strong and lightweight aluminum alloy casting (most production blocks) and provisions for the latest in engine control management. The cam-in-block configuration brings inherent torque to every LS engine, with production-based blocks capable of supporting combinations of 500 horsepower or more. The Corvette ZR1's unique 6.2L block, for example, supports the engine's 638-horsepower rating. Chevrolet Performance's high-performance iron LSX cylinder block supports more than 2,000 forced-induction horses!

Using a new production-validated cylinder block assures you a strong, dimensionally correct foundation for your project engine.



LT1/LT4/LT5 Aluminum 6.2L Bare Block (bottom, rear)

Part Number	Description	Technical Notes
12733807	Gen III 6.0L Cast-Iron Block (not shown)	Production cast-iron block; Production oiling system; 6-bolt iron main bearing caps; 4.000" bore (101.6mm); 9.240" deck height; No provision for Active Fuel Management; Supports 500+ horsepower!







Parts intended for competition use only. See page 2 for details.



Performance

LS/LT/LSX-SERIES COMPONENTS

Production Cylinder Blocks continued

Part Number	Description	Technical Notes
12729604 	LS3/L92 Aluminum 6.2L Bare Block	Direct replacement for: 2009–2012 L9H, 2010–2012 L94, 2008–2013 LS3, 2010–2013 L99, 2007–2008 L92; Production aluminum block with iron sleeves; Production oiling system; Forged powdered metal 6-bolt main bearing caps; 9.240" deck height; Use only LS1, LS6, LS2, L92/LS3-style cylinder heads; 4.065" finished bore (103.25mm); Provisions for Active Fuel Management; Great for stroker cranks for even more cubes; Tested to over 500 horsepower
12673476 	LSA 6.2L Bare Block (not shown)	Direct replacement for 2009–2012 Cadillac CTS-V 6.2L supercharged engine and 2012 ZL1 Camaro; Production cast-aluminum block with iron sleeves; Production oiling system; 6-bolt iron main bearing caps; 9.240" deck height; Not for use with LS7 or LSX-LS7 heads; 4.065" finished bore (103.25mm); Includes oil squirters (8) for piston cooling; No provision for Active Fuel Management; Rated for more than 550 horsepower
25534412	Oil Hose Adapters (shown on page 91)	Kit adapts the production LS7 oil pan to aftermarket AN-style hoses for aftermarket dry sump oil tanks; Bolts directly to LS7 oil pan, and has AN male outlet for AN-12 fittings; Includes 1 adapter, 2 fittings, 2 bolts and 2 sealing gaskets
19431901 	LT1/LT4/LT5 Aluminum 6.2L Bare Block	Direct replacement for 2014–2019 Stingray and 2015–2020 Camaro SS LT1; Production aluminum block with iron sleeves; Production oiling system; 9.240" deck height; Nodular iron 6-bolt main bearing caps; Use only with LT1-style cylinder heads; 4.065" finished bore (103.25mm); Provisions for Active Fuel Management; Provision for direct fuel injection
19436362	LT2 Aluminum 6.2L Bare Block	Direct replacement for 2020–2024 Corvette Stingray; Production A319-T7 cast aluminum block with cast-in iron cylinder liners and 6-bolt nodular main bearing caps; Separate bay and valley; Provision for valley oil scavenge pump; Engine mounts bosses for Corvette C8; Transmission mount flange unique to Corvette DCT; Provision for block mounted coils; 4.06" (103.25 mm) finished bore; Used with a 3.62-inch (92mm)-stroke crankshaft; Rated for 495HP 470lb-ft of torque
19420904 	L8T Gen V 6.6L Cast-Iron Block	Direct replacement for 2020-and-later L8T 6.6L gas engines used in Silverado HD trucks; Production cast-iron casting finished with 4.065" (103.25 mm) cylinder bores; Used with a 3.86-inch-stroke crankshaft in production engines to produce 400-cubic-inch (6.6L) displacement – the largest displacement in the LT engine family; 9.240" deck height; Delivered bare, with regular-production six-bolt main caps; Regular-production oiling circuit; Includes provisions for direct fuel injection



LS3/L92 Aluminum 6.2L Bare Block
(top, front)



LS3/L92 Aluminum 6.2L Bare Block
(bottom, front)



LT1/LT4/LT5 Aluminum 6.2L Bare Block
(bottom, rear)



LT1/LT4/LT5 Aluminum 6.2L Bare Block
(top, front)



L8T GEN V 6.6L Cast-Iron Block

LSX BOWTIE BLOCK



Delivering the seemingly impossible combination of professional racing-level strength and entry-level affordability, the LSX Bowtie Block is our next revolution in high-performance engine-building. This durable iron-block casting is based primarily on GM's production LS7 block, but designed with more material in key areas—including thicker deck and bores—to support displacements of 454 cubic inches or more. Unique six-bolts-per-cylinder-head clamping capability enables forced-induction and nitrous combinations of greater than 2,000 horsepower.

Because the LSX Bowtie block is based on production LS blocks, all of the LS-Series Gen IV cylinder heads, crankshafts, oil pans, camshafts, and accessories bolt right up to it. There is also a tall-deck version for building even larger engines. Chevrolet Performance delivers the LSX Bowtie Block semi-finished, allowing you to finish it to your needs. Whether you're building a "tame" 800 horse bracket racer engine, or a 1,700 horsepower turbo engine for an Outlaw racer, the LSX Bowtie Block is the foundation for an unbeatable combination—at an unbeatable price!



LSX Bowtie Block (top, front)

LSX Bowtie Block specs and features include:



- CNC-machined cast-iron block
- True priority main oiling
- 6-head bolts per cylinder
- Standard 4.400" bore spacing
- Extra-thick siamese cylinder bores
- Semi-finished machined thicker decks
- LS7-Style, 6-bolt dowel-located billet main bearing caps
- Wet sump and dry sump oiling capability
- Production-style deep-skirt head bolt holes
- Production bolt hole and thread sizes
- Maintains production exterior accessory mounting provisions
- Front motor plate mounting holes added
- Additional material cast around cam bearings for greater strength
- 8mm exterior/interior fifth- and sixth-head bolt holes
- Standard .842" lifter bores
- Accommodates all LS oil pumps and oil pans
- External oil pump feed (rear of block)
- Main web bay-to-bay breathing holes to support greater horsepower
- Includes unique cam retainer, rear cover and lifter retainers

For the advanced LSX competition engine builder, you will fully enjoy the following features of the new LSX Bowtie Block:

- Front oil feed holes can be plugged/restricted for mechanical flat tappet or mechanical roller lifter applications
- Can be machined safely to 9.200" deck height
- Maximum 4.200" bore at .145" minimum wall thickness (naturally aspirated applications)
- Head bolt holes can be machined for ½" studs
- Front oil feed lines can be plugged and external oil pump and/or aftermarket dry sump systems can be used via oil pump feed at rear of block—may be required with certain large stroke/aluminum rod combinations
- Cam bores can be machined to accept 60mm roller bearings
- Can be machined for larger diameter lifters and/or 1.060" bronze bushings
- Belt cam drive systems can be accommodated, some machining will be required
- Front motor plate can be used for racing chassis applications (sprint car, drag racing, truck pulling, etc.)
- Threaded water plugs can be used for external heaters or coolers
- Extra stock for main bearing align-honed
- 400 MPa tensile strength iron



LSX Bowtie Blocks continued

Semi-Finished Blocks

Part Number	Description	Technical Notes
19417351 	LSX Bowtie Block – Semi-finished, Standard Deck	3.880" semi-finished siamese cylinder bores; 9.260" semi-finished standard deck height (ready to be decked); 4.250" maximum stroke (professional engine builders only!); Capable of 364- to 482-cubic-inch displacements; Orange powder-coated finish; Accepts all LS and LSX Series heads, cranks, cams, etc.; Approximate finished weight is 225 pounds
19417354 	LSX Bowtie Block – Semi-finished, Tall Deck (not shown)	3.880" semi-finished siamese cylinder bores; 9.720" semi-finished standard deck height (ready to be decked); 4.500" maximum stroke (small base circle camshafts required); Capable of 364- to 500-cubic-inch displacements or more!; Orange powder-coated finish; Accepts Gen IV LS and LSX Series heads, cranks, cams, etc.; Approximate finished weight is 250 pounds
19419982 	LSX Bowtie Block – Semi-finished, Tall Deck (not shown)	3.880" semi-finished siamese cylinder bores; 9.700" semi-finished standard deck height (ready to be decked); 4.500" maximum stroke (small base circle camshafts required); Capable of 364- to 500-cubic-inch displacements or more!; Orange powder-coated finish; Accepts Gen IV LS and LSX Series heads, cranks, cams, etc.; Approximate finished weight is 250 pounds

Finished Blocks

LSX finished blocks are completely machined and are ready for assembly. Save time and money.

Part Number	Description	Technical Notes
19417352 	LSX376 Production Block (not shown)	4.065" bore; Fully CNC machined; Deck plate honed; Align-honed main bearings; Deck height 9.240" (production); Billet-steel main caps; Includes all hardware; Used in LSX376 crate engine
19417353 	LSX454 Production Block (not shown)	4.185" bore; Fully CNC machined; Deck plate honed; Align-honed main bearings; Deck height 9.240" (production); Billet-steel main caps; Includes all hardware; Used in LSX454 crate engine

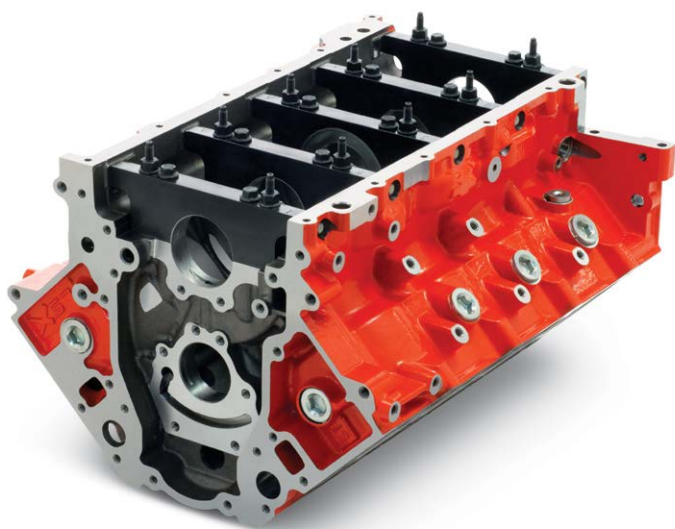

LSX Bowtie Block (bottom, front)



LSX Bowtie Block (top, rear)



Lifter Boss Detail



Bay-to-Bay Breathing Pocket Detail



Deck Detail

LSX Blocks include the following:

- 19244460 Cam Thrust Plate
- 19369274 Rear Cover
- 19166182 Tappet Guides

Other service parts for your LSX Block:

- 19166178 Gasket – Cam Thrust Plate, O-Ring
- 19166180 O-Ring – Rear Cover
- 19166181 O-Ring – Rear Cover
- 19211434 Main Cap Dowel (10-piece kit)

CYLINDER BLOCK COMPONENTS



LSX Block Completion Kit



Oil Hose Adapter



LS1, LS2, LS3, LS6 Front Timing Cover



LS Front Distributor Drive Cover



Rear Block Cover

Block Completion Components

Part Number	Description	Technical Notes
19299099	Gen IV Block Completion Kit – Non D.O.D.	Complete your LSX or Gen IV production engine with production components; Includes 1 front engine cover, 1 valley cover, 4 head locator dowels, 1 crankshaft sensor, 1 crank sensor bolt, 1 timing chain damper
25534412	Oil Hose Adapters	Bolts directly to oil pan, and has AN male outlet for AN-12 fittings; Includes 1 adapter, 2 fittings, 2 bolts and 2 sealing gaskets

Gen III Bare Block Completion Components

Part Number	QTY	Description	Part Number	QTY	Description
12577927	1	Valley Cover	12560228	1	Crankshaft Sensor
19420911	1	Cam Sensor	12570326	4	Head Locating Dowels
12633906	1	Front Cover (with seal)	12595365	4	Lifter Guide
12720455	2	Transmission Alignment Dowel	12639250	1	Rear Cover (with seal)
12589016	1	Cam Retainer Plate	varies	–	Required Water and Oil Plugs
11561455	4	Cam Retainer Bolts	varies	–	Required Mounting Bolts
12588670	1	Timing Chain Damper			



Gen III Bare Block Completion Components

Front Covers

Part Number	Description	Technical Notes
12633906	LS1, LS2, LS3, LS6 Front Timing Cover	For LS1, LS2, LS3 and LS6 engines; Cover only; Does not come with cam sensor, bolts or seals
12594939	L92 Front Timing Cover (not shown)	For engines with VVT such as L92; Cover only; Does not come with cam sensor, bolts or seals
12598293	LS7 Front Timing Cover (not shown)	Also fits LS9 engines; Required for 2-stage oil pump clearance; Cover only; Does not come with cam sensor, bolts or seals
88958679	LS Front Distributor Drive Cover	Assembly is manufactured for applications where a 4-bbl carburetor and distributor are required; For all LS-Series engines except LS7 and LS9 NOTE: Distributor and mechanical fuel pump not included. Uses Small-Block Ford-style distributor and mechanical fuel pump. Special water pump, accessory drive and damper required.
12735382	Front Cover Gasket (not shown)	For all LS-Series engines
12585673	Front Crank Seal (not shown)	For all LS-Series engines
11515758	Front Cover Bolt (not shown)	Requires 8 per engine; For all LS-Series engines

Rear Covers

Part Number	Description	Technical Notes
12639250	Rear Block Cover	Includes seals and bolts; For all production LS engine blocks (will not work on LSX blocks)
19369274	LSX Rear Block Cover (not shown)	Does not include bolts or seals; For use on LSX blocks only
89060436	Rear Crank Seal (not shown)	For all LS-Series engines

BUILDER'S TIP

Building a Carbureted LS Engine

For some vintage cars, a carbureted induction system is aesthetically appropriate. Some racecars depend on a carburetor, because of class rules or other reasons. Building a carbureted LS engine is just as easy as assembling a production-style fuel injected version. You'll still need all the sensors of an injected engine, but you simply replace the injection manifold with one of the Chevrolet Performance carbureted intakes—they're available for LS1/LS2/LS6-style cathedral-port heads, L92/LS3-style heads and LS7 heads. Then, add your favorite four-barrel and plug it all into one of our pre-programmed controllers. Add a 12-volt power source and your carbureted LS engine will deliver a balanced combination of vintage looks and modern engine management dependability!



LS/LT/LSX-Series Cylinder Heads

QUICK REFERENCE CHART

Part Number	Description	Material	Port Vol (cc)	Valve Angle	Chbr (cc)	Int Vlv (in)	Exh Vlv (in)	Int Port Type	Exh Port Type	Rocker Mount	Notes	Page
12711770	Stock L92	Aluminum	260	15 deg	70	2.165	1.590	L92	Std LS	Bolt-down	Solid stem valves	93
12675871	Stock LS3	Aluminum	260	15 deg	68.4	2.165	1.590	L92	Std LS	Bolt-down	Hollow/solid	93
88958758	CNC LS3 (Disc.)	Aluminum	276	15 deg	68.5	2.165	1.590	L92	Std LS	Bolt-down	Hollow/solid	N/S
12578450	Bare LS7	Aluminum	270	12 deg	70	2.200	1.610	LS7	Std LS	Bolt-down	Bare LS7	N/S
12578449	Stock LS7 (Disc.)	Aluminum	270	12 deg	70	2.200	1.610	LS7	Std LS	Bolt-down	Titanium/sodium-filled valves	N/S
19328744	Bare LS9	Aluminum	276	15 deg	68.4	2.165	1.590	L92	Std LS	Bolt-down	Bare LS9	N/S
19433498	LS9 CNC Assembly	Aluminum	276	15 deg	68.4	2.165	1.590	L92	Std LS	Bolt-down	LS9 CNC Assembly	93
12626958	LSA (Disc.)	Aluminum	260	15 deg	68.4	2.165	1.590	L92	Std LS	Bolt-down	CTS-V and Z-28 assembly	N/S
19329839	LT1 CNC	Aluminum	313.9	Splayed	59.02	2.130	1.590	LT-1	LT-1	Bolt-down	CNC Runners	93
12699617	LT1	Aluminum	293.8	Splayed	59.02	2.130	1.590	LT-1	LT-1	Bolt-down	Corvette assembly	93
12699619	LT4 Assembly	Aluminum	293.8	12 deg	65.47	2.126	1.590	LT4	LT4	Bolt-down	Titanium int. valve	93
25534393	C5R	Aluminum	210	11 deg	38	2.180	1.630	C5R	Std LS	Shaft	As-cast, no seats/guides	93
19419187	LSX-LS3	Aluminum	260	15 deg	70	2.165	1.590	L92	Std LS	Bolt-down	Hollow/solid valves	94
19419193	LSX-LS7	Aluminum	270	12 deg	70	2.200	1.610	LS7	Std LS	Bolt-down	Titanium/sodium-filled valves	94
19419194	LSX-LS7 Bare	Aluminum	N/A	12 deg	70	2.200	1.610	LS7	LS7	Bolt-down	N/A, As-cast	94
19419196	LSX-LS7 Bare	Aluminum	270	12 deg	70	2.200	1.610	LS7	Std LS	Bolt-down	Fully CNC-machined	94
19419197	LSX-LS7 Assembly	Aluminum	270	12 deg	70	2.200	1.610	LS7	Std LS	Bolt-down	Fully CNC-machined	94
19417408	LSX-SC As-Cast	Aluminum	N/A	12 deg	68	2.200	1.610	LS7	LS7	Bolt-down	As-cast, not machined	95
19417887	LSX-SC CNC	Aluminum	N/A	12 deg	68	2.200	1.610	LS7	LS7	Bolt-down	Fully CNC-machined bare head	95
19417888	LSX-SC Assembly	Aluminum	N/A	12 deg	68	2.200	1.610	LS7	LS7	Bolt-down	Fully CNC-machined assembly	95

LS & LT PRODUCTION AND PERFORMANCE CYLINDER HEADS

Great cylinder-head airflow has been a key enabler of the LS and LT engine families' exceptional performance, and Chevrolet Performance's range of production-based and factory-engineered performance heads offers almost limitless options for building power. That includes CNC finishing and porting on some heads. Performance capability is elevated with our LSX heads, which are designed to support the airflow and durability needs of high-performance engines. That includes the capability of six-bolt head-clamping, when used with an LSX Bowtie Block, compared to the four-bolt design of production-based, non-LSX blocks.

NOTE: Chevrolet Performance heads will not fit 4.8L and 5.3L engines, due to their smaller bore sizes.

Aluminum LS Family Head Technical Notes:

- Manufactured from 319-T5 aluminum alloy
- High-efficiency combustion chambers
- Symmetrical intake and exhaust ports
- Angled spark plugs (14mm; 5/8" hex; 3/4" reach; taper-seat plugs)
- 15° valve angle (except C5R and LS7)
- Bolt-down-type rocker arms (except LSX-DR, LSX-CT)
- Center-bolt valve cover hold-downs
- Fits Gen III and Gen IV Small-Blocks only

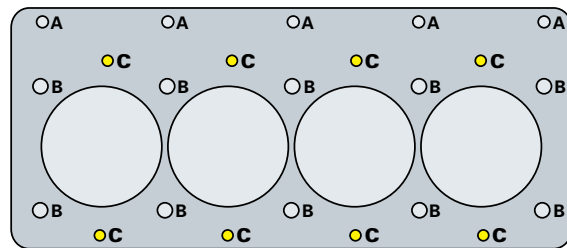

LS/LSX Head-Bolt Patterns

A	Standard LS	8mm	Bolt/Stud
B	Standard LS	11mm	Bolt/Stud
C	LSX	8mm	Bolt/Stud



Bare C5R Racing Cylinder Head (intake)



Bare C5R Racing Cubed Cylinder Head (exhaust)



Bare C5R Racing Cylinder Head (combustion chamber)



LS9 CNC-Ported Cylinder Head Assembly (intake)



LT1 CNC Cylinder Head Assembly (intake)



LS9 CNC-Ported Cylinder Head Assembly (exhaust)



LT1 CNC Cylinder Head Assembly (exhaust)



LS9 CNC-Ported Cylinder Head Assembly (combustion chamber)



LT1 CNC Cylinder Head Assembly (combustion chamber)

Part Number	Description	Technical Notes
12711770	L92 Cylinder Head Assembly (not shown)	Aluminum performance head; Fits any LS family engine with 4.000" bore or larger; 2.165" solid stem intake and 1.590" solid stem exhaust valves; .510" max valve lift; As-cast L92 style intake ports; D-shaped exhaust ports; As-cast combustion chambers
12675871	LS3 Cylinder Head Assembly (not shown)	Aluminum performance head; Fits any LS family engine with 4.000" bore or larger; 2.165" hollow stem intake and 1.590" solid stem exhaust valves; .550" max valve lift; As-cast L92 style intake ports; D-shaped exhaust ports; As-cast combustion chambers
19433498	LS9 CNC-Ported Cylinder Head Assembly w/LS3 Valves	CNC-ported version of the LS9 cylinder head; Flows about 10 percent more than the production head—more than 350 cfm (intake side) at .600" lift; 276cc intake runners and 92cc exhaust ports; Fits all LS engines with 4.000" bore or larger; 2.165" hollow stem intake and 1.590" solid stem exhaust valves; .550" max valve lift; D-shaped exhaust ports
12578449 (Discontinued)	LS7 CNC-Ported Cylinder Head Assembly (not shown)	356-T6 aluminum head; Fully CNC'd ports and chambers; LS7 rectangle port design; Assembled with 2.200" titanium intake and 1.610" sodium-filled exhaust valves; 12° valve angle; Minimum 4.100" bore; 270cc CNC'd intake ports, 85cc CNC'd exhaust ports; 70cc CNC'd combustion chambers; Capable of over 600 horsepower; Bare head P/N 12578450 available separately
25534393	Bare C5R Racing Cubed Cylinder Head	355-T7 "as-cast" aluminum racing head; Professional porting and machining of combustion chambers required; No seats or guide machining; C5R rectangle-port design—requires aftermarket rectangle-port intake manifolds; Designed for big bore (4.100" min) LS7/C5R/LSX blocks; 210cc "as-cast" intake ports; 70cc "as-cast" exhaust ports, same as production LS6; 30cc "as-cast" combustion chambers; All fasteners are metric; Capable of over 800 horsepower!; Standard LS exhaust port design
12699617	LT1 Cylinder Head Assembly (not shown)	Replacement for production cylinder head assembly; Fully assembled; Machined for direct fuel injection
19329839	LT1 CNC Cylinder Head Assembly	Fully assembled; Machined for direct fuel injection; CNC machine-ported intake and exhaust runners; Included in P/N 19333525 Head and Hot Cam Kit
12699619	LT4 Cylinder Head Assembly (not shown)	Rotocast A356-T6 aluminum casting used on the supercharged LT4; Rotocast manufacturing eliminates porosity; Machined for direct injection; Features larger chambers than LT1 head (65.47cc) for lower compression on supercharged applications; Assembled with 2.126" titanium intake valves and 1.590" sodium-filled exhaust valves; Valve springs designed for production LT4 camshaft; Not compatible with LT1 or L8T production intake manifolds.

LS-Series Cylinder Heads: Additional Required Components

Part Number	Gaskets (Quantity)	Bolts (Quantity)	Spark Plug	Engine Application
12711770	12610046 (2) OR 19170419	19258707 (20), 12558840 (10)	12680072	L9H
12675871	12610046 (2) OR 19170419	19258707 (20), 12558840 (10)	12680072	LS3
19433498	12610046 (2) OR 19170419	19258707 (20), 12558840 (10)	12680072	CNC LS9
12578449 (Discontinued)	12582179 (2) OR 19170419	19258707 (20), 12558840 (10)	12571165	MY06/07 LS7
19328743	12610046 (2) OR 19170419	19258707 (20), 12558840 (10)	12680072	LS9
25534393	12582179 (2) OR 19170419	19258707 (20), 12558840 (10)	12680072	C5R



Parts intended for competition use only. See page 2 for details.



Additional components required for installation. See chart above.



LSX CYLINDER HEADS



Extending the performance range of the LSX platform are Chevrolet Performance's 6-bolt LSX cylinder heads. Many are capable of flowing more than 400 cfm, and their 6-bolts-per-cylinder clamping design gives them exceptional strength. Your horsepower-building potential can be nearly unlimited with LSX heads.

These aluminum masterpieces of performance feature port and chamber designs based on popular and performance-proven production-style heads, such as the LS3/L92 and LS7 heads. They are easily identified by the engraved LSX logo on the ends.

All LSX heads are made of 356-T6 aluminum and feature a 1/8" thick deck that allows plenty of room for builder-specified combinations. Additional features include:

- Uses 11mm (10) and 8mm (13) head bolts (not included, see drawing on page 92)
- Accommodates production valvetrain components (except for drag race and circle track heads)
- Includes premium beehive-type valve springs (except for drag race and circle track heads)
- Extra material cast in the port areas to accommodate professional porting
- Valve guides for 8mm valve stems, except DR & CT

Racing-specific LSX-DR (drag racing) and LSX-CT (circle track) heads feature raised runner designs and other unique features designed to maximize performance at the track.

LSX Performance Cylinder Heads

Four LSX performance cylinder head configurations are offered: The LSX-LS7 head, the LSX-LS3 head, the LSX-LS9 head and the LSX-L92 Small Bore head. The LSX-L92 head features smaller combustion chambers that are compatible with smaller-bore LS1 and LS6 engines. The performance heads accommodate valve springs with up to 1.37" diameter bases, but can be machined for larger springs.



LSX-LS7 Cylinder Head Assembly (exhaust)



LSX-LS7 Cylinder Head Assembly (intake)



LSX-LS7 Cylinder Head Assembly (combustion chamber)

Part Number	Description	Technical Notes
19419187	LSX-LS3 Cylinder Head (not shown)	L92 style rectangle port design; Assembled with 2.165" hollow stem intake and 1.590" solid stem exhaust valves; 15° valve angle; minimum 4.000" bore; 260cc "as-cast" intake ports, 80cc "as-cast" exhaust ports; 70cc "as-cast" combustion chambers; Uses LS3 rocker arms/LS7 bolts
19419196	LSX-LS7 CNC-Ported Bare Cylinder Head (not shown)	Fully CNC ported; 6-bolt-per-cylinder bolt pattern; LS7-style rectangle port design; 12° valve angle; minimum 4.100" bore; 70cc "as-cast" combustion chambers; Uses LS7 rocker arms/LS7 bolts; 397 cfm@.700" intake, 230 cfm@.700" exhaust
19419197	LSX-LS7 CNC-Ported Cylinder Head Assembly (not shown)	Fully CNC ported; 6-bolt-per-cylinder bolt pattern; LS7-style rectangle port design; Assembled with 2.200" titanium intake and 1.610" sodium-filled exhaust valves; 12° valve angle; minimum 4.100" bore; 70cc "as-cast" combustion chambers; Handles .650" lift with premium springs; Uses LS7 rocker arms/LS7 bolts; Uses P/N 19419196 bare head (shown); 397 cfm@.700" intake, 230 cfm@.700" exhaust
19419193	LSX-LS7 Cylinder Head Assembly - As Cast	6-bolt-per-cylinder bolt pattern; LS7-style rectangle port design; Assembled with 2.200" titanium intake and 1.610" sodium-filled exhaust valves; 12° valve angle; minimum 4.100" bore; 270cc "as-cast" intake ports, 85cc "as-cast" exhaust ports; 70cc "as-cast" combustion chambers; Handles .650" lift with premium springs; Uses LS7 rocker arms/LS7 bolts
19419194	LSX-LS7 Bare Cylinder Head - As Cast (not shown)	Used in P/N 19419193
19419190	LSX-LS9 Cylinder Head Assembly (not shown)	L92-style rectangle port design; Assembled with 2.165" titanium intake and 1.590" sodium-filled exhaust valves; 15° valve angle; minimum 4.000" bore; 260cc "as-cast" intake ports, 80cc "as-cast" exhaust ports; 70cc "as-cast" combustion chambers; Uses LS3 rocker arms/LS7 bolts

LSX-SC Cylinder Heads

Chevrolet Performance's LSX-SC cylinder head is an enhanced version of the LSX head design and was developed for the COPO 350 Supercharged production engine. It is designed specifically for the higher cylinder pressures that come with high-boost forced induction applications.

The LSX-SC is based on the proven, high-flow LSX-LS7 design, but optimized in key areas to enhance strength and cylinder sealing for engines producing upwards of 1,400 horsepower. Like other LSX cylinder heads, it is made of tough T356 aluminum, but produced with a low-pressure casting process to improve density. Additionally, the head is treated with hot isostatic pressing—commonly known as "HIPing"—to optimize the aluminum alloy's mechanical properties and density.

Additionally, the head's water jacket has been reduced to shore up its strength, compared to the LSX-LS7 head, which leaves more room for builders to machine the ports separately.



LSX-SC Bare Cylinder Head – CNC Machined (exhaust)

The new LSX-SC head is offered in an unmachined, as-cast version (P/N 19417408) and a CNC-machined version with valve seats and guides installed (P/N 19417887). The CNC version is also available assembled with valves and beehive-type valve springs installed (P/N 19417888).

Additional details:

- LSX-signature six-bolts-per-cylinder head clamping
- LS7-style rectangular port design (use with LS7-compatible intake manifold)
- Combustion chamber volume: 68cc
- Intake port volume: 277cc
- Exhaust port volume: 99cc
- Same 12° valve angles as LSX-LS7 head
- Valve seats are 45° (intake) and 50° (exhaust)
- Valve pockets machined at 37mm-diameter (with sufficient room to machine larger)
- LSX-LS7 exhaust bolt pattern (use with LS7-compatible headers), but bolt holes are raised .100" for improved header/gasket centering
- Use with standard LSX-compatible head gaskets
- Designed for LS7 rocker arms and bolts, but can be machined for shaft-style rockers
- Designed for LSX 2.20" (intake) and 1.61" (exhaust) valves





LSX-SC Bare Cylinder Head – As-Cast (exhaust)



LSX-SC Bare Cylinder Head – As-Cast (intake)



LSX-SC Bare Cylinder Head – As-Cast (combustion chamber)

Part Number	Description	Technical Notes
19417408 	LSX-SC Bare Cylinder Head – As-Cast	Made of T356 aluminum with low-pressure casting and hot isostatic pressing for enhanced strength and material density; Unported casting with smaller water jackets to accommodate additional porting and machining; Valve seats and valve guides included, but delivered uninstalled
19417887 	LSX-SC Bare Cylinder Head – CNC-Machined	Made of T356 aluminum with low-pressure casting and hot isostatic pressing for enhanced strength and material density; CNC-machined intake and exhaust ports; CNC-machined combustion chambers; Includes valve seats and valve guides installed
19417888 	LSX-SC Assembled Cylinder Head – CNC-Machined (not shown)	Made of T356 aluminum with low-pressure casting and hot isostatic pressing for enhanced strength and material density; CNC-machined intake and exhaust ports; CNC-machined combustion chambers; Includes valve seats and valve guides installed ; Valve seats and guides designed to accommodate 2.20" (intake) and 1.61" (exhaust) valves; Assembled head includes 2.20" intake and 1.61" valves and beehive-type valve springs (including retainers and keepers) installed



LSX-SC Bare Cylinder Head – CNC Machined (intake)



LSX-SC Bare Cylinder Head – CNC Machined (combustion chamber)



CYLINDER HEAD GASKET AND BOLT KITS

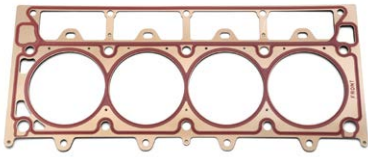

LS, LSX Head Gasket

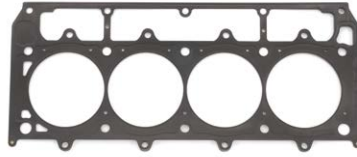

LSX 4.100" Bore MLS Head Gasket Kit

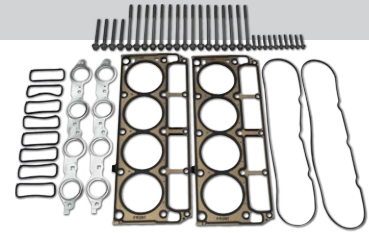

LS1 Cylinder Head Installation Kit (F-Car)

Part Number	Description	Technical Notes
12498544	Cylinder Head Gasket Kit (not shown)	2 head gaskets for 1997–2001 LS1 Camaro/Firebird and Corvette engines; Also fits 2001 LS6 Corvette engine
19170418	LSX 4.100 Bore MLS Head Gasket Kit	Multi-layer steel gaskets for naturally aspirated and forced induction applications; 0.051" thick; Includes 1 LH and 1 RH gasket; For standard LS and LSX 6-bolt pattern blocks and heads; For bores up to 4.100"
19170419	LSX 4.200 Bore MLS Head Gasket Kit (not shown)	Multi-layer steel gaskets for naturally aspirated and forced induction applications; 0.051" thick; Includes 1 LH and 1 RH gasket; For standard LS and LSX 6-bolt pattern blocks and heads; For bores up to 4.200"
19170420	LSX 4.250 Bore MLS Head Gasket Kit (not shown)	Multi-layer steel gaskets for naturally aspirated applications; 0.051" thick; Includes 1 LH and 1 RH gasket; For standard LS and LSX 6-bolt pattern blocks and heads; For bores up to 4.250"
12498545	Cylinder Head Bolt Kit (1997-2003, not shown)	Kit of 15 head bolts for 1998–2003 LS1 Camaro/Firebird 1997–2003 Corvette and 2001–2003 LS6 Corvette; 1 kit per cylinder head; Order 2 per engine; Head bolts cannot be reused on these engines NOTE: IMPORTANT! LS-Series engines produced from January 2004 forward have a new "short-style" head bolt design. Earlier head bolts will not fit. Order P/N 17800568 for engines produced from January 2004 and later.
17800568	Cylinder Head Bolt Kit, Gen III and Gen IV (not shown)	Kit of 15 bolts for LS-Series engines produced from January 2004 and later; Bolts are 5mm shorter than previous design; Services single engine head only
19257453	Cylinder Head Bolt Kit – Std. Deck LSX Block (not shown)	Contains additional bolts for standard-deck LSX 6-bolt heads. Contains bolts for 2 heads (1 engine) NOTE: Engine set requires 2 - 17800568 bolt sets for conventional Gen III & Gen IV engines. For complete LSX set, order: 2 - 17800568 - Gen III & Gen IV bolt kits, 1 - 19257453 - LSX Standard Deck Bolt Kit.
19257452	Cylinder Head Bolt Kit – Tall Deck LSX Block (not shown)	Contains additional bolts for tall-deck LSX 6-bolt heads; Contains bolts for 2 heads (1 engine) NOTE: Engine set requires 2 - 17800568 bolt sets for conventional Gen III & Gen IV engines. For complete LSX set, order: 2 - 17800568 - Gen III & Gen IV bolt kits, 1 - 19257452 - LSX Tall Deck Bolt Kit.
12499217	LS1 Cylinder Head Installation Kit (F-Car)	Comprehensive cylinder head installation kit for 2002 Camaro and Firebird models equipped with the LS1 engine. Kit includes 2 head gaskets, 2 valve cover gaskets, 8 intake manifold gaskets, 2 exhaust manifold gaskets, 2 intake manifold-to-block seals, 20 long-head bolts and 10 short-head bolts
12589226	LS1/LS6 Head Gasket (not shown)	Single gasket, 2 required; For naturally aspirated LS1 and LS6 5.7L engines; 0.051" thick; 3.920" max bore; Standard LS bolt pattern
12589227	LS2, L76 Head Gasket (not shown)	Single gasket, 2 required; For naturally aspirated LS2 and L76 6.0L engines; 0.051" thick; 4.020" max bore; Standard LS bolt pattern
12610046	LS3, L92 Head Gasket (not shown)	Single gasket, 2 required; For naturally aspirated LS3/L92 6.2L engines; 0.051" thick; 4.080" max bore; Standard LS bolt pattern
12582179	LS7 Head Gasket (not shown)	Single gasket, 2 required; For naturally aspirated LS7 7.0L engines; 0.051" thick; 4.140" max bore; Standard LS bolt pattern
19331526	LT1, LT4, LT5 Head Bolt Gasket Kit (not shown)	Head bolts and head gaskets for Gen V engine
19418279	LT1, LT4, LT5 Head Bolt Kit (not shown)	Head bolts set for one Gen V engine
19419249	LS, LSX Head Gasket (single)	Special head gasket for COPO supercharged engine - requires 2

BUILDER'S TIP

Tiered performance cylinder head strategy delivers options

Cylinder head selection is one of the most important contributors to an engine's performance, because it ultimately determines how much air the engine can process to generate horsepower. The heads for regular-production LS- and LT-family engines are renowned for exceptional airflow attributes and offer significant power-building capability with traditional machining that enhances the volume of the intake ports and/or reduces restriction within the ports.

Chevrolet Performance's tiered strategy for LS cylinder head performance offers builders choices to fit a variety of performance goals and budgets. The first tier is our production-based heads, such as the LS3 head (P/N 12675871), which offer good out-of-box performance and are an excellent upgrade for earlier LS engines (as long as they have at least a 4.000" bore). The next tier is ported production heads, such as the LT1 CNC-ported head (P/N 19329839), which deliver significantly greater intake-port airflow at a value-driven cost.

For production-based engines using forced induction—supercharging or turbocharging—the LS9 CNC-ported heads are the ultimate solution, delivering greater strength and heat management properties through a unique production process with the A356-T6 alloy.

The top tier of Chevrolet Performance's cylinder head ladder is the maximum-performance LSX heads, which are based on the design of production heads but include strength-enhancing features, such as thicker decks, to support high-horsepower performance combinations. They also have a six-bolts-per-cylinder design vs. the four-bolt design of production LS heads, for exceptional clamping strength with supercharging, turbocharging and nitrous oxide. The six-bolt heads must be used with Chevrolet Performance LSX Bowtie cylinder blocks.

With Chevrolet Performance cylinder heads, there's a choice for every horsepower aspiration and budget.





ROCKER ARMS AND ROCKER ARM BOLTS

Part Number	Description	Technical Notes
12681275	Rocker Arm (not shown)	For LS1, LS2 and LS6 intake and exhaust valves; For L92, LS9 and LS3 exhaust valves; Straight design, no offset; 1.7:1 ratio
12696105	Rocker Arm (not shown)	Intake rockers for L92, LS9 and LS3 style heads only; Offset design; 1.7:1 ratio
12579615	Rocker Arm (not shown)	Intake rockers for LS7 style heads only; Offset design; 1.8:1 ratio
12579617	Rocker Arm (not shown)	Exhaust rockers for LS7 style heads only; Straight design, no offset; 1.8:1 ratio
12560961	Rocker Arm Bolts (not shown)	For cathedral port and L92 style heads; 16 required per engine
11588791	Rocker Arm Bolts (not shown)	For LS7 & LSX style heads; 16 required per engine
12552203	Rocker Arm Stand (not shown)	For LS1, LS2 and LS6 style heads only; Sold individually; Requires 1 per cylinder head
12600936	Rocker Arm Stand (not shown)	For L92, LS9 and LS3 style heads only; Sold individually; Requires 1 per cylinder head
19201808	LSX454R Rocker Arm Kit (not shown)	1.9:1 ratio; Fits DR head only; Full-roller bearing tips; Full-roller bearing trunnion; Set is for two heads; Requires special valve cover for clearance





LS-SERIES PUSHRODS

Part Number	Material	Diameter	Length	Usage	Description
12593344	1010 steel	3/8"	7.750	LS7	Production pushrod, individually packed
10238852	1010 steel	5/16"	7.325	LS1, LS2, LS3, LS6, L92	Production pushrod, individually packed





LS-SERIES INTAKE VALVES

Part Number	Valve Size	Stem Size	Description
12617533 	2.165"	8mm	Stock replacement valve used in L92 engines
12605223 	2.165"	8mm	Stock replacement solid-stem valve used in LSA engines
12569427 	2.165"	8mm	Stock replacement hollow-stem valve used in LS3 engines
12605524 	2.165"	8mm	Stock replacement titanium valve used in LS9 engines
12591644 	2.200"	8mm	Stock replacement titanium valve used in LS7 engines

LS-SERIES EXHAUST VALVES

Part Number	Valve Size	Stem Size	Description
12694167 	1.500"	8mm	Stock replacement solid-stem valve used in LS2 engines
12582719 	1.590"	8mm	Stock replacement solid-stem valve used in L92 and LS3 engines
12605525 	1.590"	8mm	Stock replacement sodium-filled stem valve used in LS9 engines
12618110 	1.610"	8mm	Stock replacement sodium-filled stem valve used in LS7 engines

VALVE SPRINGS AND SPRING KITS

Part Number	Description	Technical Notes
19420455 	LS Valve Spring Kit (not shown)	Beehive style springs; Used on LS3, LS2/LS6 cylinder heads; Installed height—1.800" @ 90 lbs. pressure; Max lift .550"; 1.250" @ 295 lbs. pressure; Includes 16 of P/N 12713265
12713265 	Valve Springs (not shown)	Beehive style springs; Standard LS6/LS3 springs; Use cap P/N 10166344; 1.250" @ 295 lbs. pressure; Installed height—1.800" @ 90 lbs. pressure; Max lift—.550"
12706568 	Valve Springs (not shown)	Beehive style springs; Standard L76/L92 springs; Installed height—1.800" @ 90 lbs. pressure; Max lift—.520"; 1.300" @ 264 lbs. pressure
12621428 	Valve Springs (not shown)	Beehive style springs; Used on LS7 cylinder heads; Installed height—1.960" @ 101 lbs. pressure; 1.368" @ 310 lbs. pressure; Max lift—.600"



Parts intended for competition use only.
See page 2 for details.



Performance

97

LS-SERIES VALVE COVERS

Nothing finishes off your engine like a great-looking set of valve covers straight from GM. Our new collection of LS valve covers allows you to personalize your LS-powered project with a custom look. Choose from 8 great styles, available in natural, powder-coated, polished and chrome finishes, with callouts for your favorite nameplate, vehicle and more. These valve covers are designed and built to production specs and include a production-type O-ring gasket for a leak-free fit. No matter if you're driving a new Corvette or a Pro-Touring-style, LS3-powered '61 Chevy, we've got the perfect set of valve covers for it.

NOTE: The valve covers feature the standard bolt pattern, but **DO NOT** have provisions for production-style coil mounts. Aftermarket or custom coil relocation brackets must be used. Additional features include:

- PCV system (except P/N 25534398 and P/N 25534399)
- Sold in pairs (except P/N 25534398 and P/N 25534399)
- Integrated oil fill
- Accommodates tall-style rockers
- Includes hardware and O-ring gasket



Valve Cover Kit – Chevrolet, Chrome

Part Number	Description	Technical Notes
19156433	Valve Cover Kit – CHEVROLET, Chrome	Chrome finish with black CHEVROLET lettering
19171497	Valve Cover Kit – LSX454	Black finish with red LSX logo
19171502	Valve Cover Kit – Polished	Polished finish with no logos
19171270	LSX376	Gray/Black; Used on LSX376-B8 engine
19332317	LSX376	Orange/Black; Used on LSX376-B15 engine
19332313	LSX454	Orange/Black; Used on LSX454 engine
19259058	LSX454R (not shown)	Orange/Black; Used on LSX454R engine
25534398	LS Center-Bolt Competition Valve Cover (with breather hole)	Lightweight aluminum valve cover designed for production center-bolt LS-Series cylinder heads; Includes bolts and seal; Sold individually; Natural finish
25534399	LS Center-Bolt Competition Valve Cover	Lightweight aluminum valve cover designed for production center-bolt LS-Series cylinder heads; Includes bolts and seal; Sold individually; Natural finish



Valve Cover Kit – LSX454



Valve Cover Kit – Polished



Valve Cover Kit – LSX376, Gray/Black



Valve Cover Kit – LSX376, Orange/Black



Valve Cover Kit – LSX454, Orange/Black



LS Center-Bolt Competition Valve Cover

LS Center-Bolt Competition Valve Cover (with breather hole)

HARDWARE

Part Number	Description	Technical Notes
12341993	Push-In Oil Filler Cap	Round oil filler cap with Bowtie logo for valve covers with 1.220" diameter hole
12573338	Oil Fill Cap	Production / For LS1 engines
12573337	Oil Fill Cap	Production / For L92 engines
12643759	Oil Fill Cap	Production / For LS3 engines
12577215	Valve Cover Bolt	Requires 4 per valve cover / For L92 engines

VALVE LIFTERS AND COMPONENTS

Part Number	Description	Technical Notes
12499225	LS-Series Camshaft Lifter Kit (not shown)	Set of 16 lifters for LS-Series engines; Same lifter used in LS2 and LS7 P/N 17122490 (single lifter)
12595365	Lifter Guide (not shown)	Works in Gen III and IV applications (except with AFM)

88958689 

Racing Hydraulic Roller Lifter Kit

If your Gen III or Gen IV application calls for sustained high-rpm's, this Racing Hydraulic Roller Lifter Kit is a must. It features reduced mass internal componentry for higher limiting speeds and to accommodate aggressive camshaft designs. Improved valvetrain dynamics and stability deliver more horsepower and better high-rpm performance—tested to 8,000 rpm! Set includes 16 lifters.



POWER UPGRADE KITS

19333525 

LT1 Head/Hot Cam Kit





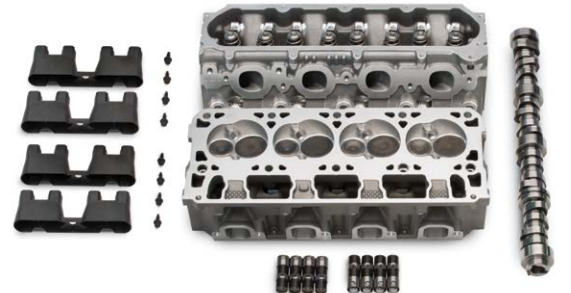







Increase your already-strong LT1 with these CNC–ported heads and camshaft designed specifically for direct injection. This is the first “Hot Cam” for the Gen V LT1. Kit includes camshaft (1), valve lifter guides (4), valve lifters (8), CNC cylinder head assemblies (2).

NOTE: Installation of this kit will affect engine variable valve timing and Active Fuel Management operation. Recalibration is required for accurate engine operation(not available from GM).



LS/LT-SERIES CAMSHAFTS

All OHV LS and LT camshafts are compatible with production-style LS/LT, LSX and C5R blocks, as well as all of our cylinder heads—although piston-to-valve clearance must be checked on some applications. We offer a broad range of production and racing-style camshafts that are factory-engineered to deliver maximum performance when paired with our high-flow cylinder heads. Save yourself the time and expense of going to an aftermarket camshaft supplier and build your LS/LT engine with a genuine GM cam. We've also got the valvetrain components you need to finish the engine, including lightweight components designed for high-rpm performance.

Part Number	Description	Duration @ .050" Lift (deg)	Maximum Lift (in) w/1.7 rocker**	Lobe Separation (deg)	Technical Notes
12565308 	2002–2004 LS6 Cam	I: 204 / E: 218	I: .550 / E: .550	117.5	Cam requires valve spring P/N 12713265
88958770 	ASA Cam	I: 226 / E: 236	I: .525 / E: .525	110	Cam requires valve spring P/N 12713265; "ASA" cam for off-highway use
19355738 	Hot Cam Kit	I: 219 / E: 228	I: .525 / E: .525	112	Kit includes 16 LS6 valve springs retainers
88958753 	LS Hot Cam	I: 219 / E: 228	I: .525 / E: .525	112	Same cam as in kit P/N 19355738
19166972 	LSX454 Cam (shown)	I: 236 / E: 246	I: .612 / E: .612	110	Max lift with 1.8 rockers .648/.648, 3-bolt design; NOTE: Not compatible with production-style variable-valve timing configurations or production valve springs.
88958766 	Showroom Stock Cam	I: 239 / E: 251	I: .570 / E: .570	106.5	Showroom Stock racing design; Requires hollow-stem intake valves P/N 12565311, hollow-stem exhaust valves P/N 12565312, valve springs P/N 12713265, and aftermarket notched pistons OR machined stock pistons
12638426 	LS7	I: 211 / E: 230	I: .558 / E: .558	121	Stock LS7 camshaft, will not work on Gen III engines; Max lift with 1.8 rockers .593/.588
12561721 	LQ9: 2002–2006 LS1: 2001–2004	I: 196 / E: 201	I: .467 / E: .479	116	Stock cam for 2002–2006 LQ9 and 2001–2004 LS1 engines
88958772 	LS Stage 2 Cam	I: 227 / E: 239	I: .551 / E: .551	108	Max lift with 1.8 rockers .583/.583
88958773 	LS Stage 3 Cam	I: 233 / E: 276	I: .595 / E: .595	107	Max lift with 1.8 rockers .630/.630
12623064 	LSA Cam	I: 198 / E: 216	I: .480 / E: .480	122.5	Stock LSA Cam
12638427 	LS9 Cam	I: 211 / E: 230	I: .562 / E: .562	122.5	Stock LS9 Cam
19303897 	LT1 Hot Cam	I: 228 / E: 248	I: .577 / E: .577	116.5	Design for 1.81:1 rocker arms; Requires non-afm lifters (See warranty statement on page 222.)

**Except where otherwise noted in Technical Notes.



LS CONNECTING RODS & COMPONENTS



1997-2004 Connecting Rod

Part Number	Description	Technical Notes
12568734	1997-2004 Connecting Rod	Connecting rod for use on all 1997-2004 production Corvettes and 1998-2002 Camaro/Firebirds with LS1/LS6; Press fit design; 6.098" C-C length; Sold individually
12649190	Connecting Rod (not shown)	Connecting rod used in 2005-2007 LS2 and 2008-2012 LS3 engines; Has bronze bushing; 6.098" C-C length; Sold individually
11610158	LS6 Rod Bolts (not shown)	Recommended for use in performance Gen III engines; Bolts have greater strength than pre-2000 rod bolts; 1 bolt per package; Order 2 per connecting rod
89017573	Rod Bearing (not shown)	1 required per connecting rod; For all LS-Series engines, except LS7 and LS9
89017811	LS7 Rod Bearing (not shown)	1 required per connecting rod; For LS7 and LS9 engines only

Main Bearings – LS Engines (not shown)

Part Number	Position	Per Engine	Description
89017877	1, 2, 4, 5	4	LS7 or LS9
89017808	3 (thrust)	1	LS7 or LS9
89017571	1, 2, 4, 5	4	Non-LS7 or LS9
89017572	3 (thrust)	1	Non-LS7 or LS9

LSX CONNECTING RODS

Like our new crankshafts, the new LSX connecting rods from Chevrolet Performance are made of high-strength, 4340 forged steel to deliver worry-free performance for your high-horsepower, high-revving LS engine. Additional strength comes in the rod's I-beam design. It's chamfered big end fits great with filleted cranks, like our LSX crankshafts.

19166964 🏆

LSX Connecting Rod Kit – 6.000"

- 2.100" journals (big end)
- .866" bushed small ends
- MUST be used with LSX forged pistons—not compatible with production pistons
- Includes 3/16" 12-point, SAE 8740 rod bolts
- Caps are dowel located
- Weight-matched, sold in sets of 8



19259254 🏆

LSX454 Rotating Assembly

Build your own "LSX Stroker" with this rotating assembly used in our powerful LSX454 crate engine. Order LSX fully machined block P/N 19417353 to build your own engine. Includes 4340 forged steel crankshaft with 8-bolt flange (45.125"), 8 connecting rods (4340 forged steel), and 8 forged aluminum pistons with coated skirts (4.185" Bore)

NOTE: Also includes performance piston rings, rod and main bearings (not shown).



LSX PISTONS

Complete your all-LSX rotating assembly with LSX forged-aluminum pistons from Chevrolet Performance. They're lightweight and tough, enabling higher revs and dependable performance, even with high-boost and nitrous-assisted applications. They're made of 4032 forged aluminum and available in 4.065" and 4.185" bores. Additional details include:

- Flat-top or dished designs with valve relief cut-outs
- High-tech skirt coating
- Forced pin oiling
- Pistons come with wrist pins and rings



LSX376 Piston (dished) – 4.065" bore



LSX454 Piston – 4.185" bore

Part Number	Description	Technical Notes
19244016	LSX376 Piston – 4.065" bore	14cc dish that lowers compression to approx. 9:1 (with most standard LS cylinder heads); Optimized for supercharged and turbocharged combinations; Use with stock-type connecting rods only
19166958	LSX454 Piston – 4.185" bore	Forged dished piston with valve reliefs; Must be used with LSX rods; Lightweight, includes rings and wrist pins; 4.185" bore, .866" wrist pin size; 1.2mm compression ring lands and a 2.0mm oil control ring land. NOTE: Not compatible with production-style LS connecting rods; Must be used only with new LSX connecting rods with .866" wrist pin bores.

LS-SERIES PISTONS AND PISTON RINGS

Premium-quality hypereutectic aluminum alloy pistons are used on most production LS engines (the LS9 supercharged uses forged aluminum). They are lightweight, durable and promote quieter operation. Chevrolet Performance offers production and oversized pistons for many applications. They're sold individually, unless otherwise specified. Check the accompanying chart for part numbers, specs, sizes and applications.



LS3 CT525 Forged Piston

LS-Series Pistons

Part Number	Engine Size	Bore Size	Oversize	Rod Length	Pin Type	Comp Ratio	With Chamber	Description
88984245	5.7L	3.898"	–	Standard	Pressed	–	65	Hypereutectic LS1 and LS6 replacement
88984246	5.7L	3.898"	+010"	Standard	Pressed	–	65	Hypereutectic LS1 and LS6 replacement
19178305	6.0L	4.000"	–	Standard	Floated	10.9	65	Hypereutectic LS2 and LQ9 replacement
89017479	6.0L	4.000"	+020"	6.098"	Floated	10.9	65	Hypereutectic LS2 and LQ9 replacement
19418214	6.2L	4.065"	–	Standard	Floated	10.7	65	Forged LS3 replacement

LS-Series Rings

Part Number	Bore Size	Oversize	Ring Thickness	Description
89017484	4.000"	–	1.2, 1.5, 2.5mm	Production ring pack for '05-'06 LS2, '06 L76
88894243	4.000"	–	1.5, 1.5, 3.0mm	Production ring pack for '05-'06 LQ9
12735470	4.065"	–	1.2, 1.2, 2.5mm	Production ring pack for LT4
89017776	4.125"	–	1.2, 1.2, 2.0mm	Production ring pack for '06 LS7
89017777	4.125"	+020"	1.2, 1.2, 2.0mm	Oversize LS7 ring pack



LS CRANKSHAFTS AND COMPONENTS

Our LS crankshafts are strong, precision-machined components that will support your high-horsepower aspirations. Choose from our nodular cranks up to 3.622-inch-stroke and our premium, forged-steel 4.125-inch-stroke crankshafts for larger-displacement combinations –and don't forget the proper reluctor wheel!



Crankshaft Assembly 1997–2004



Reluctor Wheel, 24x

Part Number	Description	Technical Notes
12736808	LS2 Crankshaft Assembly	Nodular cast 3.622" stroke crankshaft assembly has 58x reluctor wheel installed; Used on 2006–2007 Corvettes; Balanced for 4.000" bore engines
89060436	Rear Crank Seal	Requires 1 per engine; For all LS-Series engines
12557583	Roller Pilot Bearing	Used in high-performance manual transmission applications; Use when input shaft protrudes 3–6mm (.079–.112") beyond bell housing
14061685	Roller Pilot Bearing	Used in high-performance manual transmission applications; Use when input shaft protrudes 23–24mm (.906–.945") beyond bell housing
12611649	LS7 Forged Steel Crankshaft	Forged 4" stroke crankshaft for LS7 engine; Includes 58x reluctor wheel; Rebalancing required if LS7 rods and pistons are not used; Machine .886" from snout for use in wet sump applications
12559353	Reluctor Wheel, 24x (shown)	24-tooth crankshaft position sensor timing wheel for 1997–2005 engines
12736806	Reluctor Wheel, 58x	58-tooth crankshaft position sensor timing wheel for 2006 and newer engine
12641691	LSA Crankshaft (Discontinued)	Forged 3.622" stroke; 8-bolt flexplate/flywheel pattern
12710954	Gen V LT1 (Wet Sump) Crankshaft	Forged 3.622" stroke; 8-bolt flywheel pattern
12712984	Gen V LT4 (Wet Sump) Crankshaft	Forged 3.622" stroke; 8-bolt flywheel pattern

LSX CRANKSHAFTS AND COMPONENTS

Chevrolet Performance LSX crankshafts are made from 4340 forged steel (most production LS cranks are cast) and have generous fillets. Our LSX forged crankshafts deliver exceptional strength and durability when you're building an engine for the track. Additional features include:

- 2.100" rod journals
- 8-bolt flexplate/flywheel pattern
- Comes with 58x reluctor wheel
- Reluctor wheel can be swapped for use with LS1/LS2/LS6 controller
- Designed for internal balancing (must be balanced prior to use in engine)
- Requires the use of chamfered rods (see our LSX connecting rod selection)

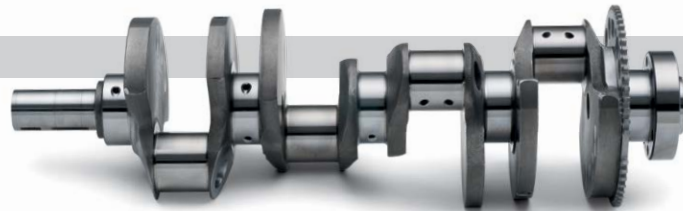

LSX Crankshaft, 4.125" stroke

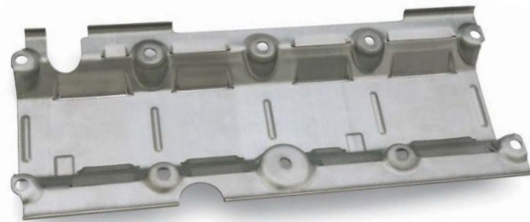

LSX Windage Tray Kit, for 4.125" stroke

Part Number	Description	Technical Notes
19244018	LSX Crankshaft, 4.125" stroke	4340 premium steel; 4.125" stroke; Requires balancing; Includes 58x reluctor wheel; 8-bolt flexplate/flywheel required
19244049	LSX Windage Tray Kit (not shown)	For 4.000" strokes; Includes all matching hardware; Some notching may be required
19202609	LSX Windage Tray Kit	For 4.125" strokes; Includes all matching hardware; Some notching may be required depending on application

FLYWHEELS AND FLEXPATES

At the opposite end of the crankshaft from the balancer are flywheels and flexplates, which connect the engine to either manual (flywheels) or automatic (flexplates) transmissions. Chevrolet Performance offers both internally and externally balanced flywheels and flexplates. It is critical you use the correct design for your engine application.

NOTE: For Transmission Installation kits, see pages 25–31



LS Engine Flywheels

Part Number	Year of Engine	Outside Diameter	Crank Flange Bolt Pattern	Converter Bolt Pattern Diameter	Starter Ring Gear Teeth	Technical Notes
12571611	1997–up	14" (359mm)	6-bolt LS pattern 3.110" (79mm)	11.5" Single Disc	168	Flywheel used for LS engines with 6-bolt crankshaft flange
24240678	2009–up	14"	8-bolt	9.5" Dual Disc	168	LSA Production Dual Mass with 8-bolt crankshaft flange (also fits LSX454)
12598613	2009–up	14"	9-bolt	10" Dual Disc	168	LS9 Production with 9-bolt crankshaft flange

LS Engine Flexplates

Part Number	Year of Engine	Outside Diameter	Crank Flange Bolt Pattern	Converter Bolt Pattern Diameter	Starter Ring Gear Teeth	Technical Notes
12654640	1997–up	14"	6-bolt LS pattern 3.110" (79mm)	11.062" (281mm)	168	Flexplate used for LS engines – fits stock LS-4L60 family torque converter
19260102	1997–up	14"	6-bolt LS pattern 3.110" (79mm)	11.5" (292.1mm)	168	Flexplate only used together with Spacer 12563532 and Bolts 19257940 (4L80 family)
12636325	2009–up	14"	8-bolt	11.062" (281mm)	168	LSA Production Flexplate (also fits LSX-454)
19125691	2009–up	14"	8-bolt	11.5" (291.1mm)	168	Modified LSA 12636325 Flexplate (see above) for use in Flywheel Kit 19125597
12620099	2014–up	14"	8-bolt LS/LT pattern	11.062" (281mm)	168	Production Gen V truck flexplate

TIMING CHAINS AND SPROCKETS

Part Number	Description	Technical Notes
12588670	LS2 Timing Chain Damper (not shown)	Production LS2 damper; Will not fit LS1 and LS6 blocks fitted with P/N 88958607 (P/N 88958607 is no longer serviced); For use with standard oil pumps
12581276	Timing Chain Damper (not shown)	Production LS7 damper; 1.1mm thinner than P/N 12588670; For use with LS7 2-stage oil pump
12576407	1X Camshaft Sprocket (not shown)	Fits all LS cams with 3-bolt design; 1X camshaft gear; 3-bolt design; Uses 3 bolts P/N 12556127
12586481	Camshaft Sprocket (not shown)	Fits all LS cams with 3-bolt design; 4X camshaft gear; 3-bolt design; Uses 3 bolts P/N 12556127
12585994	VVT Camshaft Sprocket (not shown)	Combination camshaft sprocket and VVT activator; Production on 2007–2008 Cadillac Escalade L92 engines; Single-bolt design; Use bolt P/N 12682000; 4X camshaft gear
12556582	Crankshaft Sprocket (not shown)	Fits non-LS7/LS9 applications; For standard single-stage oil pumps; Works with both cam sprockets P/N 12576407 and 12586481
12581278	Crankshaft Sprocket (not shown)	For use with 2-stage LS7 or LS9 oil pump only; Works with cam sprockets P/N 12576407 and P/N 12586481
12646387	Timing Chain (not shown)	Fits 1997–2009 LS-based engines
12626407	Timing Chain Tensioner (not shown)	Requires 1 per engine; Includes retainer and bolts; For L92 and LS3 engines
12556127	Camshaft Sprocket Bolt (not shown)	For use with 3-bolt (non-VVT) cams; For LS1, LS2, LS6, LS9 and early LS7 engines
11561283	Camshaft Sprocket Bolt (not shown)	For use with single-bolt cams and non-VVT timing covers; For 2008–2009 LS3 and LS7 engines
12682000	Camshaft Sprocket Bolt (not shown)	Combination bolt and valve for Variable Valve Timing (VVT) engines; For L92 engines; Use with VVT camshaft sprocket P/N 12585994

BOLTS, DOWELS AND BEARINGS

Part Number	Description	Technical Notes
11569956	Flywheel Bolt (not shown)	Requires 6 per engine; For LS1, LS2, LS3, LS6, LS7 and L92 engines; Use for both automatic flexplates and manual flywheels
11505820	Flywheel Dowel (not shown)	For all LS-Series engines; Locating dowel pin for pressure plate
12561465	Pressure Plate Bolts (not shown)	6 pieces; 6 needed per flywheel; Used on all GM LS engine manual flywheels
14061685	Pilot Bearing (not shown)	Use with manual transmissions if the input shaft extends beyond the bell housing more than 20mm
12557583	Pilot Bearing (not shown)	Use with manual transmissions if the input shaft extends beyond the bell housing 5mm or less (or recessed slightly)

ACCESSORY DRIVE SYSTEMS

The easiest and most convenient way to finish your LS engine and get it ready to run in your vehicle is with one of our serpentine accessory drive systems. They include the accessories, brackets, drive belts and hardware your engine needs, saving you the time of sourcing them individually. They're all-inclusive systems that bolt right onto the engine for a factory fit and appearance.

19421445

Corvette Accessory Drive System – without A/C

- Fits all non-LSA and LS9 LS-type engines
- Most harmonic balancers do not line up correctly with the accessory drive system; damper P/N 12674582 is strongly recommended
- Direct bolt-on for LS3 & LS7 engines

NOTE: Use on LS327 iron block engine requires harmonic balancer P/N 12674582.

NOTE: Water pump P/N 12710208 NOT included with kit.

NOTE: Will not work with cam-phased engine.

19419286

Corvette Accessory Drive System – A/C Add-on

Components needed to add A/C to your LS-equipped vehicle.

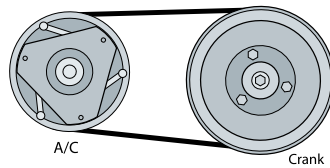

- Kit includes mounting bracket, bolts, belt, A/C compressor and instruction sheet
- Intended to be used in conjunction with P/N 19421445 GMPP kit for non-A/C applications
- Not verified to work with any non-GM FEAD kit
- Includes variable displacement compressor

19421444

Corvette Accessory Drive System – with A/C

Includes all components in kits P/N 19421445 and P/N 19419286.

- Fits all non-LSA and LS9 LS-type engines
- Most harmonic balancers do not line up correctly with the accessory drive system; damper P/N 12674582 is strongly recommended
- Air conditioning has separate belt; to delete air conditioning, do not install the belt, compressor or tensioner
- Direct bolt-on for LS3 & LS7 engines

NOTE: Use on LS327 iron block engine requires harmonic balancer P/N 12674582

NOTE: Water pump P/N 12710208 NOT included with kit.

NOTE: Will not work with cam-phased engine.

19368946

LSA Accessory Drive System – without A/C

The front engine assembly dress components used in the CTS-V, without A/C for installations in other vehicles.

- Includes all brackets, bolts, tensioners, pulleys, belts, alternator, P/S pump and instruction sheet

19244106

LSA Accessory Drive System A/C Add-On Kit (not shown)

Components needed to add A/C to your LSA-equipped vehicle.

- Kit includes mounting bracket, bolts, belt, A/C compressor and instruction sheet
- Intended to be used in conjunction with P/N 19368946 kit for non-A/C applications.
- Not verified to work with any non-GM FEAD kit

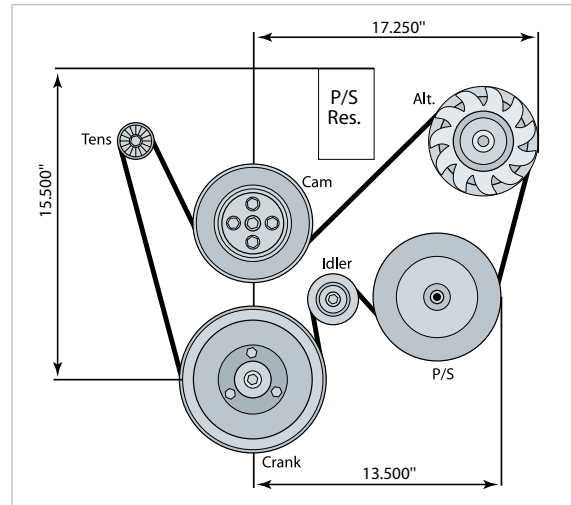

Corvette Accessory Drive System – without A/C

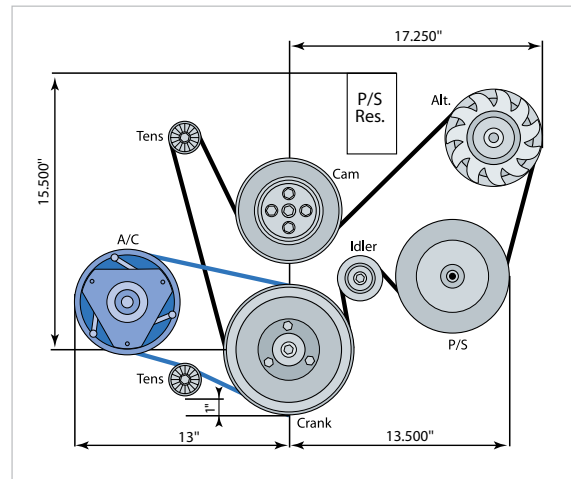

Corvette Accessory Drive System – with A/C

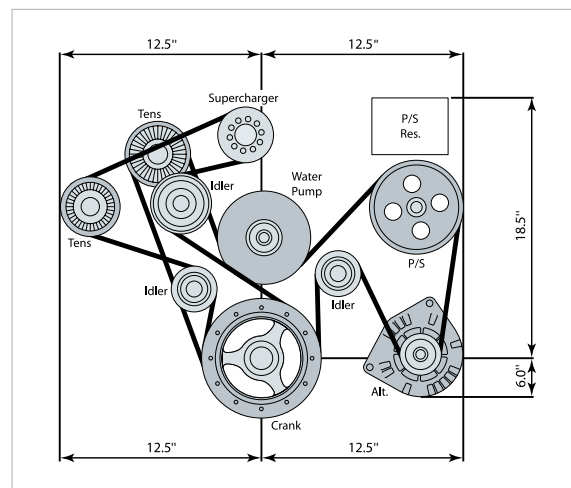

LSA Accessory Drive System – without A/C

19421442

Modified LSA Accessory Drive System – without A/C

Similar to LSA Accessory Drive Kit P/N 19368946, but designed for retro-fit applications with a relocated alternator and power steering pump to provide chassis clearance in older vehicles.

- Includes power steering pump and 2 remote-mount reservoirs; builder to use the reservoir that provides the best fit for the application
- Requires fabrication of reservoir mounting bracket
- Requires reservoir-to-pump hose
- Can be used with either LSA A/C add-on or Corvette A/C add-on kit

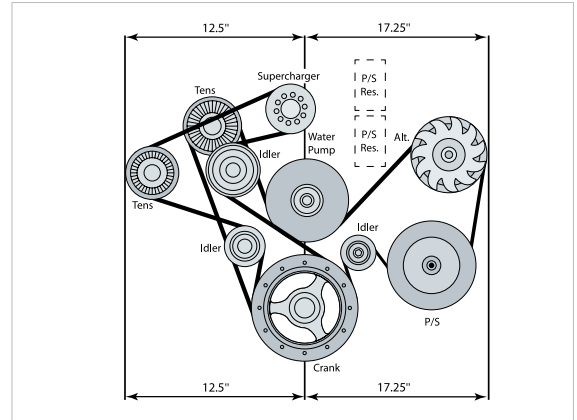

Modified LSA Accessory Drive System – without A/C

19369108

LC9 5.3L Accessory Drive System – without A/C

The workhorse LC9 5.3L engine assemblies come with an alternator bracket attached. These components are engineered for heavy-duty work-truck use and will provide years of reliable service in your performance vehicle.

Power Steering Pump Pulley Install Tool (included)

NOTE: This kit is designed to include the necessary parts to install the complete kit on a Chevrolet Performance 5.3L Crate Engine. If you do not have a Chevrolet Performance 5.3L Crate Engine, you may need some additional hardware. See your dealer or visit chevroletperformance.com for details.

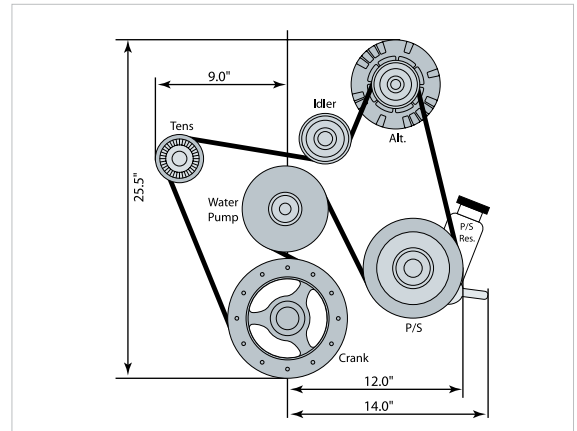

LC9 5.3L Accessory Drive System – without A/C

19260892

LC9 5.3L Accessory Drive System A/C Add-on Kit

Components needed to add A/C through your LC9-equipped vehicle.

- Kit includes mounting bracket, bolts, belt, A/C compressor and instruction sheet
- Intended to be used in conjunction with P/N 19369108 kit for non-A/C applications
- Not verified to work with any non-GM FEAD kit

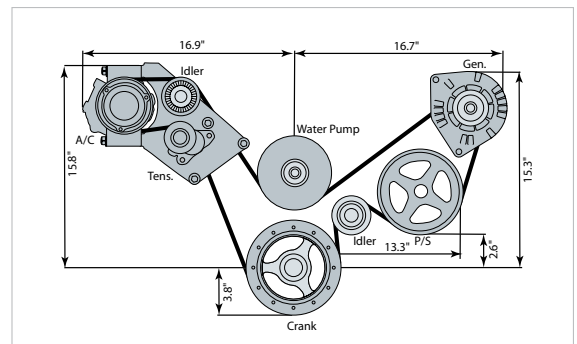
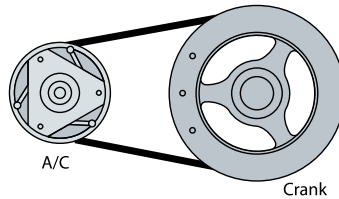

LS3 Accessory Drive System

19421448

LS3 Accessory Drive System

- High mount A/C provides clearance to frame
- Fits most non-LSA and non-LS9 SC engine

19329418

DR525 Accessory Drive System

- Fits all non-LSA and LS9 LS-type engines
- Most harmonic balancers do not line up correctly with the accessory drive system; damper P/N 12674582 is strongly recommended
- Direct bolt-on for LS3 & LS7 engines

NOTE: Use on LS327 iron block engine requires harmonic balancer P/N 12674582.

NOTE: Water pump P/N 12710208 NOT included with kit.

NOTE: Will not work with cam-phased engine.

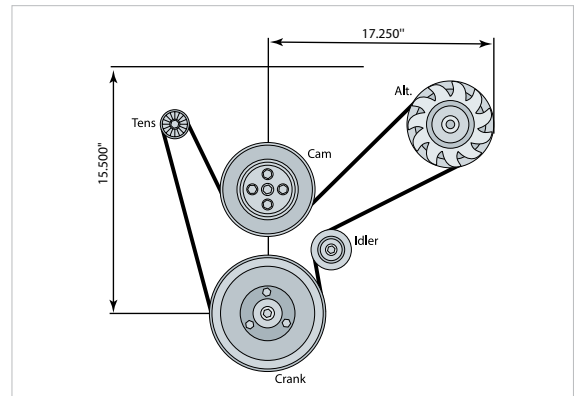

DR525 Accessory Drive System

LS/LT/LSX-SERIES COMPONENTS

Accessory Drive Systems continued

19421420

CTS-V Accessory Drive System – with A/C, Fixed Displacement Compressor

- Does not work on LS9 and LSA supercharged engines
- Most harmonic balancers do not line up correctly with the accessory drive system; damper P/N 12674582 is strongly recommended
- Air conditioning has separate belt; to delete air conditioning, do not install the belt, compressor or tensioner
- Fits all LS type engines, except production iron block applications
- Direct bolt-on for LS3 and LS7 engines

NOTE: Will not work with a cam-phased engine.

NOTE: Will not work on LS327 with cast-iron block.

NOTE: Water pump P/N 12710208 NOT included with kit.

NOTE: Includes fixed displacement compressor.

NOTE: Use P/N 19419286 for A/C add-on if Variable Displacement Compressor is needed.

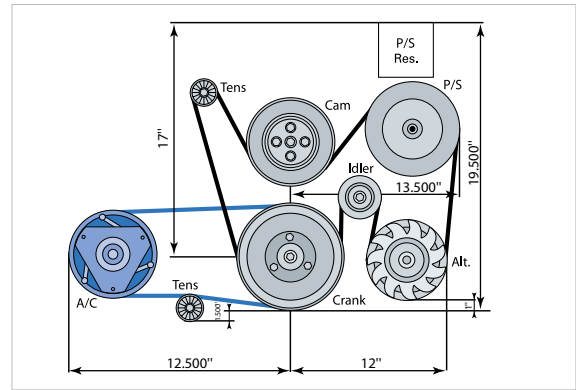

CTS-V Accessory Drive System – with A/C, Fixed Displacement Compressor

19421421

CTS-V Accessory Drive System – without A/C

- Does not work on LS9 and LSA supercharged engines
- Most harmonic balancers do not line up correctly with the accessory drive system; damper P/N 12674582 is strongly recommended
- Fits all LS type engines, except production iron block applications
- Direct bolt-on for LS3 and LS7 engines

NOTE: Will not work with a cam-phased engine.

NOTE: Will not work on LS327 with cast iron block.

NOTE: Water pump P/N 12710208 NOT Included with kit.

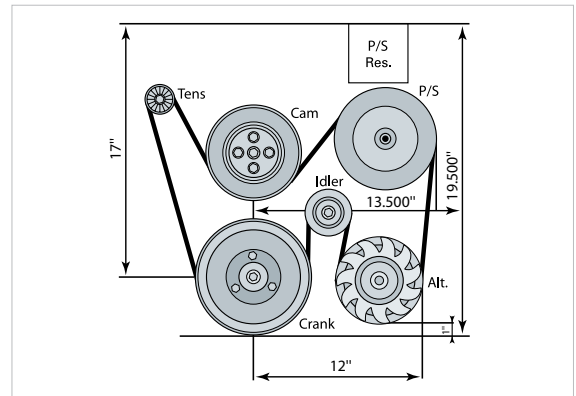

CTS-V Accessory Drive System – without A/C

19417547

LT1 Camaro Wet Sump Accessory Drive System – without A/C

- Includes alternator, brackets, tensioner and bolts
- Use A/C Add-on Kit P/N 19369182

19420208

LT1 Wet Sump Hydraulic Power Steering Add-on Kit

- Includes all parts to mount/add hydraulic power steering pump to LT1 wet sump engines only
- Mounts to LH side of engine
- Uses unique cast mounting bracket
- Uses modified production PS pump with 1500 psi relief valve setting
- Unique billet pulley
- LT4 production balancer and bolt included
- 7 rib "stretchy" belt drives PS pump on unique belt track

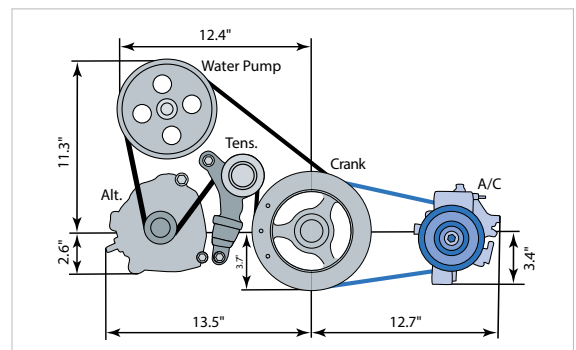

LT1 Camaro Wet Sump Accessory Drive System (19417547) with LT4 Wet Sump & LT1 Camaro A/C Add-on Kit (19369182)

19371521

LT4 Wet Sump Accessory Drive System – without A/C

- Fits Gen V LT4 wet sump engines
- Includes alternator, tensioners, brackets, belts, pulleys, bolts and instruction sheet
- Air conditioning has a separate belt—see kit P/N 19369182
- Production version of 2016 CTS-V and Camaro ZL1

19369182

LT4 Wet Sump & LT1 Camaro A/C Add-on Kit

- Kit includes mounting bracket, bolts, belt, compressor and instruction sheet
- Intended to be used in conjunction with P/N 19371521 or P/N 19417547 Chevy Performance kits
- Includes variable displacement compressor
- Production version of 2016 CTS-V

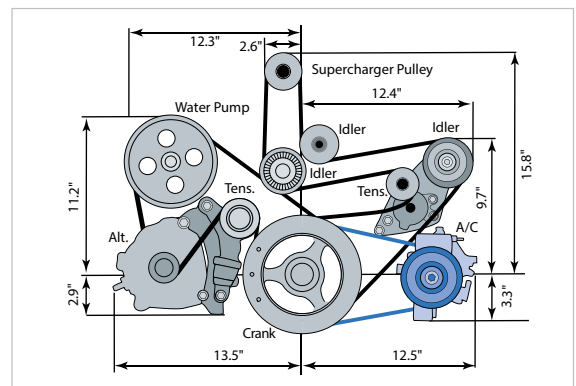

LT4 Wet Sump Accessory Drive System (19371521) with LT4 Wet Sump & LT1 Camaro A/C Add-on Kit (19369182)

19420210

LT4 Wet Sump Hydraulic Power Steering Add-on Kit

- Includes all parts to mount/add hydraulic power steering pump to LT4 wet sump engines only
- Mounts to LH side of engine
- Uses unique cast mounting bracket that replaces existing pulley/idler bracket
- Uses modified production PS pump with 1500 psi relief valve setting
- Unique billet pulley
- PS pump driven from 8 rib SC belt.02

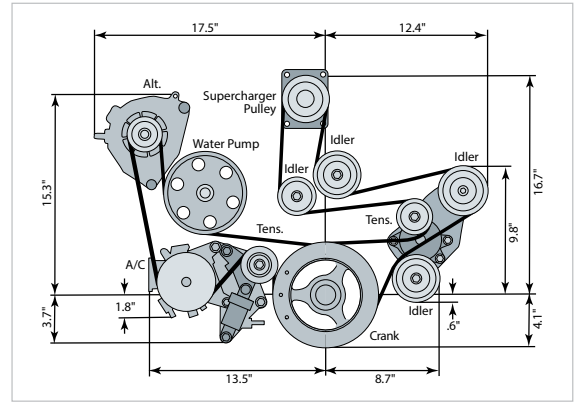

LT5 Accessory Drive System – with A/C

19417240

LT5 Accessory Drive System – with A/C

- Fits Gen V LT5 6.2L dry sump engine
- Includes alternator, tensioner, A/C compressor, S/C belt, pulleys, bolts and instruction sheet
- Production version of 2019 ZR1 Corvette Front End Accessory Drive

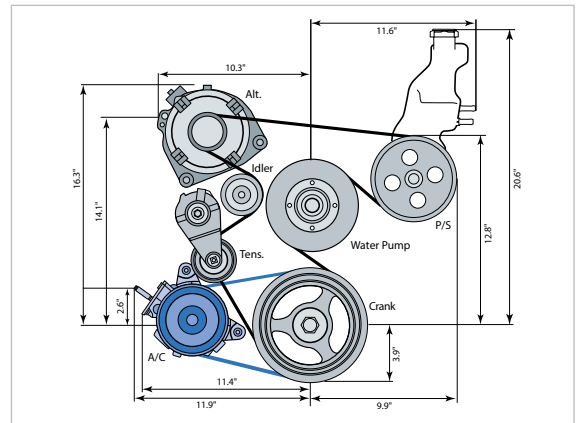

L8T/L8P 6.6L Accessory Drive System – with A/C

19433745

L8T/L8P 6.6L Truck Accessory Drive System – with A/C

- Use with L8T Crate Engine (P/N 19433748 pre 2024 or P/N 19435733 2024+), L8T Long Block Assembly (P/N 19433750) or L8P Crate Engine (P/N 19435523)
- Based on production accessory drive system used on Silverado HD models
- Includes variable-displacement air conditioning compressor, alternator, hydraulic power steering pump, brackets, pulleys, tensioners, belts and instruction sheet

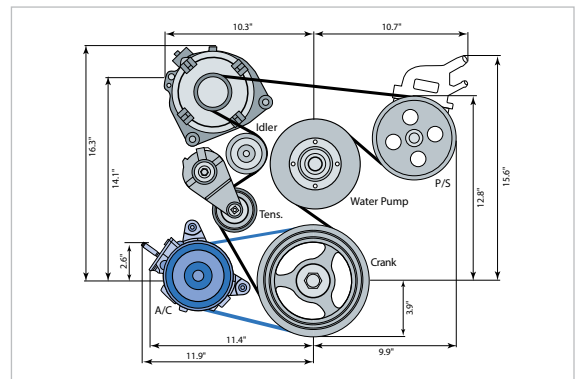

L8T/L8P 6.6L Passenger Car Drive System – with A/C

19433746

L8T/L8P 6.6L Truck Accessory Drive System – without A/C

- Use with L8T Crate Engine (P/N 19433748 pre 2024 or P/N 19435733 2024+), L8T Long Block Assembly (P/N 19433750) or L8P Crate Engine (P/N 19435523)
- Based on production accessory drive system used on Silverado HD models
- Includes alternator, hydraulic power steering pump, brackets, pulleys, tensioners, belts and instruction sheet

19540199

L8T/L8P 6.6L Passenger Car Drive System – with A/C

- Based on production accessory drive system used on GMT610 models
- Includes variable-displacement air conditioning compressor, alternator, hydraulic power steering pump, hose, remote reservoir, tensioners, belts and instruction sheet.

19540200

L8T/L8P 6.6L Passenger Car Drive System – without A/C (not shown)

Same as PN 19540199 but without air conditioning.

Rear FEAD Clearance Dimensions

FEAD Part Number (Original Equipment Application)	Belt Track (front of block to rear edge of main drive belt)	Belt Track (front of block to rear edge of supercharger belt)
19421444 (Corvette Non-Supercharged)	3"	6 Groove
19421445 (Corvette Non-Supercharged)	3"	6 Groove
19329418 (Corvette Non-Supercharged)	3"	6 Groove
19368946 (CTS-V LSA Supercharged) (discontinued)	3"	6 Groove 4.5" 8 Groove
19369108 (Truck)	4.5"	6 Groove
Gen 4 Camaro/Firebird (LS1) (production)	4"	6 Groove
Gen 5 Camaro (LS3/L99) (production)	4.75"	6 Groove

AC Compressor for FEADs

Part Number	Application	Style	Belt Track (front of block to rear edge of belt)
86811106	CTS-V	Fixed Disp	1.5" 4 Groove
19418175	Corvette	Variable Disp	1.5" 4 Groove
19418177	Corvette	Variable Disp	1.75" 6 Groove
37183465	Truck	Fixed Disp	3.5" 4 Groove

BALANCERS

A smooth-running engine depends on an effective balancer or torsional damper. Our dampers not only help LS engines run smoothly, they can extend engine life. Pick the right damper for your project from the list below.



Harmonic Balancer – LS1 and LS2



Harmonic Balancer – LS7

Part Number	Description	Technical Notes
19300488	Harmonic Balancer (not shown)	Originally used on L92 engines; For use in truck applications; WILL NOT work with our Serpentine Accessory Drive Systems
12553118	Harmonic Balancer	Originally used on LS1 and LS2 engines; For use in F-Car and GTO applications
12675716	Harmonic Balancer	Originally used on LS7 engines; For use in Corvette applications; Works with Chevrolet Performance Serpentine Accessory Drive System P/N 19421420 or P/N 19421444
12674582	Harmonic Balancer (not shown)	For LS3 engines; Works with Chevrolet Performance Serpentine Accessory Drive System P/N 19421420 or P/N 19421444

Balancer Bolts and Washers

Part Number	Description	Technical Notes
12557840	Balancer Bolt (not shown)	For LS1, LS2, LS3, LS6 and L92 engines
11570163	Balancer Bolt (not shown)	For LS7 engines
12674588	Friction Washer (not shown)	For LS2, LS3, L99, LS7 and L92 engines

WATER PUMPS AND COMPONENTS



Water Pump – LS2, LS3 and LS7 Engines



Water Pump – 2009 LSA, LS3/LS7, L76 SRX Engines

Part Number	Description	Technical Notes
19434033	Water Pump (not shown)	2007–2010 LS2 trucks, vans and SUVs
12710208	Water Pump	2005–2007 LS2; 2008 LS3; 2007–2008 LS7
12725009	Water Pump	2009–2010 LSA (CTS-V); 2009–2010 LS3 (Corvette) 2009 L76 SRX; 2009–2010 LS7 (Corvette)
12630223	Water Pump Gasket (not shown)	Requires 2 per engine; For LS1, LS2, LS3, LS6, LS7 and L92 engines
12551926	Water Pump Bolt (not shown)	Requires quantity of 6; For LS1, LS2, LS3, LS6, LS7 and L92

OIL PANS, OIL PUMPS, GASKETS AND COMPONENTS



Corvette Oil Pan – 2002–2004 LS6



F-Car Oil Pan



LS Circle Track Oil Pan



Muscle Car Oil Pan Kit

Part Number	Description	Technical Notes
12561828	Corvette Oil Pan – 2002–2004 LS6	Used on 2002–2004 Corvettes with LS6
12729417	F-Car Oil Pan	Used on 1998–2002 Camaro and Firebird LS1; Uses PF48 oil filter
19243065	LS Circle Track Oil Pan	Used on CT525 P/N 19434598; 6-quart capacity (8-quart with remote filter and adaptor); Requires remote oil filter and adaptor; Uses oil pan gasket P/N 12612350 (not included)
19212593	Muscle Car Oil Pan Kit	Fits virtually all 1955–1995 GM front engine, RWD, V-8 cars; 5-quart capacity; Includes oil pan, dipstick and tube, gaskets, pickup tube, windage tray and all mounting hardware; Wet sump design; Max stroke 3.620 w/windage tray
12612350	Oil Pan Gasket (not shown)	Requires 1 per engine; Fits all LS-Series engines except LS7 and LS9
12612351	Oil Pan Gasket (not shown)	Requires 1 per engine; For LS7 and LS9 engines
11515758	Oil Pan Bolt (not shown)	M8 x 30mm long; Requires 12 per engine (use 13 with LS7 and LS9 engines); For LS1, LS2, LS6, LS7 and L92 engines
12554990	Oil Pan Bolt (not shown)	M6 x 136mm long; Requires 2 per engine; For all LS-Series engines
12710304	Oil Pump (not shown)	For L92 engines
12623097	Oil Pump (not shown)	2-stage pump for LS7 engines; Will not work on standard LS crankshafts; Must use crank sprocket (P/N 12581278), timing damper (P/N 12581276), LS7 pickup tube (P/N 12580855), LS7 oil pan (P/N 12664619), and LS7 timing cover (P/N 12633907)
11519133	Oil Pump Bolt (not shown)	Requires 4 per engine; For all LS-Series engines

LS INTAKE MANIFOLDS

19540154

LS3 Intake Manifold Assembly

- Gen IV fuel-injection nylon manifold used on the 2009 Corvette LS3
- Fully assembled with injectors, fuel rail, 90mm ETC throttle body and gaskets
- For use with LS3/L92-style cylinder heads



19300534

ZL1 Supercharger

- Original equipment on LSA-powered 2012–2014 ZL1 Camaro
- Highly efficient Eaton Twin-Vortices, high-helix rotors
- 1.9L displacement
- Integrated air-to-liquid intercooler with front-facing lines
- Approximately 9 lbs psi boost on 6.2L engine



Assembly includes:

- Supercharger
- Intake system with injectors
- Ribbed cast cover and intercooler
- Front pulley
- Throttle body
- Gasket set

19301246

Air Inlet Kit for LS-Based Crate Engine Installation

- Designed for universal LS and LSX EFI crate engine installations
- Kit contains intake tubes with provisions for mass airflow meter and vacuum line, along with a reusable, high-performance air filter and mounting hardware
- Straight and elbow tubes provide the optimal distance between throttle opening and mass airflow meter, including the minimum length of straight tubing required for accurate mass airflow meter operation
- Includes polished intake tubes, couplers, worm-style clamps and a vacuum hose
- Mass airflow meter provision accepts all GM production meters (must be purchased separately)



13597903

LS9/LSA Intercooler Fluid Pump

- Includes pump assembly
- Additional hoses and clamps required to connect pump inline with coolant circuit



Parts intended for competition use only. See page 2 for details.



LS Intake Manifolds continued



88958675 ⚠️ ⚠️

LS2 4-bbl Intake Manifold

DISCONTINUED: Limited to stock on hand.

- Allows you to install a 4-bbl carburetor on an LS-Series engine with cathedral ports (LS1, LS2, LS6)
- Cast-aluminum open-plenum intake manifold accepts a 4150-style square-bore carburetor
- Bosses for EFI injectors for custom applications
- Bolts and instructions supplied

NOTE: LSX Ignition Controller P/N 19355418 is required for carbureted applications.



25534394 ⚠️ ⚠️

LS7 4-bbl Intake Manifold

DISCONTINUED: Limited to stock on hand.

- Lightweight GM racing design for use on LS7-style heads
- Reduced mass design, porting not recommended
- Includes mounting bolts and instructions
- Uses LS7 carb intake gasket set P/N 19172113
- Machined for 4150-style carburetors and has 3/8" NPT vacuum boss
- Also available with injector bosses, P/N 25534413

NOTE: LSX Ignition Controller P/N 19355418 is required for carbureted applications.

25534401 ⚠️ ⚠️

LS3/L92-Style 4-bbl Intake Manifold

- Lightweight GM racing design for use on LS3/L92-style cylinder heads
- Reduced mass design, porting not recommended
- Includes mounting bolts P/N 11609577 and instructions
- Uses L92 carb intake gasket set, P/N 19172114
- Machined for 4150-style carburetors and has 3/8" NPT vacuum boss
- Also available with injector bosses P/N 25534416

NOTE: LSX Ignition Controller P/N 19355418 is required for carbureted applications.



⚠️ Intake Manifolds: Additional Required Components

Part Number	Intake Gaskets	Bolts	Engine Application
25534394/25534413	19172113	Included with manifold	LS7 Carburetor Applications
25534401/25534416	19172114	Included with manifold	L76/L92 and LS3 Carburetor Applications
88958675	19156564	Included with manifold	LS2 Carburetor Applications

INTAKE MANIFOLD GASKETS AND COMPONENTS



LS Front Distributor Drive Cover

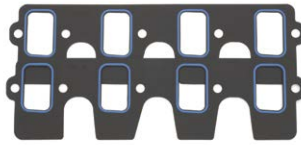

LS7 Carburetor Intake Gasket

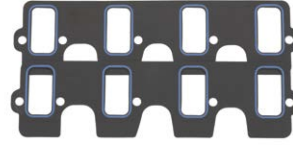

L92/LS3 Carburetor Intake Gasket



LS Header Flange

Part Number	Description	Technical Notes
88958679	LS Front Distributor Drive Cover	Assembly is manufactured for applications where a 4-bbl carburetor and distributor are required; Can be combined with GM's Bowtie valve covers P/N 25534398 and P/N 25534399 for a complete traditional-looking engine package; For all LS-Series engines except LS7, LSA and LS9 NOTE: Distributor and mechanical fuel pump not included. Uses Small-Block Ford-style distributor and mechanical fuel pump. Special water pump, accessory drive and damper required.
19172113	LS7 Carburetor Intake Gasket	For use with intake manifold P/N 25534394 or P/N 25534413; Includes 2 gaskets
19172114	L92/LS3 Carburetor Intake Gasket	For use with intake manifold P/N 25534401 or P/N 25534416; Includes 2 gaskets
19156564	LS2 Carburetor Intake Gasket (not shown)	For use with intake manifold P/N 88958675; Includes 2 gaskets
12480130	LS Header Flange	These 3/8" thick steel header flanges are a great way to start a fabricated set of LS-Series headers; For stock LS1, LS2, LS3, LS6, LS7 and L92 (may require clearancing) exhaust ports; Sold individually

DRY SUMP COMPONENTS

Dry Sump Oil Hose Adapters



Part Number	Description	Technical Notes
25534412	Dry Sump Oil Hose Adapters	Kit adapts the production LT1, LT4, LS7 and LS9 oil pan to aftermarket AN-style hoses for aftermarket dry sump oil tanks; Bolts directly to oil pan, and has AN male outlet for AN-12 fittings; Includes 1 adapter, 2 fittings, 2 bolts and 2 sealing gaskets
12603281	Oil Tank (not shown)	Fits 2006–2008 Z06 Corvette
15210122	Oil Inlet Hose (not shown)	Fits 2006–2013 Z06 Corvette
15210117	Oil Outlet Hose (not shown)	Fits 2006–2013 Z06 Corvette

STARTERS

LS-Series Starter

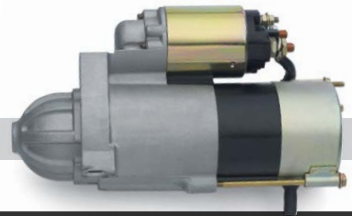

Part Number	Description	Technical Notes
10465385	LS-Series Starter	Works with all LS-Series and Gen IV V-8 engines, including the LS1, LS2, LS3, LS6, LQ9, LQ4 and LS7
12724248	LT4 Starter (not shown)	For 2015–2016 Z06 Corvette applications
89017844	Starter (reman, not shown)	Requires 1 per engine; For L92 engines
89017664	Starter (reman, not shown)	Requires 1 per engine; For 2005 Corvette applications; For LS2 engines
89017847	Starter (reman, not shown)	Requires 1 per engine; For 2006–2007 Corvette applications; For LS2, LS3 and LS7 engine

NOTE: All LS starters require one bolt P/N 11610633 and one bolt P/N 12561848.



Starters: Additional Required Components

Part Number	Bolts (Quantity)	Engine Application
10465385	11610633 (1), 12561848 (1)	LS-Series
12724248	11610633 (2)	LT4
89017844	12561387 (2)	L92
89017664	11610633 (2)	LS2
89017847	11610633 (2)	LS2, LS3 and LS7



Parts intended for competition use only. See page 2 for details.



Additional components required for installation. See chart above.



CARBURETORS



Carburetor – Holley 670-cfm



Carburetor – Holley 850-cfm



Carburetor – Holley 870-cfm

Part Number	Description	Technical Notes
19420450	Carburetor – Holley 670-cfm	Holley 4150-style 670-cfm 4-bbl carburetor; Features show-car-quality polished finish; Dual-feed center-hung fuel bowls; Vacuum secondaries; Electric choke; Power valve blowout protection; Quick-change adjustable vacuum secondary; Bolts and gaskets included
19420445	Carburetor – Holley 770-cfm (not shown)	Holley 4150-style 770-cfm 4-bbl carburetor; Features show-car-quality polished finish; Dual-feed center-hung float bowls; Vacuum secondaries; Automatic electric choke; Quick-change adjustable vacuum secondary; Recommended for Small-Block and Big-Block engines; Bolts and gaskets included
19420446	Carburetor – Holley 850-cfm	Holley 4150-style 850-cfm 4-bbl carburetor; Features show-car-quality polished finish; Mechanical secondaries; Electric choke; Four-corner idle adjustment; Power valve blowout protection; Custom-calibrated for the ZZ572/620 crate engine; Recommended for 502 crate engines and suitable for Big-Block engines; Bolts and gaskets included; NOTE: Carburetor can only be recalibrated for use with other large-displacement engines
19420447	Carburetor – Holley 870-cfm	Holley 4150-style 870-cfm 4-bbl carburetor; Features show-car-quality polished finish; Dual-feed center-hung float bowls; Vacuum secondaries; Automatic electric choke; Quick-change adjustable vacuum secondary; Recommended for 502 crate engines, suitable for Big-Block engines; Bolts and gaskets included; Replaces 4150-style 850-cfm carburetor P/N 19170094

AIR CLEANERS

Air Cleaner – Chevrolet-Logo High-Performance Design



Air Cleaner – Chevrolet-Logo Classic Design



Part Number	Description	Technical Notes
12342080	Air Cleaner – Chevrolet-Logo High-Performance Design	14" round high-performance-style air cleaner; Chrome lid with embossed Chevrolet name; Fits most 4-bbl and 2-bbl carburetors; NOTE: Check clearance between hood and top of air cleaner. Minimum clearance is 3.75" from top of carburetor gasket area to underside of hood.
12342071	Air Cleaner – Chevrolet-Logo Classic Design	14" round classic-style air cleaner; Chrome lid with embossed Chevrolet name and Bowtie attaching nut; Fits most 4-bbl and 2-bbl carburetors

FUEL INJECTORS



19420801
LT4 Injector Kit

- Production direct-injection fuel injectors for the supercharged LT4 engine
- Flow rate of approximately 140 lbs./hr. at max pressure of 2,950 psi
- Higher flow rate than LT1 injectors
- Eight injectors per kit. Order one kit per engine
- Tuning required for non-LT4 applications



ELECTRICAL AND FUEL COMPONENTS

Ignition Controllers

Part Number	Description	Technical Notes
19355418 	LS/LSX Ignition Controller	Distributorless plug-in ignition system for carbureted LS engines with 58x & 24x reluctor wheel; Several pre-programmed timing curves provided; Supplied software allows you to create custom vacuum advance curves, timing curves, program low and high rpm rev limiter and step retard; Plugs into stock sensors (not provided); MAP sensor provided; Compatible with all LS-Series ignition coils
19355863 	LS CT525 Circle Track Ignition Controller	Required to operate CT525 Circle Track crate engine; Preset timing curve and rev limiter; Direct plug-in to factory LS sensors and coils; Includes complete ignition wiring harness

Spark Plugs





Part Number	Description	Technical Notes
12571165	Spark Plug (not shown)	Requires 8 per engine; AC 41-101; For LS7, LSA and LS9 engines
12680072	Spark Plug (not shown)	Requires 8 per engine; AC 41-985; For LS1, LS2, LS3, LS6 and L92 engines

Spark Plug Wires

Chevrolet Performance spark plug wire kits are designed to fit your GM engine, eliminating the guesswork in selecting the correct length.

Part Number	Description	Technical Notes
19433387	Spark Plug Wire Set – LS-Series V-8	Direct-fit wire set with factory-style boots and terminals; Designed for over-valve-cover installation
19329681	Spark Plug Wire Shield (not shown)	Requires 8 per engine; For all LS-Series engines

Fuel Pumps and Components

Part Number	Description	Technical Notes
6472657 	Electric Fuel Pump	For use on all carbureted engines; Flows 30–40 gph at 6–9 psi
19303293 	Camaro ZL1 Fuel Pump Module	Production fuel pump module for the 2012 Camaro ZL1 with supercharged LSA engine; Supports approximately 600 horsepower; Direct replacement for 2010+ Camaro SS fuel pump modules; 250 liters per hour capacity at 65 psi; Pulse-width modulated, eliminates need for conventional pressure regulator; Kit includes fuel pump module/sender assembly tank seal and instruction sheet
25115899 	Electric Fuel Pump – High-Output	Heavy-duty 12-volt electric rotary pump; Flows 72 gph at 6–8 psi
854619 	Fuel Filter (not shown)	High-capacity in-line filter; Suitable for all high-performance carbureted applications; 5/8" inlet and outlet
19239926 	LS Fuel Filter (not shown)	1999–2003 Corvette stock fuel filter; Built-in fuel pressure regulator; Mounts to frame; Supplies constant 55–61 psi of fuel to engine and returns excess to fuel tank



LS/LSX Ignition Controller



LS CT525 Circle Track Ignition Controller



Spark Plug Wire Set – LS-Series V-8



Electric Fuel Pump



Camaro ZL1 Fuel Pump Module



Electric Fuel Pump – High-Output



Engine Control Modules and Harnesses



The engine control module is the brain of your Gen IV LS- or Gen V LT-powered project vehicle. Chevrolet Performance is your source for controllers designed for easy "plug-and-play" installation. In most applications, there is no need for third-party tuning adjustments.

Unlike controllers from regular-production vehicles, which may or may not come with a used engine, Chevrolet Performance controllers are uniquely calibrated for installation in older vehicles. That means many features required for late-model production vehicles are "turned off," because they're not required in older cars and trucks. That prevents the unnecessary triggering of diagnostic trouble codes that could possibly affect performance or require additional calibration adjustments.

Our inclusive kits deliver all the components required to plug into the engine and get it running—from the controller itself and the accompanying wire harness to the mass airflow sensor, oxygen sensors and even a throttle pedal assembly for engines equipped with an electronic throttle body. The kits also include detailed instructions to help you do it right the first time, even if you have no experience.

Most kits include:

- Two oxygen sensors
- Two oxygen sensor mounting bosses (for installation in the exhaust system)
- A mass airflow meter
- A mass airflow meter mounting boss (for installation in the air intake system)
- A throttle pedal assembly (for use with the electronically operated throttle)
- A specific oil pressure sensor that is compatible with the harness (when needed)
- A complete wiring harness with fuse-box and necessary cam sensor and MAP sensor jumpers
- Fuel pump power module for direct-injected engines
- Fuel pressure sensor for direct-injected engines
- The programmed controller
- An instruction sheet

Each Chevrolet Performance controller kit is a true stand-alone system. All that's needed to get a vehicle running with it are power and ground sources, a high-pressure fuel pump and an electric cooling fan.

QUICK INSTALLATION TIPS

INSTALLING THE ECM – The ECM is weather-resistant and can be mounted under the hood, but it should be placed to avoid extreme heat and away from potential splash. Chevrolet Performance does not recommend mounting it directly to the engine.

ACCELERATOR PEDAL – Chevrolet Performance's controller kits are designed for use with factory-type electronic throttles (no conventional throttle cable) that require a matched accelerator pedal. The pedal contains an electronic sensor that conveys to the controller when and how much to open the throttle. The pedal should be mounted at least 2.5 inches to the right of the brake pedal and 2 inches below it. There should be at least .75-inch clearance between the pedal and the transmission tunnel/center console. The pedal has a wire harness that connects to the controller, requiring it to be fed through the firewall—possibly requiring a new hole. Use a grommet on the hole to prevent chafing of the harness.

MAF – The mass airflow meter that comes with some controller kits must be mounted in a 4-inch-diameter tube that has at least a 6-inch-long straight section. The kit includes the bracket and mounting bosses onto which the meter is secured on the tube—the tube must be cut to allow the meter to hang inside of it. The meter sensor must be mounted at the center of the straight section, making sure that is at least 10 inches from the throttle body. Orienting the MAF is essential for proper operation. The meter's sensor should be mounted with the connector end pointed between horizontal and fully upright. Chevrolet Performance's universal air induction kit—P/N 19301246—works for most applications.

OXYGEN SENSORS – The oxygen sensors (one for each side of the exhaust) must be inserted in the exhaust stream ahead of the catalytic converters (if used). Holes are simply drilled into the exhaust tubing and the mounting bosses welded to them. After that, the oxygen sensors simply screw onto the mounting bosses and are connected to the wire harness.

ENGINE CONTROLLER KITS AND COMPONENTS 

Part Number	Description	Technical Notes
19369180	LC9 5.3L Engine Controller Kit	Specially programmed for retrofit applications, for quicker and easier adaptation of GM's popular 5.3L V-8; Works with 2007–2009 5.3L engines with the following engine codes: LC9 (2007–2009), LH8 (2008–2009), LY5 (2007–2009), LMF (2008–2009) and LMG (2007–2009)—non-cam-phased engines; Does not engage cylinder-deactivating Active Fuel Management and other features not required for retrofit installations; For individual engine controller, use P/N 19354325 (included in kit)
19369208	LC9 5.3L Engine Controller Kit	Specially programmed for late model 5.3L LC9 cam-phased engines (2010 and newer); Does not engage cylinder-deactivating Active Fuel Management and other features not required for retrofit installations; For individual engine controller, use P/N 19354327 (included in kit); This is the optimum off-road kit for the LC9 5.3L engine P/N 19259918
19418490	L96 6.0L Engine Controller Kit	Includes all components needed to run L96 6.0L crate engine P/N 19416591 (discontinued)
19354328	LS2/LS3 Engine Controller Kit	Includes all the components required to run the LS3 crate engine; Max rpm 6,600; For individual engine controller, use P/N 19354329 (included in kit)
19354330	LS376/480 Engine Controller Kit	Includes all the components required to run your LS376/480 crate engine P/N 19540156; Max rpm 6,600 For individual engine controller, use P/N 19354331 (included in kit)
19354332	LS376/525 Engine Controller Kit	Includes all the components required to run LS376/525 crate engine P/N 19540157; Max rpm 6,600; For individual engine controller, use P/N 19354333 (included in kit)
19354334	LS7 Engine Controller Kit	Includes all the components required to run your 2006–2013 LS7 crate engine; For individual engine controller, use P/N 19354335 (included in kit); Will run all M/Y LS7s with MAP sensor 12644569; Max rpm 7,100
19420000	LS427/570 Engine Controller Kit	Includes all the components required to run your LS427/570 crate engine P/N 19421004; Includes specific calibration for LS427/570 camshaft
19369381	LSA Engine Controller Kit	Includes all the components required to run LSA crate engine P/N 19370850; Max rpm 6,200; For individual engine controller, use P/N 19354337 (included in kit)
19369382	LS9 Engine Controller Kit	Includes all components required to run LS9 crate engine P/N 19260165; Max rpm 6,600; For individual engine controller, use P/N 19354339 (included in kit)
19418585	LT1 Wet & Dry Sump with 4–Pin Sensor & 4L/6–speed manual	Includes all components needed to run LT1 Wet Sump crate engine with a 4-pin fuel pressure sensor, with a 4-speed automatic or T56 Super Magnum manual transmission; Also includes an E-92 controller and fuel pump power module
19433246* 2022+	LT1 Wet & Dry Sump with 3–Pin Sensor & 4L/6–speed manual transmission	Includes all components needed to run LT1 crate engine P/N 19431953, with 3-pin fuel pressure sensor with a 4-speed automatic or 6-speed manual transmission; Also includes an E-92 controller and fuel pump power module
19418587* Pre 2022		
19433601* 2022+	LT1 Wet & Dry Sump with 3–Pin Sensor & 6L80	Includes all the components to run MY 2022 or newer LT1 with 6L80 Supermatic automatic transmission.
19433247* 2022+	LT1 Wet & Dry Sump with 3–Pin Sensor & 8L/10L transmission	Includes all components needed to run LT1 crate engine with 3-pin fuel sensor P/N 19431953 with an 8-speed SuperMatic transmission; Includes E-92 controller, fuel pump power module and fuel pressure sensor for direct injection
19418589* Pre 2022		
19418591	LT376-535 with 3–Pin Sensor & 4L/6–speed manual transmission	Includes all components needed to run LT376/535 crate engine P/N 19355378; Includes E-92 controller, fuel pump power module and fuel pressure sensor for direct injection (4L/6-speed manual only)
19418595	LT4 Wet & Dry Sump with 4–Pin Sensor & 4L/6–speed manual	Includes all components needed to run LT4 Wet Sump crate engine, P/N 19431955, with 4-pin fuel pressure sensor with a 4-speed automatic or 6-speed Super Magnum manual transmission; Also includes E-92 controller and fuel pump power module
19433248* 2022+	LT4 Wet Sump Engine Controller Kit (Camaro ZL-1) with 4L/6–speed manual transmission	Includes all components needed to run LT4 Wet Sump crate engine P/N 19431955 for the Camaro ZL-1 with 3-pin fuel pressure sensors with a 4-speed automatic, 6-speed automatic or 6-speed manual transmission; Also includes an E-92 controller and fuel pump power module
19419241* Pre 2022		
19433632* 2022+	LT4 Wet Sump with 3–Pin Sensor & 6L80 transmission	Includes all the components to run MY 2022 or newer LT4 with 6L80 Supermatic automatic transmission.
19433249* 2022+	LT4 Wet & Dry Sump with 3–Pin Sensor & 8L/10L	Includes all components needed to run LT4 Wet Sump crate engine P/N 19431955 for the Camaro ZL-1 with 3-pin fuel pressure sensors with an 8-speed or 10-speed SuperMatic transmission; Also includes an E-92 controller and fuel pump power module
19419242* Pre 2022		
19418270	LT5 Engine Controller Kit for Manual Transmission	Includes all components needed to run LT5 Dry Sump crate engine P/N 19417105 (discontinued) for the 2019 ZR1 Corvette. NOTE: Calibration only supports a manual transmission—requires top-of-clutch input signal; 40X vehicle speed signal must be supplied to ECM through VSS connector (included with harness); Use P/N 19329912 Transmission Installation Kit.
19418244	LT5 Engine Controller Kit for 8-Speed Transmission	Includes all components needed to run LT5 Dry Sump crate engine P/N 19417105 (discontinued) with SuperMatic™ 8L90-E automatic transmission P/N 19419800; Use with transmission installation kit P/N 19417103 (slip yoke).
19435726 2024+	L8T Engine Controller Kit for 6L80 Transmission	Includes all components needed to run the L8T crate engine, P/N 19435733 (2024+), with a 6L80 automatic transmission only. Includes E-93 controller, Fuel Pump Power Module, High Pressure Fuel Sensor and all other components needed for proper operation.
19435606	L8T Engine Controller Kit for 10L90 Transmission	Includes all components needed to run the L8T crate engine, P/N 19435733 with a 10L90 automatic transmission only. Includes E-93 controller, Fuel Pump Power Module, High Pressure Fuel Sensor and all other components needed for proper operation.
19435524	L8P Controller Kit	Includes all components needed to run the L8P crate engine, PN 19435523 with a 6L80 automatic transmission only. Includes E-93 controller, Fuel Pump Power Module, High Pressure Fuel Sensor and all other components needed for proper operation.
19354340	DR525 Engine Controller Kit	Engine controller and harness kit for operating DR525 racing engines P/N 19434599 and 19434600; Includes throttle pedal for electronic throttle body communication. NOTE: The engine controller in this kit is a "factory-sealed unit, incorporating a tamper-proof design" to comply with rules mandated by the NMCA.
19432870	DR525 Engine Controller Kit	Engine controller and harness kit for operating DR525 racing engines P/N 19434599 and 19434600; Includes updated calibration with 7K RPM limit, C10 fuel and reduced knock retard calibration. NOTE: The engine controller in this kit is a "factory-sealed unit, incorporating a tamper-proof design" to comply with rules mandated by the NMCA.
19369179	LSX454 Engine Controller Kit for Manual Transmission	Includes all the components required to run LSX454 crate engine P/N 19417357 with a Manual transmission; Max rpm 7000; For individual engine controller, use P/N 19354345 (included in kit)
19354342	LSX454 Engine Controller Kit for Automatic Transmission	Includes all the components required to run LSX454 crate engine P/N 19417357 with an automatic transmission; Max rpm 7000; For individual engine controller, use P/N 19354343.

***IMPORTANT NOTE:** Do not use pre-2022 LT1 and LT4 Engine Controllers with 2022 LT1 and LT4 crate engines. Correct applications are listed above.



Parts intended for competition use only.
See page 2 for details.



Performance

115

Small-Block Crate Engines

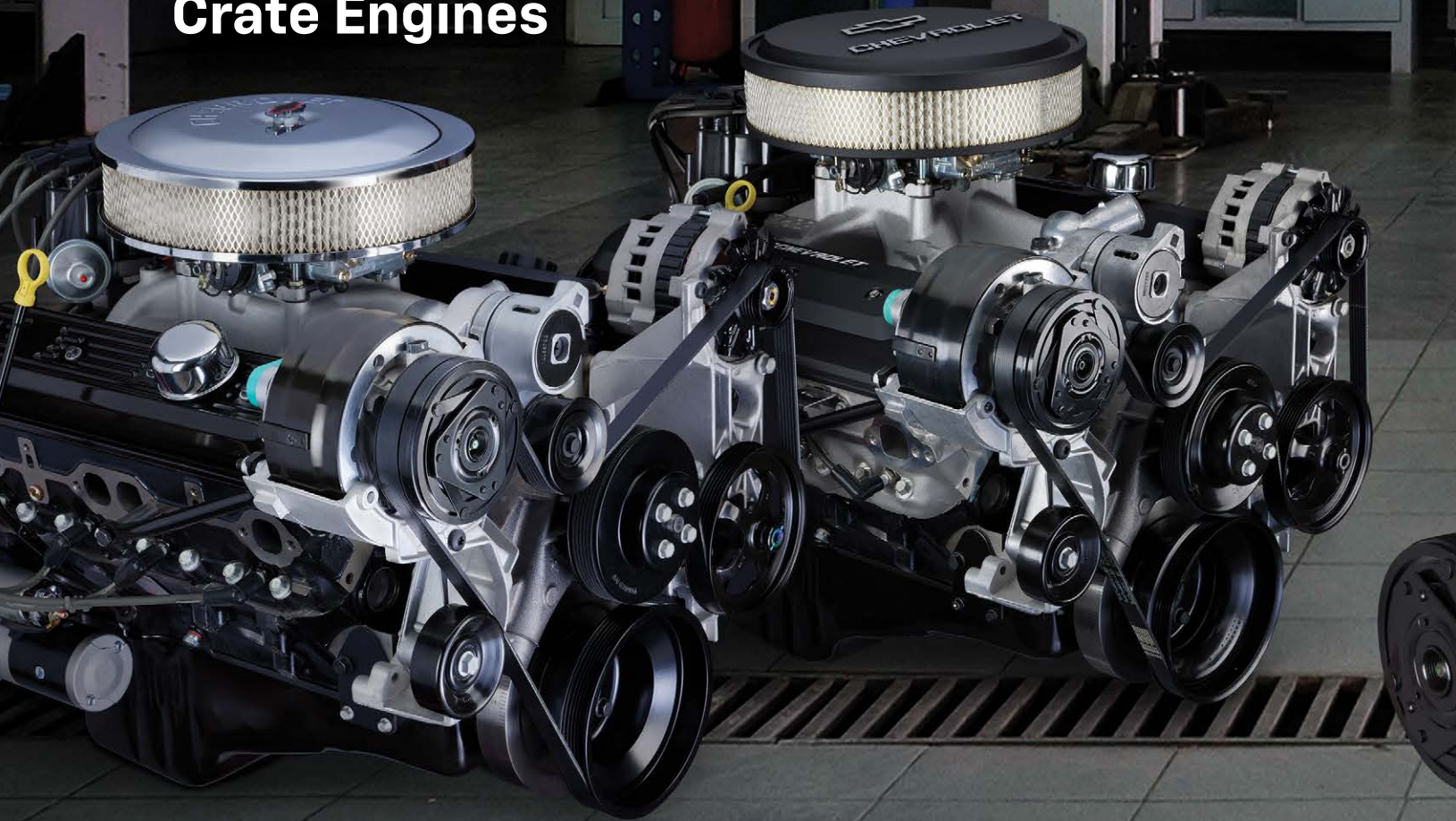

A legacy of high performance

The Chevy Small-Block is the V-8 engine that America grew up with. It continues to offer builders great power, application flexibility and value. Our range of Small-Block crate engines has something for everyone and almost every budget, including the SP383 EFI, which blends stroker torque, modern valvetrain technology and EFI drivability. With a Chevrolet Performance crate engine, you're not just installing an engine. You're building history!

Check out the following pages to find the Chevrolet Performance Small-Block Engine that's right for you!

350 HO TURN-KEY	118	ZZ6 EFI TURN-KEY	126
350 HO DELUXE	119	ZZ6 EFI DELUXE	127
350 HO BASE	119	HT383	128
SP350/357 TURN-KEY	120	HT383E	130
SP350/357 DELUXE	121	SP383 TURN-KEY	132
SP350/357 BASE	121	SP383 DELUXE	133
SP350/385 TURN-KEY	122	SP383 BASE	133
SP350/385 BASE	123	SP383 EFI TURN-KEY	134
ZZ6 TURN-KEY	124	SP383 EFI DELUXE	135
ZZ6 BASE	125		

NOTE: Engines may not come with all the parts shown in photo. See your dealer for more details.



Engines shown from left:
SP350/357 Turn-Key, ZZ6 Turn-Key,
SP383 EFI Turn-Key

350 HO Turn-Key

19433031 

333 hp

@ 5,100 rpm

381 lb.-ft.

@ 3,700 rpm

DYNO CHART

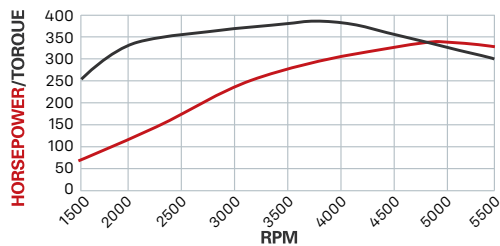

NOTE: Refer to page 6 for the complete horsepower and torque testing procedures.



The classic 350 to drive your project!

Chevrolet Performance's 350 HO crate engine is a smart and powerful alternative to rebuilding. In fact, with its high-flow cylinder heads, a strong hydraulic camshaft and a four-barrel carburetor, it's rated at 333 horsepower and 381 lb.-ft. of torque. That's more power than almost every 350 engine ever offered in a production vehicle.

The 350 HO is built on a sturdy, all-new block with four-bolt mains. It's topped with a set of Vortec cylinder heads, and the contemporary hydraulic flat-tappet camshaft supports a broad power band, while requiring no periodic lash adjustments.

As one of our Turn-Key crate engines, the 350 HO Turn-Key comes with the intake manifold and distributor installed. It also includes the carburetor, front-end accessory kit, chrome air cleaner, starter, and spark plug wires (some installation required).

INSTALLATION NOTES

- Comes with 12.750" externally balanced 153-tooth automatic transmission flexplate. Requires externally balanced flywheel for manual transmission. See chart on page 157
- Has right-side oil dipstick
- Requires fuel line from fuel pump to carburetor
- Some assembly and minor engine tuning required
- Not intended for marine applications
- Chevrolet Performance Front Accessory Drive Kits include a reverse rotation water pump

Mobil 1 is the recommended engine oil for all Chevrolet Performance Engines

TECH SPECS

Part Number:	19433031
Engine Type:	Chevy Small-Block V-8
Displacement (cu in):	350
Bore x Stroke (in):	4.000 x 3.480
Block (P/N 19431835):	Cast iron with 4-bolt main caps
Crankshaft (P/N 12691722):	Forged Steel
Connecting Rods (P/N 10108688):	Forged powder metal, shot peened
Pistons (P/N 88954280):	Cast aluminum
Intake Manifold (P/N 12496820):	Dual-plane aluminum
Camshaft Type (P/N 24502476):	Hydraulic flat tappet
Valve Lift (in):	.435 intake / .460 exhaust
Cylinder Heads (P/N 12691728):	Vortec iron; 62cc chambers
Valve Size (in):	1.940 intake / 1.500 exhaust
Compression Ratio:	9.6:1
Rocker Arms (P/N 10089648):	Stamped steel
Rocker Arm Ratio:	1.5:1
Water Pump (P/N 19417097):	Cast iron, long-style
Recommended Fuel:	Premium pump
Ignition Timing:	32° Total @ 4,000 rpm
Maximum Recommended rpm:	5,100
Balanced:	External
Flexplate (P/N 14088765):	12.750"

NOTE: Distributor with melonized steel gear **MUST** be used with long-blocks and partial engines with steel camshafts, or engine damage will occur.



Chevrolet Performance Crate Engines include a 24-month or 50,000-mile/80,000-kilometer limited warranty, whichever comes first. See your GM dealer for details.



Chevrolet Performance **does not** utilize any used or remanufactured parts in this crate engine, except for the starter, alternator and power steering pump.



This part is intended for competition use only. See page 2 for complete details.

ADDITIONAL BUILD OPTIONS

19433038 
350 HO Deluxe

Like the 350 HO Turn-Key crate engine, the 350 HO Deluxe is rated at 333 horsepower and 381 lb.-ft. of torque. It comes with the intake manifold, carburetor and distributor installed.



19433030 
350 HO Base

All the same important, power-building elements as the Turn-Key and Deluxe versions, but it comes without an intake manifold, carburetor, water pump or distributor.



CONNECT & CRUISE CONFIGURATIONS

Chevrolet Performance's Connect & Cruise systems match our crate engines with transmissions for factory-tailored performance combinations—including supporting controllers and installation kit recommendations—that take the guesswork out of your project. See page 32 for more details.

350 HO Turn-Key with 4L65-E Automatic 

Engine:	19433031	Torque Converter:	19299800
Transmission:	19368611	Controller:	19332775
Install Kit:	19420473		



TRANSMISSION OPTIONS

See pages 20–31 for additional options.

19368611
SuperMatic™ 4L65-E Four-Speed Automatic (remanufactured)

Based on the 4L60-E, the 4L65-E electronically controlled four-speed automatic is rated for up to 430 lb.-ft. of torque. For strength, it features five-pinion gearsets, heat-treated stator shaft splines, an induction-hardened turbine shaft and more. See page 24 for more details.



19352208
Super Magnum Six-Speed Manual

This high-torque capacity TREMEC six-speed manual is designed for custom, retro-fit installations with Chevrolet Performance crate engines. It has a 700-lb.-ft. torque capacity and features a 40-tooth reluctor ring. See page 29 for more details.



ENGINE-RELATED PARTS & ACCESSORIES



19433118
Transmission Installation Kit
page 25



19329025
Bell Housing Kit
page 29



19299800
Torque Converter
page 22



19332775
Transmission Controller
page 28



19433448 
High-Torque Mini Starter
page 164

SP350/357 Turn-Key

19433034 

357 hp

@ 5,500 rpm

407 lb.-ft.

@ 4,000 rpm

DYNO CHART

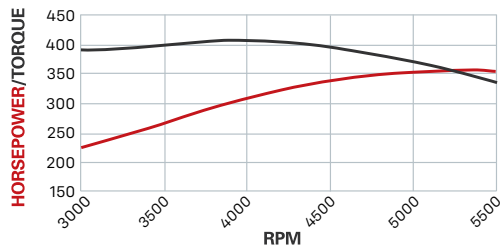

NOTE: Refer to page 6 for the complete horsepower and torque testing procedures.



An affordable small-block performer!

With 357 horsepower and more than 400 lb.-ft. of torque, the Chevrolet Performance 350/357 Turn-Key offers a great combination of performance and value.

Modern valvetrain technology is the key to its high-revving capability, pushing power to 5,500 rpm, while economical iron cylinder heads deliver excellent airflow and help make this potent crate engine more affordable. They're matched with a friction-reducing roller camshaft that helps optimize performance across the rpm band.

The rest of 350/357 Turn-Key is built with strong, all-new components, including a brand-new four-bolt block, a durable nodular iron crankshaft and more. The Turn-Key Engine comes with the intake manifold and distributor installed. It also includes the carburetor, front-end accessory kit, chrome air cleaner, starter, and spark plug wires (some installation required).

INSTALLATION NOTES

- Front-end accessory drive included but not installed for shipment
- Comes with 12.750" externally balanced 153-tooth automatic transmission flexplate. Requires externally balanced flywheel for manual transmission. See chart on page 157
- Requires fuel supply line to carburetor
- Not intended for marine applications

Mobil 1 is the recommended engine oil for all Chevrolet Performance Engines

TECH SPECS

Part Number:	19433034
Engine Type:	Chevy Small-Block V-8
Displacement (cu in):	350
Bore x Stroke (in):	4.000 x 3.480
Block (P/N 19431835):	Cast iron with 4-bolt main caps
Crankshaft (P/N 12691722):	Forged Steel
Connecting Rods (P/N 10108688):	Forged powder metal, shot peened
Pistons (P/N 88894280):	Cast aluminum
Intake Manifold (P/N 12676887):	Dual-plane aluminum
Camshaft Type (P/N 12677151):	Hydraulic roller
Valve Lift (in):	0.473 intake / 0.473 exhaust
Camshaft Duration (@.050 in):	215° intake / 223° exhaust
Cylinder Heads:	Cast iron; as cast with 62cc chambers
Valve Size (in):	1.940 intake / 1.500 exhaust
Compression Ratio:	9.0:1
Rocker Arms (P/N 19210725):	Stamped steel
Rocker Arm Ratio:	1.5:1
Recommended Fuel:	Premium pump
Ignition Timing:	32° Total @ 4,000 rpm
Maximum Recommended rpm:	5,600
Balanced:	External
Flexplate (P/N 14088765):	12.750"

NOTE: Distributor with melonized steel gear **MUST** be used with long-blocks and partial engines with steel camshafts, or engine damage will occur.



Chevrolet Performance Crate Engines include a 24-month or 50,000-mile/80,000-kilometer limited warranty, whichever comes first. See your GM dealer for details.



Chevrolet Performance **does not** utilize any used or remanufactured parts in this crate engine, except for the starter, alternator and power steering pump.



This part is intended for competition use only. See page 2 for complete details.

ADDITIONAL BUILD OPTIONS



19433033

SP350/357 Deluxe

Positioned between the SP350/357 Turn-Key and Base engine kits, this Deluxe version includes the intake manifold, distributor and flexplate installed. A Holley four-barrel carburetor is also included, but not installed.



19433032

SP350/357 Base

This assembled long block includes the signature roller camshaft, cylinder heads and contemporary valvetrain components of the Turn-Key crate engine, as well as the oil pan and front cover installed, but requires additional components to complete.



19435619

SP350/ZZ6 Partial Engine

The SP350 Partial is based on the popular ZZ6 engine assembly and includes a forged steel crankshaft, high-silicon pistons and durable connecting rods.

CONNECT & CRUISE CONFIGURATIONS

Chevrolet Performance's Connect & Cruise systems match our crate engines with transmissions for factory-tailored performance combinations—including supporting controllers and installation kit recommendations—that take the guesswork out of your project. See page 32 for more details.

SP350/357 Turn-Key with 4L65-E Automatic

Engine:	19433034	Torque Converter:	19299801
Transmission:	19368611	Controller:	19332775
Install Kit:	19420473		

SP350/357 Turn-Key with Super Magnum Six-Speed Manual

Engine:	19433034	Install Kit:	19329900
Transmission:	19352208		



TRANSMISSION OPTIONS

See pages 20–31 for additional options.

19368611

SuperMatic™ 4L65-E Four-Speed Automatic (remanufactured)

Based on the 4L60-E, the 4L65-E electronically controlled four-speed automatic is rated for up to 430 lb.-ft. of torque. For strength, it features five-pinion gearsets, heat-treated stator shaft splines, an induction-hardened turbine shaft and more. See page 24 for more details.



19352208

Super Magnum Six-Speed Manual

This high-torque capacity TREMEC six-speed manual is designed for custom, retro-fit installations with Chevrolet Performance crate engines. It has a 700-lb.-ft. torque capacity and features a 40-tooth reluctor ring. See page 29 for more details.



ENGINE-RELATED PARTS & ACCESSORIES



19433118
Transmission Installation Kit

page 25



19332775
Transmission Controller

page 28



19299800
Torque Converter

page 22



Parts intended for competition use only.
See page 2 for details.



Performance

121

SP350/385 Turn-Key

19433040 

385 hp

@ 5,600 rpm

405 lb.-ft.

@ 3,600 rpm

DYNO CHART

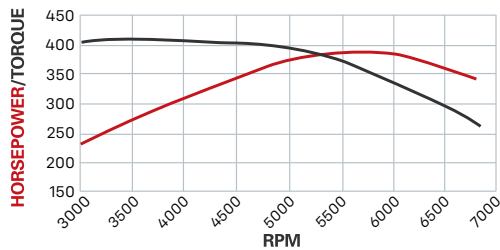

NOTE: Refer to page 6 for the complete horsepower and torque testing procedures.



Modern valvetrain technology helps this 350 rev!

Chevrolet Performance's SP350/385 Turn-Key uses aluminum Fast Burn cylinder heads equipped with LS-style beehive valve springs for greater high-rpm performance that helps this power-dense engine offer 385 horsepower and 405 lb.-ft. of torque.

The lightweight cylinder head casting features large, 210cc intake runners, with the beehive valve springs matched with steel retainers, machined steel spring seats and split key locks. The beehive-style valve springs allow the SP350/385 to rev higher to make the most of every cubic inch of air drawn through it.

Like all of our Small-Block crate engines, this one is built with a brand-new block with four-bolt mains and it features a hydraulic roller camshaft. The turn-key engine package includes the distributor, carburetor, and balancer installed. The front-end accessory kit, chrome air cleaner, starter, and spark plug wires are also included (some installation required).

INSTALLATION NOTES

- SP350/385 Base Engine (P/N 19433039) is also available
- Comes with 12.750" externally balanced 153-tooth automatic transmission flexplate. Requires externally balanced flywheel for manual transmission. See chart on page 157
- Requires fuel line from fuel pump to carburetor
- Some assembly and minor engine tuning required
- Not intended for marine applications

Mobil 1 is the recommended engine oil for all Chevrolet Performance Engines

TECH SPECS

Part Number:	19433040
Engine Type:	Chevy Small-Block V-8
Displacement (cu in):	350
Bore x Stroke (in):	4.000 x 3.480
Block (P/N 19431835):	Cast iron with 4-bolt main caps
Crankshaft (P/N 12670965):	Forged steel, shot peened
Connecting Rods (P/N 10108688):	Forged powder metal, shot peened
Pistons (P/N 10159436):	Hypereutectic aluminum
Intake Manifold (P/N 12366573):	Dual-plane aluminum
Camshaft Type (P/N 10185071):	Hydraulic roller
Valve Lift (in):	.474 intake / .510 exhaust
Camshaft Duration (@.050 in):	208° intake / 221° exhaust
Cylinder Heads (P/N 19417592):	Fast Burn aluminum; 62cc chambers
Valve Size (in):	2.000 intake / 1.550 exhaust
Compression Ratio:	9.7:1
Rocker Arms (P/N 10089648):	Stamped steel
Rocker Arm Ratio:	1.5:1
Recommended Fuel:	Premium pump
Ignition Timing:	36° Total @ 4,000 rpm
Maximum Recommended rpm:	5,800
Balanced:	External
Flexplate (P/N 14088765):	12.750"

NOTE: Distributor with melonized steel gear **MUST** be used with long-blocks and partial engines with steel camshafts, or engine damage will occur.



Chevrolet Performance Crate Engines include a 24-month or 50,000-mile/80,000-kilometer limited warranty, whichever comes first. See your GM dealer for details.



Chevrolet Performance **does not** utilize any used or remanufactured parts in this crate engine, except for the starter, alternator and power steering pump.



This part is intended for competition use only. See page 2 for complete details.

ADDITIONAL BUILD OPTIONS

19433039 

**SP350/385
Base**

Featuring all the same internals as the Turn-Key engine kit, this Base engine includes the intake manifold, distributor, water pump, damper and flexplate. Requires carburetor and additional accessories to complete.



19435619 

**SP350/ZZ6
Partial Engine**

The SP350 Partial is based on the popular ZZ6 engine assembly and includes a forged steel crankshaft, high-silicon pistons and durable connecting rods.



CONNECT & CRUISE CONFIGURATIONS

Chevrolet Performance's Connect & Cruise systems match our crate engines with transmissions for factory-tailored performance combinations—including supporting controllers and installation kit recommendations—that take the guesswork out of your project. See page 32 for more details.

SP350/385 Turn-Key with 4L65-E Automatic 

Engine:	19433040	Torque Converter:	19299801
Transmission:	19368611	Trans. Controller:	19332775
Install Kit:	19420473		

SP350/385 Turn-Key with Super Magnum Six-Speed Manual 

Engine:	19433040	Install Kit:	19329900
Transmission:	19352208		

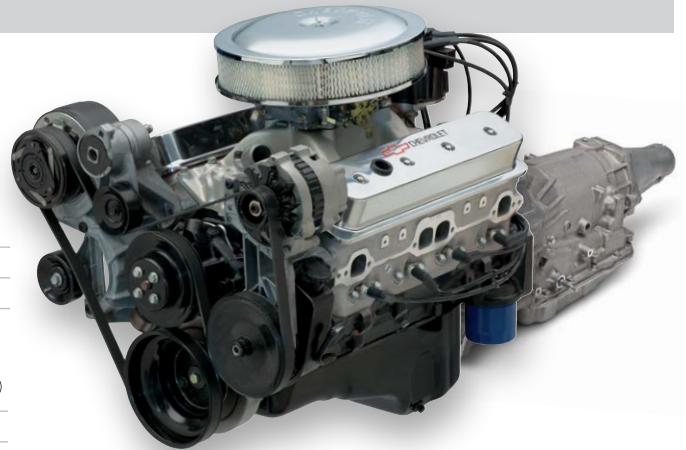

TRANSMISSION OPTIONS

See pages 20–31 for additional options.

19368611

SuperMatic™ 4L65-E Four-Speed Automatic (remanufactured)

Based on the 4L60-E, the 4L65-E electronically controlled four-speed automatic is rated for up to 430 lb.-ft. of torque. For strength, it features five-pinion gearsets, heat-treated stator shaft splines, an induction-hardened turbine shaft and more. See page 24 for more details.



19352208

Super Magnum Six-Speed Manual

This high-torque capacity TREMEC six-speed manual is designed for custom, retro-fit installations with Chevrolet Performance crate engines. It has a 700-lb.-ft. torque capacity and features a 40-tooth reluctor ring. See page 29 for more details.



ENGINE-RELATED PARTS & ACCESSORIES



**19433118
Transmission
Installation Kit**
page 25



**19329025
Bell Housing Kit**
page 29



**19299800
Torque
Converter**
page 22

ZZ6 Turn-Key

19433042 

405 hp

@ 5,600 rpm

406 lb.-ft.

@ 4,600 rpm

DYNO CHART

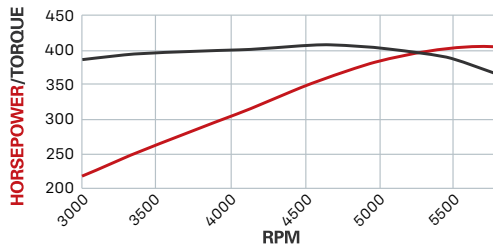

NOTE: Refer to page 6 for the complete horsepower and torque testing procedures.



Modern technology drives this classic 350 small-block!

Developed with contemporary technologies, including a high-rpm valvetrain, the ZZ6 Turn-Key offers a modern twist on the classic 350 Small-Block, delivering more than 400 horsepower and more than 400 lb.-ft. of torque!

The ZZ6 uses updated Fast Burn cylinder heads with beehive-style valve springs inspired by the LS engine family—a feature that enhances high-rpm capability to support more power than any factory-produced 350 engine ever installed in a Chevrolet production vehicle. The unique, tapered shape of the valve spring allows for the use of a smaller spring retainer, which reduces the reciprocating mass of the valvetrain, resulting in better valve dynamics.

The turn-key engine package includes the carburetor, distinctive valve covers and matching air cleaner, distributor, front-end accessory kit, starter, and spark plug wires (some installation required).

INSTALLATION NOTES

- Comes with 12.750" externally balanced 153-tooth automatic transmission flexplate. Requires externally balanced flywheel for manual transmission. See chart on page 157
- Requires fuel line to carburetor
- Some assembly and minor engine tuning required
- Not intended for marine applications

Mobil 1 is the recommended engine oil for all Chevrolet Performance Engines

TECH SPECS

Part Number:	19433042
Engine Type:	Chevy Small-Block
Displacement (cu in):	350
Bore x Stroke (in):	4.000 x 3.48
Block (P/N 19431835):	Cast iron with 4-bolt mains
Crankshaft (P/N 12670965):	Forged steel, shot peened
Connecting Rods (P/N 10108688):	Forged powder metal, shot peened
Pistons (P/N 10159436):	Hypereutectic aluminum
Intake Manifold (P/N 12496822):	Single plane aluminum
Carburetor (P/N 19420445):	770 cfm Holley
Camshaft Type (P/N 10185071):	Steel hydraulic roller
Valve Lift (in):	.474 intake/.510 exhaust
Camshaft Duration (@.050 in):	208° intake / 221° exhaust
Cylinder Heads (P/N 19417592):	Fast Burn aluminum; 62cc chambers
Valve Size (in):	2.000 intake / 1.550 exhaust
Compression Ratio:	9.7:1
Rocker Arms (P/N 19432297):	Aluminum roller style
Rocker Arm Ratio:	1.5:1
Recommended Fuel:	Premium pump
Distributor (P/N 19432312):	HEI
Ignition timing:	36° Total @ 4,000 rpm
Maximum Recommended rpm:	5,800 rpm
Balanced:	External
Flexplate (P/N 14088765):	12.750"

NOTE: Distributor with melonized steel gear **MUST** be used with long-blocks and partial engines with steel camshafts, or engine damage will occur.



Chevrolet Performance Crate Engines include a 24-month or 50,000-mile/80,000-kilometer limited warranty, whichever comes first. See your GM dealer for details.



Chevrolet Performance **does not** utilize any used or remanufactured parts in this crate engine, except for the starter, alternator and power steering pump.



This part is intended for competition use only. See page 2 for complete details.

ADDITIONAL BUILD OPTIONS

19433041 

ZZ6 Base

Like the ZZ6 Turn-Key, the ZZ6 Base features updated Fast Burn heads with beehive valve springs in an assembly that includes the intake manifold, distributor, water pump, damper and flexplate. Additional components required for assembly.



19435619 

SP350/ZZ6 Partial Engine

The SP350 Partial is based on the popular ZZ6 engine assembly and includes a forged steel crankshaft, high-silicon pistons and durable connecting rods.



CONNECT & CRUISE CONFIGURATIONS

Chevrolet Performance's Connect & Cruise systems match our crate engines with transmissions for factory-tailored performance combinations—including supporting controllers and installation kit recommendations—that take the guesswork out of your project. See page 32 for more details.

ZZ6 Turn-Key with 4L65-E Automatic 

Engine:	19433042	Torque Converter:	19299801
Transmission:	19368611	Controller:	19332775
Install Kit:	19420473		

ZZ6 Turn-Key with Super Magnum Six-Speed Manual 

Engine:	19433042	Install Kit:	19329900
Transmission:	19352208		



TRANSMISSION OPTIONS

See pages 20–31 for additional options.

19368611

SuperMatic™ 4L65-E Four-Speed Automatic (remanufactured)

Based on the 4L60-E, the 4L65-E electronically controlled four-speed automatic is rated for up to 430 lb.-ft. of torque. For strength, it features five-pinion gearsets, heat-treated stator shaft splines, an induction-hardened turbine shaft and more. Does not include converter. Use with electronic controller 19332775. See page 24 for more details.



ENGINE-RELATED PARTS & ACCESSORIES



19433448 
High-Torque Mini Starter

page 164



12497985
Aluminum Chrome Valve Covers

page 152



12480127
Short Aluminum Valve Covers

page 152



19299800
Torque Converter

page 22



19433118
Transmission Installation Kit

page 25



19332775
Transmission Controller

page 28



Parts intended for competition use only. See page 2 for details.



ZZ6 EFI Turn-Key

19433044 

420 hp

@ 5,800 rpm

408 lb.-ft.

@ 4,500 rpm

DYNO CHART

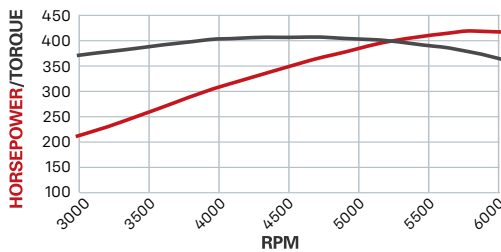

NOTE: Refer to page 6 for the complete horsepower and torque testing procedures.



> Includes Controller



Fuel-injected performance and convenience from the ZZ6!

The ZZ6 EFI Turn-Key builds on more than 65 years of Small-Block heritage and the legacy of the pioneering "ZZ" crate engine family to offer thoroughly modern performance balanced with traditional style.

Chevrolet Performance engineers adapted a unique, electronically controlled port fuel injection system to the ZZ6 350, using an aluminum intake manifold that has the appearance of a carbureted intake. A fuel injection throttle body mounted in place of the carburetor allows a traditional air cleaner to be installed. The result is a great, traditional appearance and all the drivability advantages of EFI on the highway.

A simple plug-and-play control system rounds out the package to get the engine running in your project without the need for third-party tuning. Our Turn-Key crate engine kit includes the distributor and damper installed. The throttle body, single-belt front-end accessory drive kit, and starter are also included (some installation required).

INSTALLATION NOTES

- Crate engine kit includes pre-programmed, self-learning control system
- Comes with 12.750" externally balanced 153-tooth automatic transmission flexplate. Requires externally balanced flywheel for manual transmission. See page 157 for more details.
- Not intended for marine applications

Mobil 1 is the recommended engine oil for all Chevrolet Performance Engines

TECH SPECS

Part Number:	19433044
Engine Type:	Chevy Small-Block V-8
Displacement (cu in):	350
Bore x Stroke (in):	4.000 x 3.480
Block (P/N 19431835):	Cast iron with 4-bolt main caps
Crankshaft (P/N 12670965):	Forged steel, shot peened
Connecting Rods (P/N 10108688):	Forged powder metal, shot peened
Pistons (P/N 10159436):	Hypereutectic aluminum
Camshaft Type (P/N 10185071):	Steel hydraulic roller
Valve Lift (in):	.474 intake / .510 exhaust
Camshaft Duration (@.050 in):	208° intake / 221° exhaust
Cylinder Heads (P/N 19417592):	Fast Burn aluminum; 62cc chambers
Valve Size (in):	2.000 intake / 1.550 exhaust
Compression ratio:	9.7:1
Rocker Arms (P/N 19432297):	Aluminum; roller-style
Rocker Arm Ratio:	1.5:1
Recommended Fuel:	Premium pump
Ignition Timing:	36° total @ 4,000 rpm
Maximum Recommended RPM:	5,800
Balanced:	External
Flexplate (P/N 14088765):	12.750"

NOTE: Distributor with melonized steel gear **MUST** be used with long-blocks and partial engines with steel camshafts, or engine damage will occur.



Chevrolet Performance Crate Engines include a 24-month or 50,000-mile/80,000-kilometer limited warranty, whichever comes first. See your GM dealer for details.



Chevrolet Performance **does not** utilize any used or remanufactured parts in this crate engine, except for the starter, alternator and power steering pump.



This part is intended for competition use only. See page 2 for complete details.

ADDITIONAL BUILD OPTIONS

19433043 

ZZ6 EFI Deluxe

Like the ZZ6 EFI Turn-Key, the ZZ6 EFI Base features the throttle body, fuel rail and injectors, as well as the control system. Also included are the intake manifold, distributor, water pump, damper and flexplate. Additional components required for assembly.



NOTE: Ignition wire set P/N 19433385 (shown) not included in the Deluxe engine kit but can be ordered separately.

19435619 

SP350/ZZ6 Partial Engine

The SP350 Partial is based on the popular ZZ6 engine assembly and includes a forged steel crankshaft, high-silicon pistons and durable connecting rods.



CONNECT & CRUISE CONFIGURATIONS

Chevrolet Performance's Connect & Cruise systems match our crate engines with transmissions for factory-tailored performance combinations—including supporting controllers and installation kit recommendations—that take the guesswork out of your project. See page 32 for more details.

ZZ6 EFI Turn-Key with 4L65-E Automatic 

Engine:	19433044 + 19419371	Install Kit:	19420473
Engine Controller:	included w/engine	Torque Converter:	19299801
Transmission:	19368611	Trans. Controller:	19332775

ZZ6 EFI Deluxe with 4L65-E Automatic 

Engine:	19433043 + 19419371	Install Kit:	19420473
Engine Controller:	included w/engine	Torque Converter:	19299801
Transmission:	19368611	Trans. Controller:	19332775

ZZ6 EFI Turn-Key with Super Magnum Six-Speed Manual 

Engine:	19433044	Install Kit:	19329900
Transmission:	19352208		



ZZ6 EFI Deluxe with Super Magnum Six-Speed Manual 

Engine:	19433043	Install Kit:	19329900
Transmission:	19352208		

TRANSMISSION OPTIONS

See pages 20–31 for additional options.

19368611

SuperMatic™ 4L65-E Four-Speed Automatic (remanufactured)

Based on the 4L60-E, the 4L65-E electronically controlled four-speed automatic is rated for up to 430 lb.-ft. of torque. For strength, it features five-pinion gearsets, heat-treated stator shaft splines, an induction-hardened turbine shaft and more. See page 24 for more details.



19352208

Super Magnum Six-Speed Manual

This high-torque capacity TREMEC six-speed manual is designed for custom, retro-fit installations with Chevrolet Performance crate engines. It has a 700-lb.-ft. torque capacity and features a 40-tooth reluctor ring. See page 29 for more details.

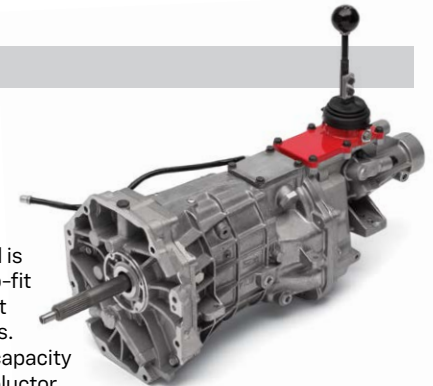

ENGINE-RELATED PARTS & ACCESSORIES



19332775
Transmission Controller

page 28



19433118
Transmission Installation Kit

page 25



19299800
Torque Converter

page 22



Parts intended for competition use only. See page 2 for details.



Performance

HT383

19433036 
323 hp

@ 4,200 rpm

444 lb.-ft.

@ 3,000 rpm

DYNO CHART

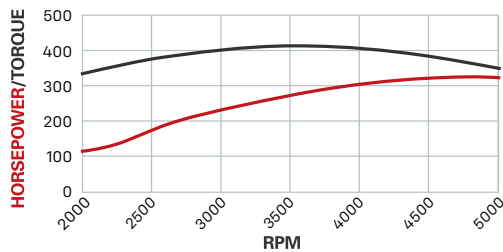

NOTE: Refer to page 6 for the complete horsepower and torque testing procedures.



Upgrade your small-block's torque!

Ready for a replacement? Forget the rebuild and take your vehicle's capability to the next level with our big-torque HT383 crate engine. Its extra displacement and unique parts are designed to deliver a wide, flat torque curve that maintains at least 400 lb.-ft. between 2,500 and 4,000 rpm, with peak torque of 444 lb.-ft.!

That's serious pulling power—and power that won't come with a stock-type rebuild. The HT383 features a brand-new engine block with four-bolt mains (a strength-enhancing upgrade for most production engines, which came with two-bolt mains) along with a forged steel crankshaft (which includes a 4X crankshaft position sensor), and more. We deliver the HT383 with an aluminum intake manifold, ready for you to swap over the accessories from your tired engine. It's also backed by a 24-month/50,000-mile (80,000 km) limited warranty. See your dealer for complete details.

The HT383 is also available as a partial engine. See details at right.

INSTALLATION NOTES

- Requires addition of carburetor, fuel pump, ignition system and starter (not included)
- Rochester Quadrajets or Holley 670-cfm carburetor recommended
- Comes with 12.750" externally balanced 153-tooth automatic transmission flexplate. Requires externally balanced flywheel for manual transmission. See chart on page 157
- Has right-side oil dipstick
- Not intended for marine applications

Mobil 1 is the recommended engine oil for all Chevrolet Performance Engines

TECH SPECS

Part Number:	19433036
Engine Type:	Chevy Small-Block V-8
Displacement (cu in):	383
Bore x Stroke (in):	4.005 x 3.800
Block (P/N 19433406):	Cast iron with 4-bolt main caps
Crankshaft (P/N 12489436):	4340 forged steel; includes 4X crankshaft position sensor
Connecting Rods (P/N 19355718):	Heavy-duty forged steel
Pistons (P/N 12499103):	Hypereutectic aluminum
Intake Manifold (P/N 12496820):	Dual plane aluminum
Camshaft Type (P/N 14097395):	Hydraulic roller
Valve Lift (in):	.431 intake / .451 exhaust
Camshaft Duration (@.050 in):	196° intake / 206° exhaust
Cylinder Heads (P/N 12691728):	Vortec iron; 62cc chambers
Valve Size (in):	1.940 intake / 1.500 exhaust
Compression Ratio:	9.4:1
Rocker Arms (P/N 10089648):	Stamped steel
Rocker Arm Ratio:	1.5:1
Water Pump (P/N 12685965):	Cast iron
Recommended Fuel:	Regular pump
Ignition Timing:	32° Total @ 4,000 rpm
Maximum Recommended rpm:	5,000
Balanced:	External
Flexplate (P/N 14088765):	12.750"

NOTE: Distributor with melonized steel gear **MUST** be used with long-blocks and partial engines with steel camshafts, or engine damage will occur.



Chevrolet Performance Crate Engines include a 24-month or 50,000-mile/80,000-kilometer limited warranty, whichever comes first. See your GM dealer for details.



Chevrolet Performance **does not** utilize any used or remanufactured parts in this crate engine, except for the starter, alternator and power steering pump.



This part is intended for competition use only. See page 2 for complete details.

ADDITIONAL BUILD OPTIONS

19435620 **383 Partial Engine**

This partial engine assembly has the heart of the HT383, including a forged steel crankshaft set in a brand-new four-bolt-mains block, along with heavy-duty connecting rods and durable aluminum-alloy pistons. Requires additional components for completion.

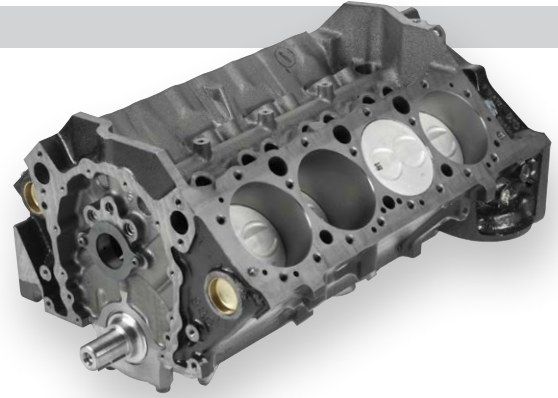

TRANSMISSION OPTIONS

See pages 20–31 for additional options.

19368613

SuperMatic™ 4L70-E Four-Speed Automatic (remanufactured)

Based on the 4L60-E, the 4L70-E electronically controlled four-speed automatic is rated for up to 495 lb.-ft. of torque. For strength, it features five-pinion gearsets, heat-treated stator shaft splines, an induction-hardened turbine shaft and more, including a unique valve body calibration. Does not include converter. Use with electronic controller P/N 19332775. See page 24 for more details.



ENGINE-RELATED PARTS & ACCESSORIES



19433118

Transmission Installation Kit

page 25



19332775

Transmission Controller

page 28



19299800

Torque Converter

page 22

19420450 

Carburetor – Holley 670-cfm

page 165



12497985

Aluminum Chrome Valve Covers

page 152

19432312 

HEI Distributor

page 160



Parts intended for competition use only.
See page 2 for details.



Performance

129

HT383E

19435449 

323 hp

@ 4,200 rpm

444 lb.-ft.

@ 3,000 rpm

- > **GREATER TORQUE**
- > **BETTER ALTERNATIVE TO A REBUILD**
- > **INCLUDES ALL NEW PARTS**

NOTE: Refer to page 6 for the complete horsepower and torque testing procedures.



A big-torque bolt-in for trucks

When it comes to breathing new life into your trusted truck, the HT383E delivers. If you are going to go off-road racing or hill-climbing with your old half-ton truck, the HT383E provides a great boost in horsepower and torque, compared to the original small-block 350 that came from the factory. To make the installation easy and economical, you can simply swap the intake manifold, throttle body, exhaust manifolds and other engine accessories from the original 350 engine. The engine uses a brand-new four-bolt-main iron block, a forged steel stroker crankshaft (including a 4X crankshaft position sensor), a smooth roller camshaft and durable cast-iron Vortec-style cylinder heads. It comes with a new water pump and a vibration dampener that would normally be replaced during a complete rebuild of your original engine.

Save money and enjoy increased power and torque when you choose the HT383E crate engine, designed and tested by Chevrolet Performance engineers.

INSTALLATION NOTES

- Requires the reuse of the stock intake manifold, distributor, wiring harness and fuel injection system
- Due to calibration variances between half-, three-quarter- and one-ton vehicles, this engine is designed for half-ton trucks and SUVs only
- Comes with 12.750" externally balanced 153-tooth automatic transmission flexplate. Requires externally balanced flywheel for manual transmission. See chart on page 157
- Has right-side dipstick
- Not available as a partial engine

Mobil 1 is the recommended engine oil for all Chevrolet Performance Engines

TECH SPECS

Part Number:	19435449
Engine Type:	Chevy Small-Block V-8
Displacement (cu in):	383
Bore x Stroke (in):	4.005 x 3.800
Block (P/N 19433406):	Cast iron with 4-bolt main caps
Crankshaft (P/N 12489436):	4340 forged steel; includes 4X crankshaft position sensor
Connecting Rods (P/N 19355718):	Heavy-duty forged steel
Pistons (P/N 12499103):	Hypereutectic aluminum
Camshaft Type (P/N 14097395):	Hydraulic roller
Valve Lift (in):	.431 intake / .451 exhaust
Camshaft Duration (@.050 in):	196° intake / 206° exhaust
Cylinder Heads (P/N 12691728):	Vortec iron; 62cc chambers
Valve Size (in):	1.940 intake / 1.500 exhaust
Compression Ratio:	9.4:1
Rocker Arms (P/N 10089648):	Stamped steel
Rocker Arm Ratio:	1.5:1
Water Pump (P/N 89060527):	Cast iron
Recommended Fuel:	Regular pump
Maximum Recommended rpm:	5,000
Balanced:	External
Flexplate (P/N 14088765):	12.750"

NOTE: Distributor with melonized steel gear **MUST** be used with long-blocks and partial engines with steel camshafts, or engine damage will occur.



Chevrolet Performance Crate Engines include a 24-month or 50,000-mile/80,000-kilometer limited warranty, whichever comes first. See your GM dealer for details.



Chevrolet Performance **does not** utilize any used or remanufactured parts in this crate engine, except for the starter, alternator and power steering pump.



This part is intended for competition use only. See page 2 for complete details.

TRANSMISSION OPTIONS

See pages 20–31 for additional options.

19368613

SuperMatic™ 4L70-E Four-Speed Automatic (remanufactured)

Based on the 4L60-E, the 4L70-E electronically controlled four-speed automatic is rated for up to 495 lb.-ft. of torque. For strength, it features five-pinion gearsets, heat-treated stator shaft splines, an induction-hardened turbine shaft and more. See page 24 for more details.

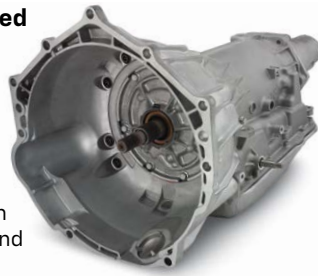

19352208

Super Magnum Six-Speed Manual

This high-torque capacity TREMEC six-speed manual is designed for custom, retro-fit installations with Chevrolet Performance crate engines. It has a 700-lb.-ft. torque capacity and features a 40-tooth reluctor ring. See page 29 for more details.

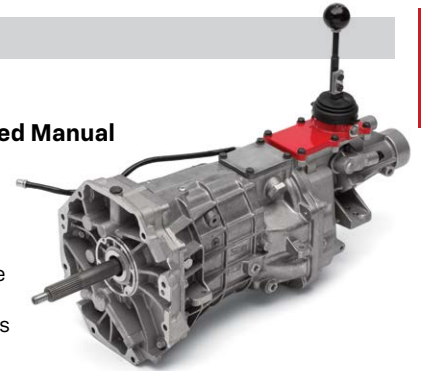

ENGINE-RELATED PARTS & ACCESSORIES

19433118
Transmission Installation Kit

page 25

19329025
Bell Housing Kit

page 29

19332775
Transmission Controller

page 28

19299800
Torque Converter

page 22

19432298
Roller Rocker Arm Set – 1.5:1 Ratio

page 151

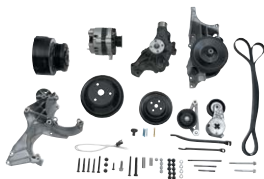
19435736
Serpentine Accessory Drive System

page 159

12366573 
Dual-Plane Intake Manifold

page 161

12497979
Aluminum Black Crinkle Valve Covers

page 152

 BUILDER'S TIP**HT383E Installation**

The HT383E assembly is very complete, but requires a number of parts from the truck's original 350 engine to be transferred to it. Optimizing the changeover should include a number of supporting steps and procedures, including:

- Using all-new intake manifold and exhaust manifold gaskets. RTV-type sealant is required for the front and rear of the intake manifold
- Inspection of the original serpentine belt. Replace if it appears worn, cracked or glazed
- If the original engine had high miles, consider replacing the accessory drive system's tensioner
- Inspect the original power steering pump for signs of leaks prior to reinstallation
- Install a new air filter element
- Priming the HT383E with oil **MUST** be done prior to starting it for the first time
- Engine timing is not externally adjustable with the HT383E. The original engine controller makes all timing adjustments
- Change the oil after the break-in and inspect the filter for foreign particles. Change the oil again after the first 500 miles and check the filter again for foreign particles



Parts intended for competition use only.
See page 2 for details.



Performance

131

SP383 Turn-Key

19435452 

435 hp

@ 5,600 rpm

445 lb.-ft.

@ 4,600 rpm

DYNO CHART

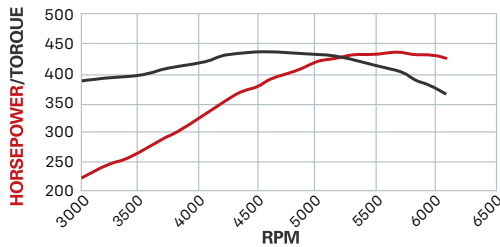

NOTE: Refer to page 6 for the complete horsepower and torque testing procedures.



Modern technology adds range to the 383 stroker!

Chevrolet Performance's SP383 Turn-Key uses LS-inspired valvetrain technology to expand its rpm range, matching the stroker combination's traditional torque with more high-rpm horsepower. Lightweight aluminum cylinder heads based on the proven Fast Burn design are at the heart of the SP383's performance capability. They feature beehive-style valve springs to enable great high-rpm performance and durability, allowing the SP383 to rev higher and build more horsepower.

Additionally, the engine features a forged steel stroker crankshaft, an aggressive hydraulic roller camshaft and a high-flow aluminum single-plane intake manifold — and as a Chevrolet Performance Turn-Key Engine, it comes with the intake manifold and distributor installed. It also includes the carburetor, front-end accessory kit, crankshaft balancer, chrome air cleaner, starter, water pump and spark plug wires (some installation required).

INSTALLATION NOTES

- Requires an externally balanced flexplate for automatic transmission or an externally balanced flywheel for manual transmission. See chart on page 157
- Requires fuel line from fuel pump to carburetor
- Some assembly and minor engine tuning required
- Not intended for marine applications

Mobil 1 is the recommended engine oil for all Chevrolet Performance Engines

TECH SPECS

Part Number:	19435452
Engine Type:	Chevy Small-Block V-8
Displacement (cu in):	383
Bore x Stroke (in):	4.005 x 3.800
Block (P/N 19432109):	Cast iron with 4-bolt main caps
Crankshaft (P/N 12489436):	Forged steel
Connecting Rods (P/N 19355754):	Heavy-duty forged steel
Pistons (P/N 12499103):	Hypereutectic aluminum
Intake Manifold (P/N 12496822):	Single-plane aluminum
Camshaft Type (P/N 19210723):	Hydraulic roller
Valve Lift (in):	.509 intake / .528 exhaust
Camshaft Duration (@.050 in):	222° intake / 230° exhaust
Cylinder Heads (P/N 19417592):	Fast Burn aluminum; 62cc chambers
Valve Size (in):	2.000 intake / 1.550 exhaust
Compression Ratio:	9.9:1
Rocker Arms (P/N 19432297):	Aluminum roller style
Rocker Arm Ratio:	1.5:1
Recommended Fuel:	Premium pump
Ignition Timing:	36° Total at 4,000 rpm
Maximum Recommended rpm:	6,000
Balanced:	External
Flexplate (P/N 14088765):	12.750"

NOTE: Distributor with melonized steel gear **MUST** be used with long-blocks and partial engines with steel camshafts, or engine damage will occur.



Chevrolet Performance Crate Engines include a 24-month or 50,000-mile/80,000-kilometer limited warranty, whichever comes first. See your GM dealer for details.



Chevrolet Performance **does not** utilize any used or remanufactured parts in this crate engine, except for the starter, alternator and power steering pump.



This part is intended for competition use only. See page 2 for complete details.

ADDITIONAL BUILD OPTIONS



19433035

SP383 Deluxe

Like the Turn-Key crate engine, the SP383 Deluxe is rated at 435 horsepower and 445 lb.-ft. of torque. It comes with the crankshaft balancer, intake manifold, carburetor and distributor installed.



19435450

SP383 Base

All the same important, power-building elements as the Turn-Key and Deluxe versions, but it comes without a crankshaft balancer, intake manifold, carburetor, water pump or distributor.



19435620

383 Partial Engine

This partial engine assembly has the heart of the HT383, including a forged steel crankshaft set in a brand-new four-bolt-mains block, along with heavy-duty connecting rods and durable aluminum-alloy pistons.

CONNECT & CRUISE CONFIGURATIONS

Chevrolet Performance's Connect & Cruise systems match our crate engines with transmissions for factory-tailored performance combinations—including supporting controllers and installation kit recommendations—that take the guesswork out of your project. See page 32 for more details.

SP383 Turn-Key with 4L70-E Automatic

Engine:	19435452	Torque Converter:	19299801
Transmission:	19368613	Trans. Controller:	19332775
Install Kit:	19420473		

SP383 Turn-Key with Super Magnum Six-Speed Manual

Engine:	19435452	Install Kit:	19329900
Transmission:	19352208		



TRANSMISSION OPTIONS

See pages 20–31 for additional options.

19368613

SuperMatic™ 4L70-E Four-Speed Automatic (remanufactured)

Based on the 4L60-E, the 4L70-E electronically controlled four-speed automatic is rated for up to 495 lb.-ft. of torque. For strength, it features five-pinion gearsets, heat-treated stator shaft splines, an induction-hardened turbine shaft and more. See page 24 for more details.



19352208

Super Magnum Six-Speed Manual

This high-torque capacity TREMEC six-speed manual is designed for custom, retro-fit installations with Chevrolet Performance crate engines. It has a 700-lb.-ft. torque capacity and features a 40-tooth reluctor ring. See page 29 for more details.

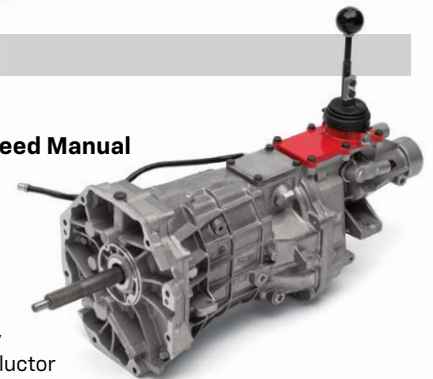

ENGINE-RELATED PARTS & ACCESSORIES



19299801
Torque Converter

page 22



19332775
Transmission Controller

page 28



19420445
Carburetor –
Holley 770-cfm

page 165



Parts intended for competition use only.
See page 2 for details.



Performance

133

SP383 EFI Turn-Key

19433046 

450 hp

@ 5,800 rpm

436 lb.-ft.

@ 4,800 rpm

DYNO CHART

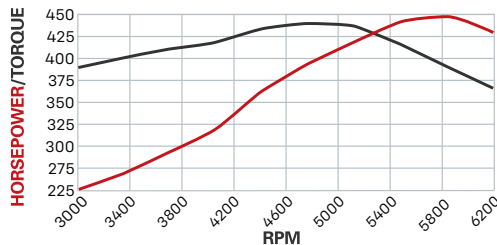

NOTE: Refer to page 6 for the complete horsepower and torque testing procedures.



Big torque and EFI performance in a comprehensive kit

Chevrolet Performance's SP383 EFI Turn-Key kit offers the strong pull of the proven 383 "stroker" combination and the contemporary convenience of electronic fuel injection, delivered with most of the engine accessories required to get the engine running in your project vehicle!

The SP383 EFI incorporates a port-style injection system, with the injectors plumbed in a carburetor-style intake manifold, and the throttle body mounted in the conventional position of the carburetor, which allows for a traditional air cleaner and a classic appearance. Our comprehensive Turn-Key assembly is delivered with the distributor and damper installed. The throttle body, air conditioning pump, alternator, single-belt front-end accessory drive system and more are also included in the kit. The engine controller is also included.

INSTALLATION NOTES

- Crate engine kit includes pre-programmed, self-learning control system
- Comes with a 12.750" externally balanced 153-tooth automatic transmission flexplate. An externally balanced flywheel is required for manual transmission applications. See chart on page 157
- Not intended for marine applications

TECH SPECS

Part Number:	19433046
Engine Type:	Chevy Small-Block V-8
Displacement (cu in):	383
Bore x Stroke (in):	4.005 x 3.800
Block (P/N 19432109):	Cast iron with 4-bolt main caps
Crankshaft (P/N 12489436):	Forged steel
Connecting Rods (P/N 19355754):	Heavy-duty forged steel
Pistons (P/N 12499103):	Hypereutectic aluminum
Camshaft Type (P/N 19210723):	Steel hydraulic roller
Valve Lift (in):	.509 intake / .528 exhaust
Camshaft Duration (@.050 in):	220° intake / 230° exhaust
Cylinder Heads (P/N 19417592):	Fast Burn aluminum; 62cc chambers
Valve Size (in):	2.000 intake / 1.550 exhaust
Compression Ratio:	9.9:1
Rocker Arms (P/N 19432297):	Aluminum roller style
Rocker Arm Ratio:	1.5:1
Recommended Fuel:	Premium pump
Ignition Timing:	36° Total at 4,000 rpm
Maximum Recommended rpm:	6,000
Balanced:	External
Flexplate (P/N 14088765):	12.750"

NOTE: Distributor with melonized steel gear **MUST** be used with long-blocks and partial engines with steel camshafts, or engine damage will occur.

Mobil 1 is the recommended engine oil for all Chevrolet Performance Engines



Chevrolet Performance Crate Engines include a 24-month or 50,000-mile/80,000-kilometer limited warranty, whichever comes first. See your GM dealer for details.



Chevrolet Performance **does not** utilize any used or remanufactured parts in this crate engine, except for the starter, alternator and power steering pump.



This part is intended for competition use only. See page 2 for complete details.

ADDITIONAL BUILD OPTIONS

19433045 

SP383 EFI Deluxe

All of the same internal components and EFI system (including controller) as the SP383 EFI Turn-Key kit, but without a number of the accessories. Kit includes the distributor, water pump, damper and flexplate.



19435620 

383 Partial Engine

This partial engine assembly has the heart of the HT383, including a forged steel crankshaft set in a brand-new four-bolt mains block, along with heavy-duty connecting rods and durable aluminum-alloy pistons.



CONNECT & CRUISE CONFIGURATIONS

Chevrolet Performance's Connect & Cruise systems match our crate engines with transmissions for factory-tailored performance combinations—including supporting controllers and installation kit recommendations—that take the guesswork out of your project. See page 32 for more details.

SP383 EFI Turn-Key with 4L70-E Automatic 

Engine:	19433046 + 19419371	Install Kit:	19420473
Engine Controller:	<i>included w/engine</i>	Torque Converter:	19299800
Transmission:	19368613	Controller:	19332775

SP383 EFI Deluxe with 4L70-E Automatic 

Engine:	19433045 + 19419371	Install Kit:	19420473
Engine Controller:	<i>included w/engine</i>	Torque Converter:	19299800
Transmission:	19368613	Controller:	19332775

SP383 EFI Turn-Key with Super Magnum Six-Speed Manual 

Engine:	19433046	Install Kit:	19329900
Transmission:	19352208		



SP383 EFI Deluxe with Super Magnum Six-Speed Manual 

Engine:	19433045	Install Kit:	19329900
Transmission:	19352208		

TRANSMISSION OPTIONS

See pages 20–31 for additional options.

19368613

SuperMatic™ 4L70-E Four-Speed Automatic (remanufactured)

Based on the 4L60-E, the 4L70-E electronically controlled four-speed automatic is rated for up to 495 lb.-ft. of torque. For strength, it features five-pinion gearsets, heat-treated stator shaft splines, an induction-hardened turbine shaft and more. See page 24 for more details.



19352208

Super Magnum Six-Speed Manual

This high-torque capacity TREMEC six-speed manual is designed for custom, retro-fit installations with Chevrolet Performance crate engines. It has a 700-lb.-ft. torque capacity and features a 40-tooth reluctor ring. See page 29 for more details.

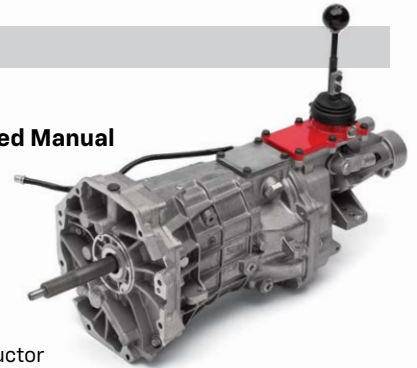

ENGINE-RELATED PARTS & ACCESSORIES



19433118
Transmission Installation Kit

page 25



19299801
Torque Converter

page 22



19332775
Transmission Controller

page 28



Parts intended for competition use only. See page 2 for details.



Performance



Circle Track Crate Engines

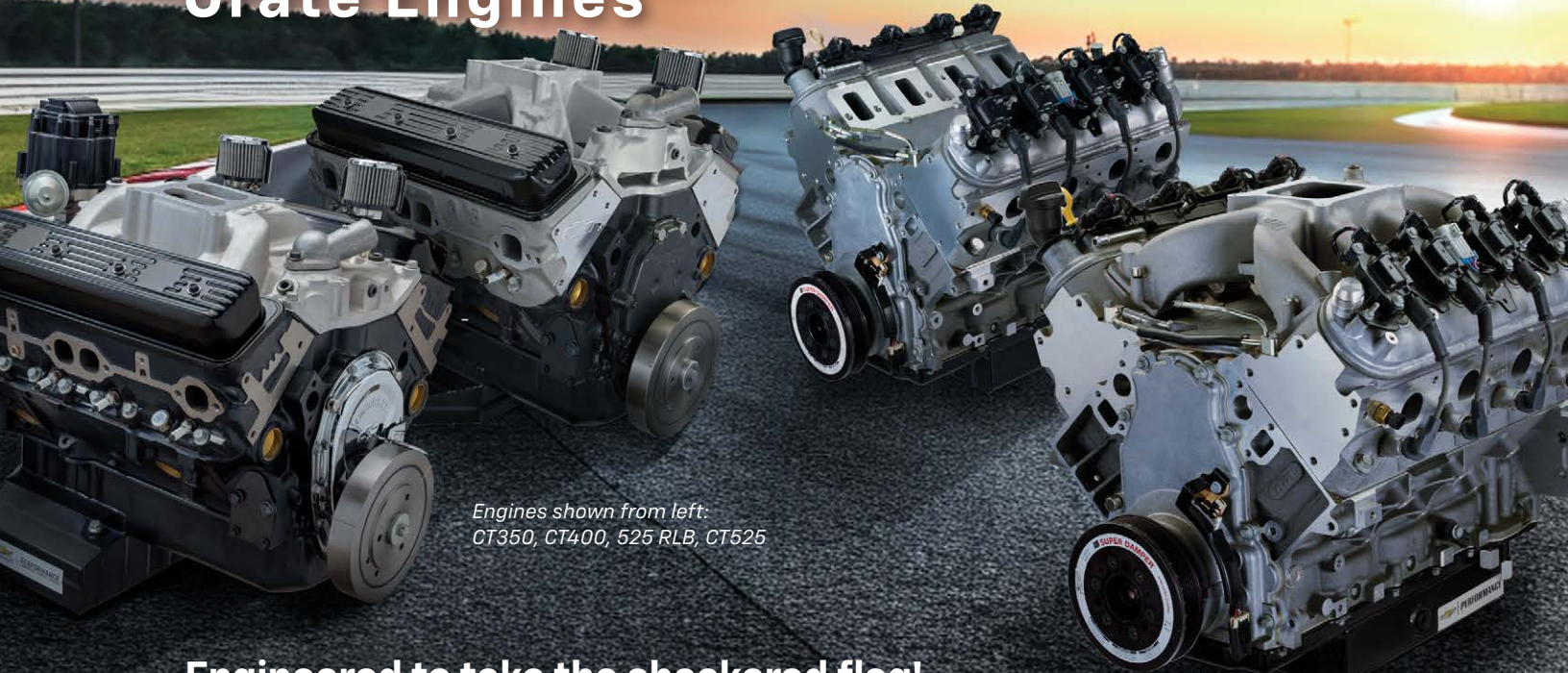

Engines shown from left:
CT350, CT400, 525 RLB, CT525

Engineered to take the checkered flag!

There's more to capturing the checkered flag than horsepower. Week after week and season after season, you need lasting performance — and that's exactly what you can depend on with Chevrolet Performance Circle Track crate engines.

Each package is built with brand-new parts and our CT400 Small-Block engine features a new block with four-bolt mains — a strength-enhancing feature you won't find on most used blocks. And when it comes to big power, our LS-based CT525 is rated at 533 horsepower, and our 525 Racing Long Block delivers the same high-performance foundation as the crate engine, but in a partial assembly to be finished by the builder.

Check out the following pages to find the Chevrolet Performance Circle Track engine that's right for you!

CT350	137
CT400	138
CT525	139
525 RLB.....	140

NOTE: Engines may not come with all the parts shown in photo. See your dealer for more details.

TECH MANUALS

19434342 Circle Track Techbook

- Technical manual for GM Circle Track crate engines CT350 and CT400
- Covers all details regarding rebuilding specifications, including parts lists
- 47 pages with photos and details on valve machining, valve springs, camshafts and other factory specifications



19434343 Circle Track Techbook (CT525)

- Technical manual for Chevrolet Performance CT525 Circle Track engine
- Covers all engine specifications, component part numbers, installation tips and rebuilding specifications



CT350

19435602 

350 hp

@ 5,400 rpm

396 lb.-ft.

@ 3,800 rpm

DYNO CHART

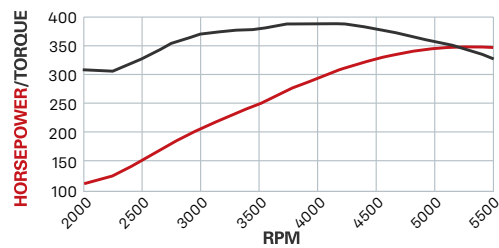

NOTE: Refer to page 6 for the complete horsepower and torque testing procedures.



An affordable, proven winner!

Chevrolet Performance's durable CT350 is the budget-conscious crate engine racers can depend on for competitive performance and low maintenance—and with 350 horsepower, it's the perfect match for many short-track series.

The CT350 is based on our popular 350 HO high-performance street-class crate engine and features a strong four-bolt-main block and iron Vortec cylinder heads. A unique dual-pattern camshaft helps deliver almost 400 lb.-ft. of torque between 2,000 and 5,500 rpm—peaking at 396 lb.-ft. at 3,800 rpm. With that much pulling power, you can hold a gear longer, keeping the engine in its sweet spot for quicker laps.

We assemble the CT350 with an 8-quart circle track racing oil pan, balancer, HEI distributor and an aluminum high-rise, dual-plane intake manifold. Add your carburetor, starter, wires and water pump—all available from Chevrolet Performance—and you'll be ready for the green flag!

INSTALLATION NOTES

- Requires addition of carburetor, starter, water pump, plug wires and exhaust system (not included)
- Requires an externally balanced flywheel (not included). See page 157 for flywheel selection
- The 8-quart circle track oil pan is 8 inches deep at the sump. It will clear most GM rear-steer chassis with stock engine location
- For circle track racing only—not intended for street use
- Circle Track racing engines from Chevrolet Performance include anti-tampering seals installed

 is the recommended engine oil for all Chevrolet Performance Engines

TECH SPECS

Part Number:	19435602
Engine Type:	Chevy Small-Block V-8
Displacement (cu in):	350
Bore x Stroke (in):	4.000 x 3.480
Block (P/N 19431835):	Cast iron with 4-bolt main caps
Crankshaft (P/N 12691722):	Forged Steel
Connecting Rods (P/N 19435115):	Forged powder metal, shot peened
Pistons (P/N 88894280):	Hypereutectic aluminum
Intake Manifold (P/N 12366573):	Dual-plane aluminum
Camshaft Type (P/N 24502476):	Hydraulic flat tappet
Valve Lift (in):	.435 intake / .460 exhaust
Camshaft Duration (@.050 in):	212° intake / 222° exhaust
Cylinder Heads (P/N 12691728):	Vortec iron; 62cc chambers
Valve Size (in):	1.940 intake / 1.500 exhaust
Compression Ratio:	9.6:1
Rocker Arms (P/N 10089648):	Stamped steel
Rocker Arm Ratio:	1.5:1
Recommended Fuel:	Premium pump
Ignition Timing:	34° Total @ 4,000 rpm
Maximum Recommended rpm:	5,500
Balanced:	External

NOTE: Distributor with melonized steel gear **MUST** be used with long-blocks and partial engines with steel camshafts, or engine damage will occur.

 This Chevrolet Performance Racing Crate Engine is purpose-built for racing only, and has no warranty.

 Chevrolet Performance does not utilize any used or remanufactured parts in this crate engine, except for the starter, alternator and power steering pump.

 This part is intended for competition use only. See page 2 for complete details.

CT400

19435604 

404 hp

@ 5,600 rpm

406 lb.-ft.

@ 4,600 rpm

DYNO CHART

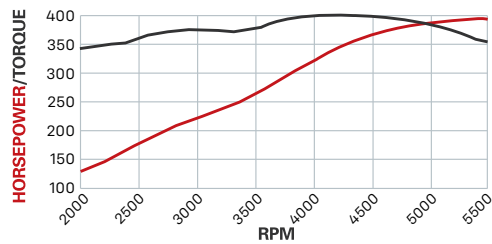

NOTE: Refer to page 6 for the complete horsepower and torque testing procedures.



High-revving performance lap after lap

Chevrolet Performance's high-revving CT400 racing crate engine uses aluminum Fast Burn cylinder heads with LS-style beehive valve springs to enable greater high-rpm performance and durability. They allow the engine to rev higher to make the most of every cubic inch of air drawn through it, helping it produce 404 horsepower at 5,600 rpm and 406 lb.-ft. of torque at 4,600 rpm.

The CT400 also has a tough bottom end, anchored by a forged steel crankshaft and strong aluminum pistons installed in a brand-new block with four-bolt mains. It also features a racing oil pan and a single-plane aluminum intake manifold. Add your carburetor and other finishing components to get the CT400 running in your race car, so you can chase the checkered flag!

INSTALLATION NOTES

- Requires addition of carburetor, starter, ignition, plug wires, water pump, distributor and exhaust system (not included)
- Requires an externally balanced flywheel (not included). See page 157 for flywheel selection
- The 8-quart circle track oil pan is 7 inches deep at the sump. It will clear most GM rear-steer chassis with stock engine location
- For circle track racing only—not intended for street use
- Circle Track racing engines from Chevrolet Performance include anti-tampering seals installed

Mobil 1 is the recommended engine oil for all Chevrolet Performance Engines

TECH SPECS

Part Number:	19435604
Engine Type:	Chevy Small-Block V-8
Displacement (cu in):	350
Bore x Stroke (in):	4.000 x 3.480
Block (P/N 19431835):	Cast iron with 4-bolt main caps
Crankshaft (P/N 12670965):	Forged steel, shot peened
Connecting Rods (P/N 19435115):	Forged powder metal, shot peened
Pistons (P/N 19434034):	Hypereutectic aluminum
Intake Manifold (P/N 12496822):	Single-plane aluminum
Camshaft Type (P/N 10185071):	Steel hydraulic roller
Valve Lift (in):	.474 intake / .510 exhaust
Camshaft Duration (@.050 in):	208° intake / 221° exhaust
Cylinder Heads (P/N 19417592):	Fast Burn aluminum; 62cc chambers
Valve Size (in):	2.000 intake / 1.550 exhaust
Compression Ratio:	9.7:1
Rocker Arms (P/N 19210724):	Aluminum; roller style
Rocker Arm Ratio:	1.5:1
Recommended Fuel:	Premium pump
Ignition Timing:	36° Total @ 4,000 rpm
Maximum Recommended rpm:	5,800
Balanced:	External

NOTE: Distributor with melonized steel gear **MUST** be used with long-blocks and partial engines with steel camshafts, or engine damage will occur.



This Chevrolet Performance Racing Crate Engine is purpose-built for racing only, and has no warranty.



Chevrolet Performance **does not** utilize any used or remanufactured parts in this crate engine, except for the starter, alternator and power steering pump.



This part is intended for competition use only. See page 2 for complete details.

CT525

19434598 

533 hp

@ 6,600 rpm

477 lb.-ft.

@ 5,200 rpm

DYNO CHART

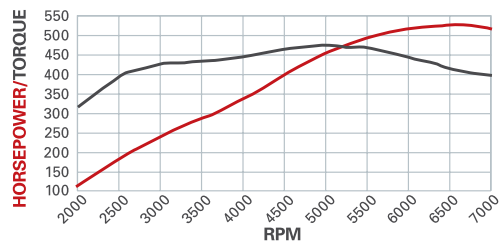

NOTE: Refer to page 6 for the complete horsepower and torque testing procedures.

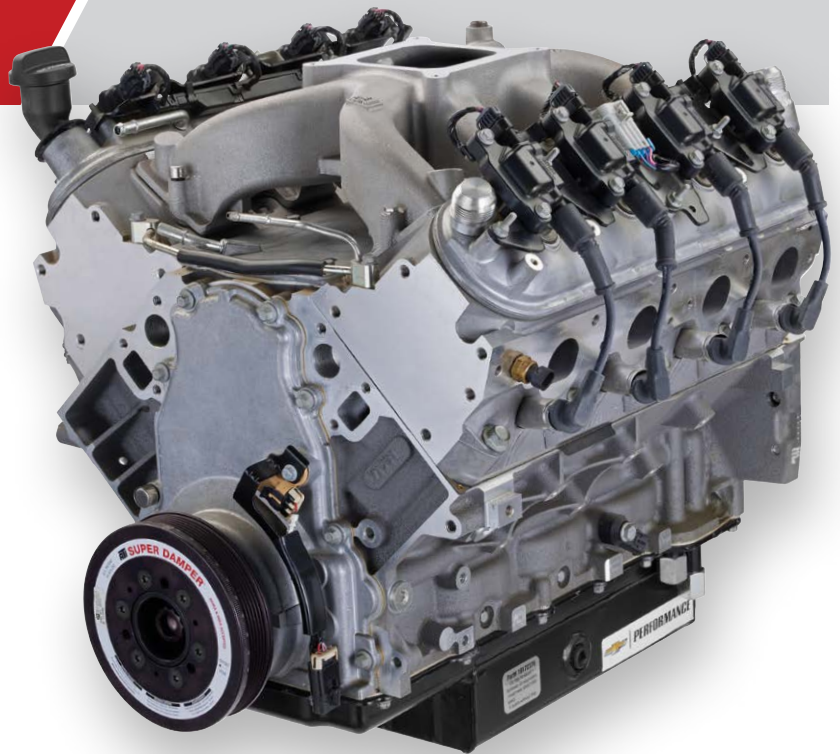

High-RPM LS performance with forged pistons

Chevrolet Performance's deep-breathing, high-revving CT525 6.2L crate engine is assembled with strong forged pistons designed to support its performance capability and enhance its durability.

The CT525 is based on the LS engine family and is similar to the 6.2L LS3, but we've adapted it to circle track racing with a carbureted intake manifold, 6-quart racing oil pan, heavy-duty engine bearings and more. It's a combination rated at 533 horsepower at 6,600 rpm and a strong 477 lb.-ft. of torque at 5,200 rpm, per Chevrolet Performance testing. The engine assembly comes with coil-near-plug ignition and an SFI-certified balancer. All that's needed to complete the assembly is a carburetor, starter and our LS/LSX ignition controller (P/N 19355863)—all available from Chevrolet Performance.

INSTALLATION NOTES

- Use LS/LSX ignition controller P/N 19355863 (not included). See page 113
- Requires addition of carburetor, starter, fuel system, exhaust system and front accessory drive system
- The 6-quart circle track oil pan is designed to clear most GM rear-steer chassis with stock engine location
- The engine is designed for circle track racing only. It is not intended for street use
- The CT525 does not include a water pump or factory exhaust manifolds
- Chevrolet Performance Circle Track racing engines include anti-tampering seals installed

 is the recommended engine oil for all Chevrolet Performance Engines

TECH SPECS

Part Number:	19434598
Engine Type:	LS-Series Gen IV Small-Block V-8
Displacement (cu in):	376 (6.2L)
Bore x Stroke (in):	4.065 x 3.62 (103.25 x 92mm)
Block (P/N 12729604):	Cast aluminum with 6-bolt, cross-bolted main caps
Crankshaft (P/N 12736809):	Nodular iron
Connecting Rods (P/N 12649190):	Powder metal with ARP bolts
Pistons (P/N 19418214):	Forged aluminum
Camshaft Type (P/N 88958770):	Hydraulic roller
Valve Lift (in):	.525 intake / .525 exhaust
Camshaft Duration (@.050 in):	226° intake / 236° exhaust
Cylinder Heads (P/N 12675871):	LS3 rectangular port; aluminum as-cast with 68cc chambers
Valve Size (in):	2.165 intake / 1.590 exhaust
Compression Ratio:	10.7:1
Rocker Arms (P/N 12696105 int):	Investment-cast, roller trunnion
Rocker Arms (P/N 12681275 exh):	Investment-cast, roller trunnion
Rocker Arm Ratio:	1.7:1
Recommended Fuel:	Premium pump
Maximum Recommended rpm:	6,700
Reluctor Wheel:	58x
Balanced:	Internal

 This Chevrolet Performance Racing Crate Engine is purpose-built for racing only, and has no warranty.

 Chevrolet Performance does not utilize any used or remanufactured parts in this crate engine, except for the starter, alternator and power steering pump.

 This part is intended for competition use only. See page 2 for complete details.

525 RLB

19435005 

533 hp*

@ 6,600 rpm

477 lb.-ft.*

@ 5,200 rpm

DYNO CHART

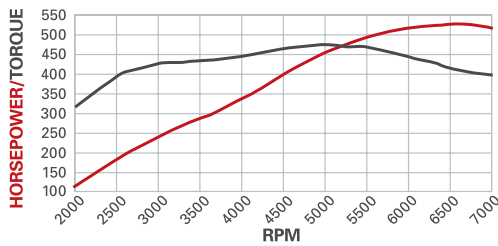

NOTE: Refer to page 6 for the complete horsepower and torque testing procedures.

*If equipped with 4 Barrel Carbureted Induction System.



The power and strength of our LS racing engine in a long block

Chevrolet Performance's 525 RLB is based on the LS engine family and is like the 6.2L CT525 but sold as a sealed long block for universal racing sanctioning bodies.

The high-revving 525 RLB crate engine is assembled with strong forged pistons and heavy-duty connecting rod bolts designed to support its performance capability and enhance its durability. With its deep-breathing LS3 rectangular-port cylinder heads, it is a combination rated at 533 horsepower at 6,600 rpm and a strong 477 lb.-ft. of torque at 5,200 rpm, when used with a 4-barrel carburetor and intake manifold, per Chevrolet Performance testing.

The engine assembly comes with coil-near-plug ignition and an SFI-certified balancer, along with a 6-quart racing oil pan and more. All that's needed to complete the assembly is an induction and ignition system — and all those components are also available from Chevrolet Performance.

INSTALLATION NOTES

- Requires addition of induction and ignition control system, starter, fuel system, exhaust system and front accessory drive system
- The 6-quart racing oil pan is designed to clear most GM rear-steer chassis with stock engine location
- The long block is designed for universal racing sanctioning bodies. It is not intended for street use
- The 525RLB does not include water pump, intake manifold or factory exhaust manifolds
- Chevrolet Performance Racing Long Block engines include factory-installed anti-tampering seals

Mobil 1 is the recommended engine oil for all Chevrolet Performance Engines

TECH SPECS

Part Number:	19435005
Engine Type:	LS-Series Gen IV Small-Block V-8
Displacement (cu in):	376 (6.2L)
Bore x Stroke (in):	4.065 x 3.62 (103.25 x 92mm)
Block (P/N 12729604):	Cast aluminum with 6-bolt, cross-bolted main caps
Crankshaft (P/N 12736809):	Nodular iron
Connecting Rods (P/N 12649190):	Powder metal with ARP bolts
Pistons (P/N 19418214):	Forged aluminum
Camshaft Type (P/N 88958770):	Hydraulic roller
Valve Lift (in):	.525 intake / .525 exhaust
Camshaft Duration (@.050 in):	226° intake / 236° exhaust
Cylinder Heads (P/N 12675871):	LS3 rectangular port; aluminum as-cast with 68cc chambers
Valve Size (in):	2.165 intake / 1.590 exhaust
Compression Ratio:	10.7:1
Rocker Arms (P/N 12696105 int):	Investment-cast, roller trunnion
Rocker Arms (P/N 12681275 exh):	Investment-cast, roller trunnion
Rocker Arm Ratio:	1.7:1
Recommended Fuel:	Premium pump
Maximum Recommended rpm:	6,700
Reluctor Wheel:	58x
Balanced:	Internal



This Chevrolet Performance Racing Crate Engine is purpose-built for racing only, and has no warranty.



Chevrolet Performance does not utilize any used or remanufactured parts in this crate engine, except for the starter, alternator and power steering pump.



This part is intended for competition use only. See page 2 for complete details.



Performance

Parts Offers News Culture +

Straight from the source

Turn your inbox into a winner's circle



Professional driver on a closed course.

Get the latest in high-performance news, product launches, build inspiration, offers, and more when you subscribe to monthly Chevrolet Performance emails. Scan the QR code or visit chevroletperformance.com to sign up.

Stay connected

@CHEVROLETPERFORMANCE



Stay tuned

THEBLOCK.COM



Performance
Vehicles / Parts / Racing

Small-Block Engine Components



Factory-Engineered Parts You Can Trust

Chevrolet engineers have refined Small-Block performance for more than 65 years, so you can rely on Chevrolet Performance parts when you build your engine.

More than supporting your horsepower dreams, Chevrolet Performance Small-Block engine components offer peace of mind. They're designed to the same rigorous standards as production engines, with the fit and durability that comes only from factory-designed and tested parts.

We've got it all: Tough four-bolt blocks, forged rotating parts and high-flow cylinder heads, along with all the supporting induction, fuel and spark components. Build the Small-Block your way, with power, strength and durability.

Trust the engineers who have been at it from the very beginning!

You can find these Chevrolet Performance Small-Block Engine Components on the following pages:

BLOCKS AND COMPONENTS	143	CRANKSHAFTS	156
CYLINDER HEADS	146	ACCESSORY DRIVE SYSTEMS.....	159
VALVE COMPONENTS	150	OIL PANS, OIL PUMPS, GASKETS AND COMPONENTS	159
VALVE COVERS.....	152	INTAKE MANIFOLDS.....	161
CAMSHAFTS	155	ELECTRICAL AND FUEL COMPONENTS.....	164
PISTONS AND PISTON RINGS	156		

Small-Block Blocks and Components

QUICK REFERENCE CHART

Cast-Iron Small-Blocks 🏆

Part Number	Cast #	Deck Height	Lifter Pattern	Cyl Wall	Bore Range	Main Bolt	Main Bolt Degree	Cap Material	Crank Jnl Size	Oiling	Seal Type	Max Stroke	Weight (lbs)	Max HP	Usage	Page Number
19431835	14093638	9.025"	Std	Open	4.000" – 4.030"	4	Straight	Gray iron	350	Wet	1 pc	3.750"	181	450	Street	143
19433406	—	9.025"	Std	Open	4.004" – 4.030"	4	Straight	Gray iron	350	Wet	1 pc	3.800"	181	450	Street	143
12480047 (Disc.)	10051184	9.025"	Std	Siamese	3.980" – 4.155"	4	20°	Nodular	350	Wet	2 pc	3.750"	208	550	Amateur	N/S
12480049 (Disc.)	10051184	9.025"	Std	Siamese	3.980" – 4.155"	4	20°	Nodular	400	Wet	2 pc	3.750"	208	550	Amateur	N/S
24502503 (Disc.)	10051184	9.025"	Std	Siamese	3.980" – 4.155"	4	20°	Steel	350	Wet	2 pc	3.750"	208	700	Pro	N/S

Aluminum Small-Blocks 🏆

Part Number	Cast #	Deck Height	Lifter Pattern	Cyl Wall	Bore Range	Main Bolt	Main Bolt Degree	Cap Material	Crank Jnl Size	Oiling	Seal Type	Max Stroke	Weight (lbs)	Max HP	Usage	Page Number
10134400	10134398	9.025"	Std	Siamese	4.117" – 4.135"	4	20°	Steel	400	Dry	2 pc	3.750"	89	800	Pro	144

Deck Height Diagram

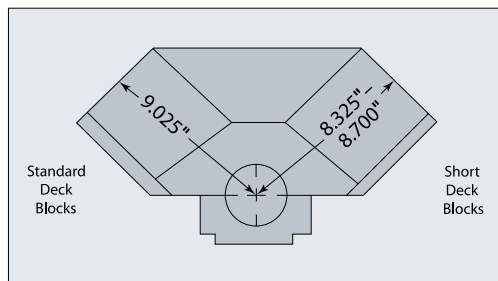

Production-Based Block (top, front)

PRODUCTION-BASED BLOCKS

When building a mild Small-Block performance engine, production-based blocks from Chevrolet Performance offer strength, accuracy and peace of mind that can't be assured in a rebuilt core. And, unlike so many of the used cores, nearly all of ours feature four-bolt main caps for extra strength. Each cylinder block is machined to production-spec tolerances and is manufactured to the exact specifications of pre-1986 or 1986-and-later engines.

Production-Based Block Technical Notes:

- Standard 350 main journal sizes
- Lifter valleys machined for hydraulic-roller and flat-tappet valvetrains
- Production-spec cylinder wall thickness
- Non-siamese bores

See the chart above for complete specifications



Production-Based Block (top, rear)



Straight 4-Bolt Mains



Production-Based Block (top, front)

Part Number	Description	Technical Notes
19431835 🏆	350 Bare Block – 1986–Later Style, 1-Piece Rear Main Seal	Cast-iron 4-bolt block; 4.000" bore; Machined for hydraulic roller or flat tappets
19433406 🏆	383 Bare Block – 1986–Later Style, 1-Piece Rear Main Seal	Cast-iron 4-bolt block; 4.005" bore; Torque plate honed; Cleared for 3.800" stroker crankshaft; Machined for hydraulic roller or flat tappets



Parts intended for competition use only. See page 2 for details.



Performance

ALUMINUM RACE BLOCKS

Less weight and the same great horsepower are the benefits of a Chevrolet Performance Aluminum Race Block. Chevrolet Performance Aluminum Race Blocks provide the same competition-level strength and reliability of our cast-iron race blocks, but their lighter weight improves chassis dynamics. The super-tough A-356 aluminum competition blocks are CNC-machined to +/- .005-inch tolerances. Chevrolet Performance Aluminum Race Blocks are for competition applications, including high horsepower turbocharged engines.*

See the chart on page 143 for complete specifications.

*Proposed applications have not been specifically tested or validated by Chevrolet Performance.

Chevrolet Performance Aluminum Race Block

Technical Notes:

- Extra-thick deck surface with blind-tapped head bolt holes for improved head gasket sealing
- Centrifugally spun cast-iron cylinder sleeves
- 2-piece rear-main crankshafts and pre-1986 oil pans required
- Enlarged cam bosses allow machining for larger cam bearings
- 2.000" O.D. (1.867" I.D.) cam bearings
- Blocks may require clearancing at top of lifter bores (.842") for some roller lifters
- Timing system clearance should be checked before engine assembly
- Extra-thick main bearing bulkhead machined at 5°
- Premium main studs and steel main bearing caps
- Priority main oiling system
- Billet wet sump rear main cap can be converted to dry sump with plugs
- Oil dipstick holes not drilled
- Comes with dowel pins

10134400 

400 Aluminum Bare Block

- A-356 aluminum competition block
- CNC-machined
- Siamesed bores with increased wall thickness
- 4.117" rough-finished bore
- 4.135" maximum bore
- 3.750" maximum stroke
- Splayed 4-bolt steel mains
- 400 main size
- Dry sump use only
- Tested to more than 800 horsepower!



400 Aluminum Race Block (top, front)



400 Aluminum Race Block (bottom, rear)



400 Aluminum Race Block (top, rear)

CYLINDER BLOCK COMPONENTS



Universal Engine Lift Brackets



Core Plug - 1-5/8" brass



Cylinder Sleeve - Standard



Main Bearing Kit - 350 Engine, Standard



Main Bearing Bolt Kit - Sportsman Blocks

Part Number	Description	Technical Notes
12363238	Universal Engine Lift Brackets	Designed to bolt to the end of cylinder heads for removal and installation of the engine; Made from .200" steel and have .880" x 1.000" hook slots. Use with 3/8" or 7/8" bolts; Includes two brackets and two 3/8" bolts
94673017	Core Plug - 1-5/8" Brass	Corrosion-resistant brass core plug is recommended for marine applications
10121044	Rear Oil Seal - 2-Piece Design (not shown)	Rear oil seal for V-8 and V-6 engines with pre-1985 style 2-piece oil seal design, used by many NASCAR teams for superior leak protection
12480004	Cylinder Sleeve - Standard	Standard-bore steel cylinder sleeve for late-design aluminum Small-Block V-8 and 90° V-6 aluminum blocks, including P/N 10134400 NOTE: Sleeve has 3.980" bore; can be overbored to 4.135"
12499102	Main Bearing Kit - 350 Engine, Standard	Complete main bearing kit for 350-cubic-inch Small-Block V-8 with standard-size mains
12480108	Main Bearing Bolt Kit - Sportsman Blocks	Sturdy main bearing cap bolts designed specifically for the following Chevrolet Performance Sportsman Racing Blocks: P/N 12480047, P/N 12480049, P/N 12480157, P/N 12480159, P/N 12480174 and P/N 12480175; Bolts are Grade-8 with 12-point heads and black oxide coating

FRONT COVERS, TIMING POINTERS AND FUEL PUMP BLOCK-OFF PLATES



Timing Pointer - 6.75" & 7" Balancer





Small-Block Chrome Timing Cover



Front Cover with Bolts, Seal and Gasket



Small-Block Fuel Pump Block-Off Plate

Part Number	Description	Technical Notes
3991435	Timing Pointer - 6.750" and 7" Balancer	Steel timing pointer bolts onto engines with 6.750" or 7" balancers; Pointer is not chrome
12342089	 Small-Block Chrome Timing Cover	Attractive chrome cover for 1969-1991 Small-Block V-8 and all 90° V-6 engines; Direct replacement for covers that use bolt-on timing pointer; Supplied with GM oil seal (replacement oil seal P/N 10243247)
12562818	 Front Cover	With crank trigger plug; Includes bolts, seal and gasket
12341998	Small-Block Fuel Pump Block-Off Plate	Plate has stamped Bowtie logo; Gasket included

 Timing Covers: Additional Required Components

Part Number	Bolts (Quantity)	Seals (Quantity)	Gasket (Quantity)	Bolt Grommets (Quantity)	Engine Application
12342089	11561767 (10)	14090906 (1)	10108435 (1)	N/A	19435602, 19433030, 19433038
12562818	10213293 (6)	10228655 (1)	N/A	10213294 (8)	19433036, 19435620, 19435604



Parts intended for competition use only. See page 2 for details.



Additional components required for installation. See chart above



Small-Block Cylinder Heads

QUICK REFERENCE CHART

Part Number	Description	Casting Number	Material	Port Vol (cc)	Valve Angle	Chbr (cc)	Int Vlv (in)	Exh Vlv (in)	Int Port Type	Exh Port Tiype	Plug Type	Heat Riser	Rocker Mount	Notes	Page
19417591	Fast Burn ZZ6	19417568	Alum	210	23	62	2.000	1.550	Vortec	LT4	Angled	No	Screw-in	Bare	N/S
19417592	Fast Burn ZZ6	19417568	Alum	210	23	62	2.000	1.550	Vortec	LT4	Angled	No	Screw-in	Assembly	147
12691728	Vortec	10239906 or 12558062	Iron	170	23	62	1.940	1.500	Vortec	LT4	Straight	No	Press	Assembly	146
19331471	Small-Port Vortec Bowtie	25534351	Iron	185	23	66	2.000	1.550	Vortec	LT4	Straight	No	Screw-in	Bare	N/S
19331473	Large-Port (Discon.)	25534371	Iron	225	23	66	2.000	1.550	Vortec	LT4	Straight	No	Screw-in	Bare	N/S
19331470	Small-Port Vortec Bowtie	25534351	Iron	185	23	66	2.000	1.550	Vortec	LT4	Straight	No	Screw-in	Assembly	147
19331472	Large-Port (Discon.)	25534371	Iron	225	23	66	2.000	1.550	Vortec	LT4	Straight	No	Screw-in	Assembly	147
12480129	SB2.2	12480011	Alum	–	SB2.2	48	2.150	1.625	SB2.2	SB2.2	Angled	No	Shaft	No seats/guides	148
12480011	SB2.2 Bare	12480011	Alum	–	SB2.2	48	2.150	1.625	SB2.2	SB2.2	Angled	No	Shaft	No seats/guides	148
88958667	ROX SB2.2	88958667	Alum	–	SB2.2	28	2.150	1.625	SB2.2	SB2.2	–	–	Shaft	No seats/guides	N/S
12480146	Rough Bare Splay (Discon.)	24502517	Alum	–	Splay	45	2.200	1.650	Splayed	Splayed	Angled	No	Shaft	Rough mach 24502517	N/S
12480147	Semi-Machined Splay (Discon.)	10185040	Alum	–	Splay	45	2.200	1.650	Splayed	Splayed	Angled	No	Shaft	Semi-mach 12480146	148
24502517	Splayed Valve (Discon.)	10185040	Alum	–	Splay	45	2.200	1.650	Splayed	Splayed	Angled	No	Shaft	No seats/guides	N/S
12480153	ROX Splayed (Discon.)	12480153	Alum	–	Splay	–	–	–	Splayed	Splayed	–	–	Shaft	No seats/guides	N/S

VORTEC CYLINDER HEADS

An easy way to gain 20–40 horsepower on any 1955-and-newer Small-Block Chevrolet V-8 (except later-style LT1/LT4 engines with reverse-flow cooling) is by installing a set of Vortec cylinder heads. These value-priced cast-iron cylinder heads use modified combustion chambers and high-velocity port technology to provide improved airflow performance compared to Gen I-style designs. Vortec cylinder heads significantly outflow non-Vortec service replacement cylinder heads and earlier OEM cast-iron heads. These cylinder heads are ideal for applications up to 350 horsepower, but they require Vortec-specific intake manifolds and center bolt valve covers.

12691728

Cast-iron Vortec Cylinder Head Assembly

- Completely assembled with 1.940"/1.500" valves
- Uses bare head 12691727
- 62cc combustion chamber
- Straight spark plugs
- No heat risers
- Requires Vortec-specific intake manifold
- Camshafts with more than .475" lift require machining valve guide bosses and checking valve seal to valve spring retainer clearance
- Can be machined for 2.020"/1.600" valves
- Rocker arm studs can be pinned or drilled and tapped to 3/8"
- Valve spring seat diameter is 1.280"
- Casting number 10239906 or 12558062



Cast-Iron Vortec Cylinder Head (exhaust)



Cast-Iron Vortec Cylinder Head (combustion chamber)



Cast-Iron Vortec Cylinder Head (intake)



VORTEC BOWTIE CYLINDER HEADS

Vortec Bowtie Cylinder Heads are the most powerful cast-iron heads offered by Chevrolet Performance. These upgraded production cylinder heads are ideal for 400–450 horsepower racing engines (great for circle track applications). Vortec Bowtie Cylinder Heads come with bigger valves, a thicker deck surface and 62cc combustion chambers. The heads provide outstanding low-lift flow numbers (the more air you flow, the more potential power) and Fast Burn performance in an affordable, cast-iron head.

Vortec Bowtie Cylinder Head Technical Notes:

- Cast-iron small runner or large runner cylinder heads*
- 62cc combustion chambers
- .450" deck thickness
- Hardened exhaust valve seats
- Machined for 2.000"/1.550" valves
- Maximum .530" valve lift (without modifications)
- Straight spark plug design
- No heat risers
- Drilled and tapped for 7/16"-14 screw-in studs
- Dual bolt patterns for Vortec and early-style intake manifolds (Vortec intakes P/N 12366573, 12496820, 12496821, 12496822 or 12489371)
- Use intake gasket P/N 89017465 for Vortec intakes or dual pattern intake gasket P/N 19301685 for early-model intakes or Vortec design intake manifolds
- Dual bolt patterns for perimeter-style and center-bolt valve covers
- Vortec intake manifold three-step torque specs: 2 lb.-ft.; 9 lb.-ft.; 11 lb.-ft.

*Larger intake and exhaust ports allow for a greater volume of air to pass through the engine. The more air you flow, the more power you can make. Large-port cylinder head is discontinued.

Part Number	Description	Technical Notes
19331470 	Small-Port Vortec Bowtie Cylinder Head Assembly	Completely assembled, ready to bolt on; 185cc intake ports; 65cc exhaust ports; Use Fel-Pro® P/N 1470 exhaust gasket; Bare head P/N 19331471, available separately
19331472  	Large-Port Vortec Bowtie Head Assembly (not shown)	Completely assembled, ready to bolt on; Improved air flow (281 cfm @ .600"); 225cc intake ports; 77cc exhaust ports; 65cc combustion chambers; Use Fel-Pro® P/N 1470 exhaust gasket (minor trimming may be necessary); Bare head P/N 19331473, available separately



Small-Port Vortec Bowtie Cylinder Head (intake)

ALUMINUM FAST BURN HEADS

Chevrolet Performance's Fast Burn 23-degree cylinder heads deliver maximum performance for Small-Block engines. An aluminum head casting—distinguished by Chevy Bowtie logos at each end—and a valvetrain with high-rpm, LS-style beehive-type valve springs stretches the performance range of the heads to enable greater power at a higher rpm. Fast Burn technology delivers more horsepower by increasing cylinder pressures, which maximizes the air/fuel mixture's combustion. The 62cc combustion chamber is designed for use with flat-top pistons. The CNC-machined Fast Burn heads require no additional porting for optimal performance, so all you need to do is bolt them onto your Small-Block and go! They can be used on any Small-Block engine with at least 4.000-inch bores and the standard-flow coolant system. Not for use on Gen II 1992–1996 LT1/LT4 engines with reverse-flow cooling system.

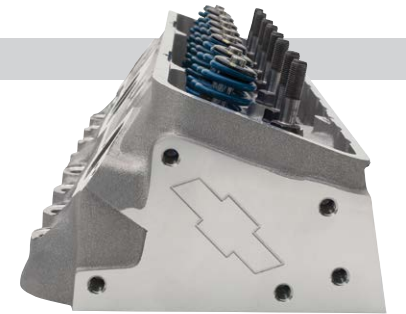

Fast Burn Cylinder Head



Fast Burn Cylinder Head (intake)



Fast Burn Cylinder Head (exhaust)



Fast Burn Cylinder Head (combustion chamber)

19417592

Fast Burn Aluminum Cylinder Head Assembly

- CNC-machined aluminum performance cylinder head
- Completely assembled with 2.000"/1.550" valves
- 210cc intake port, roof raised .240"
- 78cc D-shaped exhaust ports, raised .200" — requires Fel-Pro® exhaust gasket P/N 1470 (may require minor trimming)
- 62cc combustion chamber, .400" deck (can be milled up to .060")
- No heat riser
- Angled spark plugs (5/8" hex, 3/4" reach, tapered plugs)
- 1.48" valve spring seat diameter
- Use head gaskets with stainless steel fire rings
- Raised, machined rocker rails
- .530" maximum valve lift (without modifications)
- Screw-in studs (3/8" top, 7/16" bottom)
- New "time-serts" prevents oil migration through rocker studs
- Dual bolt patterns for perimeter-bolt and center-bolt valve covers
- Dual bolt patterns for Vortec and early-model intake manifolds
- Machined bare head P/N 19417591
- Use intake gasket P/N 19301685



Parts intended for competition use only. See page 2 for details.



Additional components required for installation. See chart on page 149.



Performance

147

SPLAYED-VALVE ALUMINUM RACE CYLINDER HEADS

Chevrolet Performance Splayed-Valve Aluminum Race Cylinder Heads are extremely aggressive, all-out competition heads. Splayed valves point both intake and exhaust valves at the center of the cylinder bore. As the valves open, they move away from the edges of the bore. That allows maximum-size valves to be installed without increasing bore size. The result is dramatically increased airflow, compared to inline-valve-design cylinder heads.

The castings have a .240-inch minimum port wall thickness, which leaves ample room for extensive custom porting. Intake valves are angled 16 degrees to the deck surface and splayed 4 degrees. Exhaust valve angles are 11 degrees with a 4-degree splay. Making more than 1,000 naturally aspirated horsepower with these cylinder heads is easily achievable.

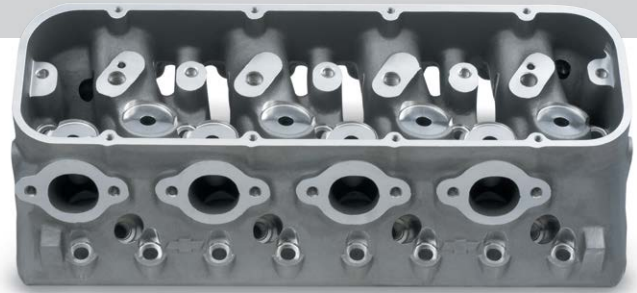

Splayed-Valve Center Cylinder Head (exhaust)

Aluminum Splayed-Valve Race Head Technical Notes:

- Made of 355-T7 aluminum
- No valve seats or guides provided
- Extra-thick decks for angle milling or heavy flat milling
- Extra port material (.240") for professional porting
- Completely revised intake and exhaust ports provide ultimate airflow potential
- 45cc "as-cast" combustion chambers
- Modified valve angles (16° x 4° intake and 11° x 4° exhaust)
- Designed for longer-than-stock 2.200" and 1.650" valves
- Valve spring pads accommodate 1.625" diameter springs
- Revised location angled spark plugs (14mm, 5/8" hex, 3/4" reach, gasketed plugs)
- Designed for aftermarket shaft-mount rocker systems
- Custom-fabricated intake manifold required
- Valve cover gaskets required (P/N 10185043)

Part Number	Description	Technical Notes
12480147	Semi-Machined Splayed-Valve Aluminum Cylinder Head (Discontinued)	Main surfaces are machined; exhaust bolt pattern, valve guides and spark plug holes are machined; Head bolt holes, dowel holes, intake bolt holes and pushrod holes are not machined; Valve seats, spring seats and rocker stands are not machined; 240cc "as-cast" intake ports; 78cc "as-cast" exhaust ports; 45cc "as-cast" combustion chambers; Same casting as P/N 12480146

SB2.2 NASCAR RACE CYLINDER HEADS

The Chevrolet Performance SB2.2 NASCAR Racing Head was designed to help durability, simplify preparation procedures, and reduce the overall cost of building and maintaining a Small-Block Chevrolet racing engine. It is ideal for single, four-barrel carburetor applications due to having "mirror" design intake ports and all eight ports being angled toward the center of the engine. Spark plug holes were moved toward the bore center for combustion efficiency. 48cc combustion chambers permit 12.1:1-compression-ratio flat-top pistons.



SB2.2 Cylinder Head (exhaust)

Aluminum SB2.2 NASCAR Race Head Technical Notes:

- 355-T7 X-rayed and "hipped" aluminum competition cylinder heads
- Extra-thick decks for heavy flat milling
- Extra material around ports for professional porting
- Combustion chambers are very small, shallow and wedge-shaped
- Precision T-washers installed in all four center head bolt bosses
- Designed for longer-than-stock 2.150" and 1.625" valves
- Valve spring pads accommodate 1.625" diameter springs
- Modified valve angles: 11° x 4° intake and 8° x 0° exhaust
- Designed for aftermarket shaft-mount rocker systems
- Revised location angled spark plugs (14mm, 5/8" hex, 3/4" reach, gasketed plugs)
- Requires specific left- and right-hand pistons
- Valve cover P/N 12480006
- Replacement AN-08 intake port plugs available as P/N 12480171

Part Number	Description	Technical Notes
12480011	Semi-Finished SB2.2 Aluminum Cylinder Head (Discontinued)	Aluminum NASCAR-accepted head; Bare head, no seats or guides installed; Standard .500" guide holes; "As-cast peanut" ports; 48cc "as-cast" combustion chamber
12480129	Semi-Finished SB2.2 Aluminum Cylinder Head (Discontinued)	Aluminum NASCAR-accepted head; Bare head, no seats or guides; Reduced size .375" diameter guide holes; "As-cast peanut" ports; 48cc "as-cast" combustion chamber

*HIP is the acronym for hot isostatic pressure. This process puts the heads in a sealed vessel where a vacuum is first used to remove room air and any possible contaminants. The vessel is filled with high pressure nitrogen (up to 30,000-psi) and then heated to the required temperature and sustained for a determined amount of time. The cooling process is also a controlled procedure to ensure maximum strength and proper heat treat. This extreme high pressure and heat removes almost 100% of the internal porosities that are generated during the casting process. The material integrity, strength and fatigue life increases significantly.

CYLINDER HEAD GASKETS, HEAD BOLTS AND STUDS

Chevrolet Performance cylinder head gaskets, cylinder head bolts and cylinder head studs are made with high-quality materials. Their superior construction helps ensure optimum sealing between cylinder heads and the engine block.

Gasket packages contain one gasket unless otherwise specified. Head gaskets are available in a variety of materials and thicknesses. Use the proper gasket to maintain compression ratios and minimum piston-to-cylinder-head clearance-

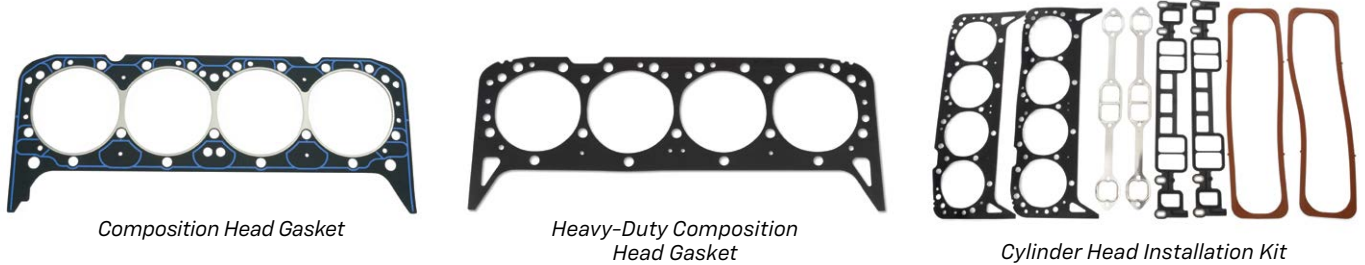

Part Number	Description	Technical Notes
10105117	Composition Head Gasket	Composition head gasket with stainless steel fire ring; For stock or mildly modified engines with 4.0" cylinder bores; Fits cast-iron or aluminum heads; Used on Ram Jet 350; .028" compressed thickness
3830711	Steel Shim Head Gasket	For stock and mildly modified engines with 4.0" cylinder bores; .026" compressed thickness
12732510	Steel Shim Head Gasket	Stainless steel fire rings; Fits aluminum or cast-iron heads; Used on ZZ6 and 350 HO engines; .051" compressed thickness
10185054	Heavy-Duty Composition Head Gasket	Teflon-coated; Pre-flattened wire O-rings around each cylinder; For competition engines with cylinder bores of 4.0" to 4.125"; .041" compressed thickness NOTE: Drill steam holes when used on 400-ci Small-Blocks. Gasket does not require re-torquing.
12499223	Cylinder Head Installation Kit - 5.7L L31 Engine	Comprehensive kit; Includes 2 cylinder head gaskets, 2 valve cover gaskets, 2 intake manifold gasket sets and 2 exhaust manifold gaskets; .028" compressed thickness
14011040	Hardened Washer	.450" I.D. x .778" O.D. ; Sold individually
10051155	Hardened Washer	.450" I.D. x .750" O.D.; Sold individually, for Phase 6 and raised-runner aluminum heads
585927	Cylinder Head Dowel Pin	Dowel pin 5/16" diameter by 3/8" long; For all Small-Block V-8 and 90° V-6 engines
12495499	Cylinder Head Bolt Kit	For iron or aluminum heads, Includes 14 of P/N 10168525; 4 of P/N 10168526, 16 of P/N 10168527, and thread sealant

OVERHAUL GASKET KITS

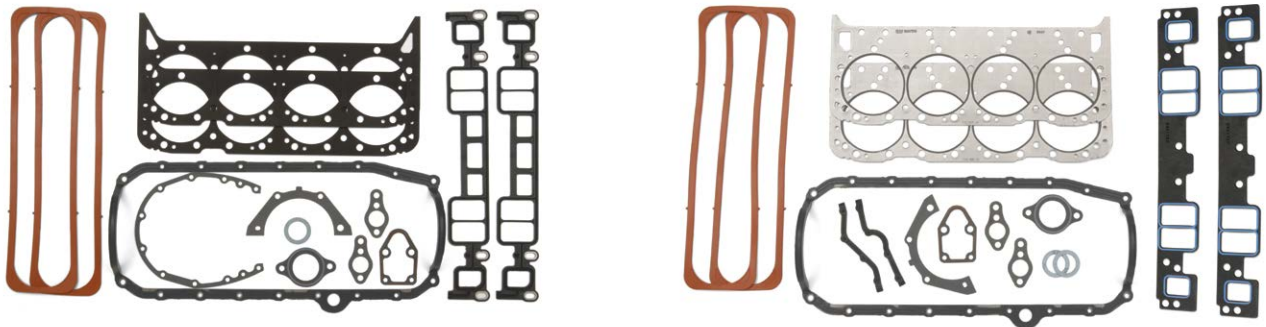

**19201171
Rebuild Gasket Kit**

- Fits 350 HO, HT383 and CT350 Circle Track engine
- Includes head gaskets, oil pan gasket set, rear main seal housing gasket, intake manifold gasket set, water outlet gasket, front cover gasket, fuel pump adapter gasket, water pump gaskets, distributor gasket, valve cover gaskets, crankshaft rear main seal

**19201172
Rebuild Gasket Kit**

- Fits SP350/385, ZZ6, SP383 and CT400 Circle Track engine
- Includes head gaskets, oil pan gasket set, rear main seal housing gasket, intake manifold gasket set, water outlet gasket, fuel pump adapter gasket, water pump gaskets, distributor gasket, valve cover gaskets, crankshaft rear main seal

Small-Block Cylinder Heads Additional Required Components				
Part Number	Head Gaskets (Quantity)	Bolts (Quantity)	Spark Plug	Engine Application
12691728	10105117 (2) OR 12557236 (2)	10168525 (14), 10168526 (4), 10168527 (16)	19354420	19435602, 19433031, 19433036, 19433030, 19433038
19417592	10105117 (2) OR 12557236 (2)	10168525 (14), 10168526 (4), 10168527 (16)	19355201	19435604
19331472	10105117 (2), 10185054 (2)	10168525 (14), 10168526 (4), 10168527 (16)	N/A	



Parts intended for competition use only. See page 2 for details.



Additional components required for installation. See chart above.



VALVES



Intake Valves

Part Number	Valve Size	Stem Size	Description
10241743	1.940"	1/32"	Stock replacement valve used in all crate engines except CT350/400, SP350/385 and SP383/435
12555331	2.000"	1/32"	Stock replacement valve used in the 1996 LT4 engine and in our CT400, P350/385 and SP383/435; also in Fast Burn heads
12363757	2.000"	1/32"	Stainless steel valves with undercut stems to improve air flow, single groove design, chrome-plated stems to reduce wear, hardened tips to withstand high loads

Exhaust Valves

Part Number	Valve Size	Stem Size	Description
12550909	1.500"	1/32"	Stock replacement valve used in all of our crate engines except CT350/400, Fast Burn 385 and ZZ383/425
12551313	1.550"	1/32"	Stock replacement valve used in the 1996 LT4 engine, and in our CT400, Fast Burn 385 and ZZ383/425; Also in LT4 and Fast Burn heads

VALVE SPRINGS



Part Number	Spring Type	Outside Diameter	Pressure at Installed Height	Solid Height	Average Weight (lbs @ in)	Retainer Part Number	Valve Seal Kit	Technical Notes
94666580	Single w/ damper	1.241"	80# @ 1.700"	1.150"	267	—	12511890	Production spring for 350/290 HP engines
330585	Dual	1.379"	140# @ 1.750"	1.150"	325	—	12511890	Use with all moderate lift racing cams
10206040	Single spring	1.300"	85# @ 1.780"	1.260"	373	—	N/A	1992–1993 LT1 production Corvette engine
12713265	Single spring	1.320"	101# @ 1.780"	1.220"	332	19301708	N/A	CT400, ZZ6, SP383 (Beehive Spring)
19420455	Spring kit	1.320"	101# @ 1.780"	1.220"	332	19301708	N/A	Kit of 16 springs P/N 12625033 (Beehive Spring)
10212811	Single spring	1.250"	80# @ 1.700"	1.200"	256	10241744	N/A	CT350/350, 350HO engines
19154761	Spring kit	1.250"	80# @ 1.700"	1.200"	256	10241744	N/A	Kit of 16 springs P/N 10212811 (see above)

Valve Spring Components

Part Number	Description	Technical Notes
10212809	LT4 Valve Spring Shim	Lightweight shims as used on 1996 LT4 Corvette special LT service heads and Fast Burn heads. Use with spring P/N 12551483
3875916	Spring Shim	55/64" I.D. x 1-31/64" O.D. x .015" thick
10212810	Valve Stem Seal	Used on LT4 and ZZ4 heads as well as Chevrolet Performance Parts head assemblies P/N 19331470, 19331472, and 19300995
12511890	Valve Stem Seal Kit	Late-model V-8 seal kit for 1/32" diameter valve stems. Includes 8 intake seals, 8 exhaust seals and 16 oil stem seals NOTE: Check for seal-to-guide interference with high-lift cams.
10241744	Valve Spring Retainer	Used on 350 HO, 350 Ram Jet and HT383
10045007	Valve Spring Retainer	For all ZZ3 series engines; NOTE: When converting ZZ1 or ZZ2 engines to ZZ3 series cap, valve spring shield must be removed and add cap P/N 10045007, seal P/N 10212810.
19171528	LT4 Valve Spring Cap Kit	Kit for 5.7L LT4 engines. Includes 16 P/N 19169661 lightweight retainers. Use with spring kit P/N 12495494 and key kit P/N 12495503. Used on ZZ4, Fast Burn LT4 and iron Vortec Bowtie heads
19169661	Heavy Duty Vortec Valve Spring Retainer	Fits Fast Burn and Vortec Bowtie cylinder heads. Designed for circle track racing
12495503	Valve Spring Key Kit	Kit includes 32 keys of P/N 24503856 for 11/32" valve stems. Use on all Small-Block V-8 engines

19421192 🚧

Beehive Spring Conversion Kit

To gain greater high-rpm capability and valvetrain stability, convert the valvetrain on your aluminum Fast Burn heads to the beehive-type system used on Chevrolet Performance's latest Fast Burn heads (P/N 19417592) on the SP350, ZZ5, ZZ6, SP383 and ZZ383 crate engines, and on the CT400. The springs, retainers and other hardware are direct replacements for the conventional springs and hardware, with no machining of the valve spring seat required. The engine's existing intake and exhaust valves are retained, allowing installation without cylinder head removal if compressed air or another method is used to hold the valves closed. The engine's existing rocker arms are also retained.

The kit comes with components to convert a pair of cylinder heads, including:

Part Number	Description	Quantity
12713265	Spring	16

NOTE: The conversion kit is intended only for Fast Burn heads and is not compatible with Vortec heads because of insufficient room for the spring seats.



Service Kit Includes:

Part Number	Description	Quantity
19420455	Spring Kit	1
19303149	Cap	8
19303150	Seat	8
19302868	Keeper	16

NOTE: Must use with P/N 19432298 or P/N 19210729 Rocker Arms for adequate clearance.

ROCKER ARMS

Aluminum Roller Rocker Arm – 3/8" Studs

These Chevrolet Performance Aluminum Roller Rocker Arms resemble the ones used in the 1996 Corvette LT4 engine, except the trunnions have been machined to fit early-model 3/8" rocker studs. The arms are self-aligning with improved stiffness, compared to stamped steel production rocker arms. They will accommodate up to .575" valve lift. They are available in 1.5:1 and 1.6:1 ratios.



Roller Rocker Arm Set – 1.5:1 Ratio



Roller Rocker Arm (top) with adjuster nut



Roller Rocker Arm (bottom)



Adjuster Nut for Roller Rocker Arm



"Kool Nut"

Part Number	Description	Technical Notes
19432298	Roller Rocker Arm Set – 1.5:1 Ratio	Set of 16, 3/8" stud 1.5:1 ratio roller rockers; Use P/N 19432297 for single service part
19210729	Roller Rocker Arm Set – 1.6:1 Ratio (not shown)	Set of 16, 3/8" stud 1.6:1 ratio roller rockers; Use P/N 19210725 for single service part NOTE: When using a high-lift camshaft, check valve spring coil bind, retainer-to-seal clearance and piston-to-valve clearance. Check for adequate pushrod clearance when using on cast-iron heads. It may be necessary to remove valve cover drippers for proper rocker arm clearance. Cannot be used on ZZ3 engines with orange valve springs.
19210725	Adjuster Nut for Roller Rocker Arm	3/8" adjustment nut; Used on both aluminum rocker arm kits P/N 19432298 and P/N 19210729
19210731	"Kool Nut" (single)	Special rocker arm nuts are used on GM Circle Track engine P/N 19435602; Can be used with any stamped steel rocker arm

12495490

Rocker Arm Kit, Steel – 1.5 Ratio (set of 16)

These self-aligning, high-quality rockers have a nominal 1.5:1 ratio. The kit includes 16 stamped steel rockers with pivot balls and nuts. Use P/N 10089648 for single service part. For use with 3/8" studs.

NOTE: Not recommended for mechanical lifter camshafts.



Parts intended for competition use only. See page 2 for details.



Performance

VALVE COVERS

People can't see the beautiful porting artistry inside your Chevrolet Performance aluminum cylinder heads, but they can and do see the valve covers. To make sure your GM engine looks as great as it runs, Chevrolet Performance offers a wide selection of precision-engineered, branded valve covers. The valve covers are either aluminum or stamped steel. They're designed to seal tightly and help minimize the chance of oil leakage. Taller competition valve covers are made to easily clear high-performance valvetrain components.

NOTE: Valve covers are sold in pairs unless otherwise specified. Valve covers cannot be used with 15° or 18° heads unless otherwise stated.

10185064**Tall Aluminum Valve Covers**

- Competition racing valve cover displays the Chevrolet name and Bowtie logo
- Natural cast finish
- No holes for PCV or oil fill, but has bosses for drilling them
- Designed for pre-1986 engines with perimeter hold-downs
- Can be used with 15° and 18° heads
- Use P/N 10185052 for single service part

**12497985****Chrome-Finish Aluminum Valve Covers – Center Bolt Design**

- Die-cast with chrome finish
- Approximately ¼" taller than production covers
- For use on 1986-and-newer engines with center hold-downs
- Kit includes bolts, washers and seals



NOTE: Use valve cover gasket P/N 10046089 and replacement bolt and seal kit P/N 12497980.

12480127**Short Aluminum Valve Covers**

- Cast-aluminum Chevy Bowtie-design valve cover is similar to P/N 10185064 except it is a short style with a PVC hole in both covers (grommets included)
- Natural cast finish
- Designed for pre-1986 engines with perimeter hold-downs
- Covers have oil baffle
- Not to be used with the 350/290 crate engine



NOTE: For use with 1.5 ratio stamped rocker arms only.

12497979**Aluminum Black Crinkle Valve Covers – Center Bolt Design**

- Die-cast with black crinkle finish
- Approximately ¼" taller than production covers
- For use on 1986-and-newer engines with center hold-downs
- Kit includes bolts, washers and seals
- Factory-installed on new SP383 crate engines



NOTE: Use valve cover gasket P/N 10046089 and replacement bolt and seal kit P/N 12497980.

24502466**Tall Valve Covers – No Logo**

- Create your own custom valve covers!
- Cast-aluminum valve cover is similar to P/N 10185064, but has no logo
- Cast with extra material to permit milling a custom logo



NOTE: Sold as single piece. Order 2 per engine.

3726086**Original Corvette V-8 Valve Covers**

- 1956–1959 V-8
- Offset bolt holes will not fit newer V-8 heads



NOTE: Sold as single piece. Order 2 per engine.

12341670**Chrome Short Valve Covers**

- Short chrome valve covers with baffle
- For use on pre-1986 engines with perimeter hold-downs
- Chevrolet and the Bowtie logo are embossed on top



NOTE: For use with 1.5 ratio stamped rocker arms only.

19351534**Black Slant-Edge Valve Covers**

- Includes bolt kit P/N 19351801 and grommet kit P/N 12341988
- Factory-installed on ZZ6 crate engines
- Die-cast with black crinkle finish
- For use on 1986-and-newer engines with center hold-downs
- Fits Fast Burn aluminum and Bowtie cast-iron heads with center hold-downs

**12497978****Polished Aluminum Valve Covers – Center Bolt Design**

- Die-cast aluminum valve covers
- Polished to a bright shine
- Approximately ¼" taller than production covers
- For use on 1986-and-newer engines with center hold-downs
- Kit includes bolts, washers and seals
- Installed on ZZ5 and SP350 crate engines



NOTE: Use valve cover gasket P/N 10046089 and replacement bolt and seal kit P/N 12497980.

19351803**Natural Gray Slant-Edge Valve Covers**

- Includes bolt kit P/N 19351801 and grommet kit P/N 12341988
- Die-cast with natural finish
- For use on 1986-and-newer engines with center hold-downs
- Fits Fast Burn aluminum and Bowtie cast-iron heads with center hold-downs



25534359 
Circle Track Valve Covers, Center Bolt Design

- Sheet metal valve cover kit designed for Gen I design circle track engines equipped with center hold-down cylinder heads
- Equipped with 2 breather pipes on 1 cover and no pipes on the other



NOTE: Use breather kit P/N 25534355 (2 come in kit).

25534420
Pontiac 301-455 V-8 Valve Covers

- Stylish covers fit 301-455 cubic-inch Pontiac engines manufactured 1965-1979
- Designed for stock valvetrains and may not clear aftermarket rocker arms, springs or stud girdles
- Each cover has one 1.220" hole on left side for oil fill cap; or grommet for PCV or fresh air inlet
- Covers have a natural aluminum finish with machined Pontiac name and logo
- Includes 2 covers and grommet kit P/N 12341988



NOTE: Does not fit Small-Block Chevy heads.

ADAPTERS, HARDWARE AND BREATHERS

12497980
Chrome Bolt Kit - Center Bolt Design

- Service replacement parts for 1986-and-newer center hold-down design, die-cast aluminum valve covers in chrome, crinkle and polished finishes
- Will not fit production valve covers



19420495
Chrome Hold-Down Bolt (not shown)

- Chrome valve cover hold-down bolt
- Used on all 1986-and-newer engines with center hold-down design stamped valve covers

NOTE: Package contains 1 bolt. Order 4 per valve cover.

10066008
Black Hold-Down Bolt (not shown)

- Black valve cover hold-down bolt
- Used on all 1986-and-newer engines with center hold-down design stamped valve covers

NOTE: Package contains 1 bolt. Order 4 per valve cover.

88962074
Oil Baffle Tube

- Pushes easily into most valve covers that have an oil baffle
- Requires breather P/N 25534355; used on ZZ572 engines



25534355
Circle Track Breather

- Special breathers are for circle track valve covers used on circle track and ZZ572 engines
- Chrome breathers are 1-3/8" hose-clamp-style with the Bowtie logo on top
- Installs on the left side of each valve cover
- Kit includes 2 breathers



12341993
Push-In Oil Filler Cap

- For valve covers with 1.22" hole



19131218
Chrome Push-In Breather (not shown)

- 2-3/4" O.D. x 1-1/2" tall with 3/8" nipple
- Used on our Fast Burn 385, ZZ4 and 350 engines

12341986
Hold-Down Clamps

- Clamps to minimize distortion of valve cover flanges on 1955-1986 Chevrolet Small-Block V-8 and 90° V-6 engines
- 4 clamps per package; order 2 per engine



14082321
Spring Bar Retainer

- Special steel retainers prevent oil leaks
- Use under the valve cover bolts
- Distribute clamping force over a large area and prevent deformation of the flanges
- Narrow retainers are engineered to fit pre-1986 engines with perimeter-style hold-downs



NOTE: Package contains 1 retainer. Order 4 per valve cover.

 **Valve Covers: Additional Required Components**

Part Number	Gaskets (Qty)	Bolts (Qty)	Grommets (Qty)	Oil Fillers (Qty)	Engine Application
25534359	10046089 (2)	N/A	3989350 (1)	93439687 (1)	19435602, 19435604
12497979	10046089 (2)	12497980 (8)	12341988 (8)	N/A	Small-Block
12497985	10046089 (2)	12497980 (8)	12341988 (8)	N/A	Small-Block
12497978	10046089 (2)	12497980 (8)	12341988 (8)	N/A	Small-Block



Additional components required for installation. See chart above.



SMALL-BLOCK COMPONENTS

Adapters, Hardware and Breathers continued

14044820

Spring Bar Retainer, Chrome-Plated



- Similar to retainer P/N 14082321 described on previous page
- Chrome-plated to match chrome valve covers

NOTE: Package contains 1 retainer. Order 4 per valve cover.

3933964

Valve Cover Gasket (not shown)

- Cork-type gasket
- Fits all valve covers with perimeter hold-down bolts
- 1 gasket per package

10046089

Valve Cover Gasket (not shown)

- For 1986 and newer center hold-down design valve covers

PUSHRODS

Pushrods are that critical connection between the camshaft and the rocker arms. These seemingly innocuous parts play a very important role in the combustion process. That's why Chevrolet Performance pushrods are designed for heavy-duty street and competition applications. They are case-hardened for use with pushrod guideplates.

Pushrods are available in standard and .100-inch extended lengths. The longer pushrods can be used to restore correct valvetrain geometry when using a high-lift camshaft with a small base circle. They are also recommended when longer-than-stock valves are installed.



Heavy-Duty Pushrod Kit (.100" longer than stock)

Part Number	Material	Diameter	Length	Usage	Description
366277	1010 steel	5/16"	7.824"	Flat tappet	(1) Heavy-duty heat-treated .075" wall, hardened tip inserts; +.100" long
10046173	1010 steel	5/16"	7.122"	Hyd. roller	(1) Heavy-duty heat-treated .060" wall, standard length; For use in early ZZ-series engines with guideplates
12371041	1010 steel	5/16"	7.122"	Hyd. roller	(16) Heavy-duty .060" wall, standard length; For use in 2nd design ZZ-series engines without guideplates; Use P/N 10241740 for single piece
10241740	1010 steel	5/16"	7.122"	Hyd. roller	(1) Heavy-duty .060" wall, standard length; For use in 2nd design ZZ-series engines without guideplates

GUIDEPLATES

3973418

Pushrod Guideplate – Cast-Iron Head (not shown)

- For use with production and Bowtie cast-iron cylinder heads with screw-in studs
- Can also be used with aluminum Bowtie V-6 head
- Should not be used with self-aligning rockers
- Pushrod slots are .325"
- For 90° V-6, use on cylinders 1, 2, 5 and 6; guideplate must be ground to clear valve cover hold-down bolts
- 4 required per head

ROCKER ARM STUDS

3921912

Screw-In Rocker Stud – 7/16" Big-Block Style (not shown)

- Beefy 7/16" Big-Block V-8 rocker studs
- Improve valvetrain stability of any Small-Block V-8 or 90° V-6 racing engine by minimizing rocker stud flex
- Fits any Small-Block V-8 or 90° V-6 cylinder head machined for screw-in studs
- Requires rocker arm for 7/16" stud

12371058

Screw-In Rocker Stud Kit – Gen II LT1, LT4 Style



- 7/16" studs are used on all late-model Gen II LT1 and LT4.
- Kit includes 16 pieces; for single stud usage, use P/N 12552126
- Lower thread section is 7/16"-14

VALVE LIFTERS AND COMPONENTS



19435433

Hydraulic Roller Lifter Kit

- Designed for 1986-and-later engines
- Second-design lifters are used in late-model 350 HO engines and use a higher checkball spring preload
- Includes 16 lifters, 8 valve lifter guides, 1 valve lifter guide retainer and 3 flange-head bolts
- This lifter kit plus pushrod kit P/N 12371041 and a roller-tappet design camshaft converts your engine to a roller-lifter engine
- For single lifter usage, use P/N 17120735

88958652**Valve Lifter Guide – “Quick Cam”**

- For use on Gen I GM Small-Blocks (block must be drilled and tapped)
- For use with hydraulic roller lifters only
- Makes it possible to remove the camshaft without removing the intake and lifters
- Enough friction in the guide to hold the lifters in place if the rocker arms are backed off and the camshaft is rotated two full revolutions to push up the lifters

NOTE: Package services one lifter bank.

12371044**Hydraulic Lifter Kit (set of 16)**

- Used on 1986-and-older Gen I and Gen II-style engines
- Kit includes 16 hydraulic flat tappet lifters and is designed for use with standard-length pushrod kit or .100" kit
- Use P/N 5232720 for single lifter pieces

**CAMSHAFTS AND COMPONENTS**

A great deal of exacting engineering, extensive development/testing and precision manufacturing practices go into every Chevrolet Performance camshaft. In many ways, the camshaft can be considered the heart of a high-performance engine. This vital function is why Chevrolet Performance puts so much effort into making sure its camshafts deliver maximum power and drivability.



IMPORTANT! Distributor with melonized steel gear **MUST** be used with steel camshafts or engine damage will occur.

Part Number	Description	Duration @ .050" Lift (deg)	Maximum Lift (in)/w/1.5 rocker*	Lobe Centerline (deg)	Technical Notes
3896962 🏆	Hydraulic flat tappet	I: 222 / E: 222	I: .450 / E: .460	114	Used in -350/290 HP crate engine
24502476 🏆	Hydraulic flat tappet	I: 212 / E: 222	I: .435 / E: .460	112.5	Used in 350 HO and CT350 engines
14097395 🏆	Hydraulic roller design	I: 196 / E: 206	I: .431 / E: .451	109	For the HT383 truck engine with 1.5 rockers
10185071 🏆	Hydraulic roller tappet	I: 208 / E: 221	I: .474 / E: .510	112	For 350 HO, SP350/385 and ZZ6; Use with spring P/N 12551483
24502586 (1.5 rocker) 🏆	Hydraulic roller (Gen II LT4 hot cam)	I: 218 / E: 228	I: .492 / E: .492	112	Service only, for all V-8 engines with roller cams (see note below chart)
24502586 (1.6 rocker) 🏆	Hydraulic roller (Gen II LT4 hot cam)	I: 218 / E: 228	1.6 rocker I: .525 / E: .525	112	Service only, for all V-8 engines with roller cams (see note below chart)
12480002 (1.6 rocker) 🏆	Hydraulic roller (Gen II LT4 hot cam kit)	I: 218 / E: 228	1.6 rocker I: .525 / E: .525	112	Same as P/N 24502586 except this is a kit that includes 1.6 ratio aluminum rockers, valve springs, and retainers (see below for content)
19210723 🏆	Hydraulic roller design	I: 222 / E: 230	I: .509 / E: .528	112	Contains eccentric for mechanical fuel pump
19244485 🏆	Hydraulic roller design	I: 234 / E: 242	I: .539 / E: .558	112	Contains eccentric for mechanical fuel pump

*Unless otherwise specified

NOTE: The Gen II LT4 camshaft P/N 24502586 was designed to be used in many different engines. The following change may be necessary for correct engine assembly: For LT1 and L98 engines (pre-1996) the dowel pin in the end of the camshaft must be pushed in so extension from end of cam is .30" +/- .01". For 1996 LT1 and LT4 engines, the dowel pin is in the correct position extending .620" from the end of the camshaft. This cam has a fuel pump lobe.

CAMSHAFT KITS, RETAINERS AND REAR COVER KITS

Part Number	Description	Technical Notes
10088128	Camshaft Retainer (not shown)	First design with 3.620" bolt center as used on ZZ1 and ZZ2 engines
10168501	Camshaft Retainer (not shown)	Second design with 3.294" bolt center as used on ZZ3 and ZZ4 engines

12480002 🏆**350 Hot Cam Kit**

Off-highway kit converts production Gen II LT1 engines for showroom stock racing. Improves Small-Blocks originally equipped with roller tappet camshafts for significant horsepower gains. For roller lifter blocks only. Kit includes 1 camshaft (P/N 24502586), 16 rocker arms (P/N (P/N 24502586), 16 valve springs (P/N 12551483), 16 retainers (P/N 19169661), 16 valve keys (P/N 24503856) and 16 valve spring shims (P/N 10212809). Lifters are not included (re-use original roller lifters).



Parts intended for competition use only. See page 2 for details.



Performance

155

CONNECTING RODS AND COMPONENTS

Part Number	Description	Technical Notes
19435211	Connecting Rod Kit	High-quality, 5.700" powdered metal (PM) connecting rods; For applications below 500 horsepower; Replaces the old "pink rods" and are the same rods used in Gen II LT1 and LT4 Corvette engines; Includes 8 P/N 19435115 rods, available individually
19355718	383 Connecting Rod Kit – 3rd Design (not shown)	383-cubic-inch engines, third design; PM rod machined for clearance; Standard .927" pin and 2.100" rod journal; Uses standard bolt and nut
17800761	Connecting Rod Bearing Kit – 350 and 383 Engine (standard)	8 heavy-duty bearing sets, second design, without chamfer; For all 383-cubic-inch engines
12491166	Connecting Rod Stud and Nut Kit – 383 Engine	Studs and 12-point nuts (16 each) for all 383-cubic-inch engines; Use with connecting rod P/N 19355718

PISTONS AND PISTON RINGS

Compressing the air/fuel mixture and dealing with the explosive forces inside an engine's cylinders isn't a job for weak parts. That's why Chevrolet Performance pistons are premium quality and factory-tested to withstand the rigors of high-performance competition engines. Chevrolet Performance pistons are available in a variety of compression ratios and bore sizes. They're sold individually, unless otherwise specified, and wrist pins are included.

Pistons 

Part Number	Engine Size	Compression Ratio	Head Chamber Volume	Size	Pin Type	Technical Notes
19434034	350	10:1	58cc	Standard	Pressed	5.7L HO, ZZ4 and LT1; high silicon aluminum
88962749	383	9.1:1 / 9.7:1*	64cc / 62cc	+0.030"	Pressed	383 engine, first or second design
12499104	383	9.1:1 / 9.7:1*	64cc / 62cc	+0.030"	Pressed	Kit containing 8 of P/N 88962749 (383 engine, second design)

*Compression ratio based on .028" thick head gasket.

Piston Rings 

Part Number	Bore Size	Oversize	Ring Thickness	Description
12499136	4.000"	+0.030"	–	Premium quality rings for 383 engines
19418376	4.000"	+0.005"	–	Set of 8 ring packs
12499231	4.000"	Standard	–	Set of 8 ring packs of P/N 12528817

CRANKSHAFTS

A crankshaft is that massive piece of convoluted steel that holds the whole engine together. An engine is essentially a pump, and without a strong crankshaft, the pump won't work. Chevrolet Performance puts the same top-quality engineering and manufacturing processes into its crankshafts as it does all its parts. These crankshafts are the same ones used in Chevrolet Performance crate engines. The crankshafts are available in cast iron and forged steel. Forged crankshafts should be used for higher-horsepower applications.



Part Number	Description	Technical Notes
14088526	Crankshaft, Cast Iron (not shown)	Nodular cast iron with 3.480" stroke and 2.100"-diameter rod journals; 1-piece rear main seal crankshaft for 300- and 330-horsepower engines; NOTE: This crank does not have a pilot bearing
12670965	Crankshaft, Forged Steel (used in late-style ZZ4, ZZ5 and ZZ6 engine; not shown)	Forged 1053 steel crankshaft used in post-November 1998 ZZ4 engines; Replaces all cast or steel ZZ4 crankshafts NOTE: Must be used with connecting rod P/N 10108688 or 19435115 and piston P/N 19434034
12489436	Crankshaft, 383-Cubic-Inch Forged Steel (shown above)	Forged 4340 steel crankshaft used to create 383-cubic-inch engines with 3.800" stroke; Rod journals are 2.100"; Mains are standard 350 size; NOTE: Should be used with connecting rods P/N 19169670, bearing kit P/N 17800761, standard pistons P/N 88962748 or .030" oversize pistons P/N 88962749, balancer P/N 12498008, and 1986-and-later 1-piece crank seal design flywheel or flexplate
14061685	Roller Pilot Bearing (not shown)	Used in high-performance manual transmission applications

BALANCERS AND PULLEYS

Balancers are relatively small parts that play a big role in how smooth an engine runs. Balancers are also known as torsional dampers or harmonic balancers, which is indicative of how they help control unwanted crankshaft vibrations. By controlling vibrations, Chevrolet Performance balancers help engines run smoothly, which can also help extend engine life.



ZZ6 and CT400 Engine Balancer

383 Crate Engine Balancer
w/1-Piece Crank Seal

Small-Block Balancers

Part Number	Engine Application	Outside Diameter	Technical Notes
12551537	1969-up 305 and 350; 90V-6 competition (not shown)	6.750"	Smaller size for limited clearance; Timing mark is 10 degrees before keyway centerline; Use with timing pointer P/N 3991435
19301706	1970-1974 350; ZZ6 and CT400 crate engine	8"	Nodular iron. Inertia ring is 1- ¹ / ₈ " wide
12498008	383 crate engine with 1-piece crank seal	8"	Use with 383 engine components and crankshaft P/N 12489436; For externally balanced engines; Counterweight can be removed for neutral balance

Pulleys and Bolts

Part Number	Description	Technical Notes
19355269	Crankshaft Pulley, 6- ⁵ / ₈ " (not shown)	Two-groove, high-rpm, 6- ⁵ / ₈ " pulley. For engines with short water pump; NOTE: Can be used with a water pump pulley and belt P/N 9433722 without an idler pulley or alternator.
9440024	Crankshaft Bolt (not shown)	Positive retention ⁷ / ₁₆ "-20 x 2- ¹ / ₄ " bolt for engines with tapped crank snouts; Use with washer P/N 14001829

FLYWHEELS AND FLEXPLATES

At the opposite end of the crankshaft from the balancer are flywheels and flexplates, which connect the engine to either manual (flywheels) or automatic (flexplates) transmissions. Chevrolet Performance offers both internally and externally balanced flywheels and flexplates. It is critical that you use the correct design for your engine application.

IMPORTANT: All Chevy Small-Block and Big-Block engines with one-piece crankshaft seals require an externally balanced flywheel or flexplate.



14" Flywheel, 1986-up



14" Flexplate

Small-Block Flywheels

Part Number	Year of Engine	Outside Diameter	Crank Flange Bolt Pattern	Clutch Diameter	Starter Ring Gear Teeth	Technical Notes
14088648	1986-up	14"	3.000"	11.000"; 11.850"	168	For 1-piece crank seal

Small-Block Flexplates

Part Number	Year of Engine	Outside Diameter	Crank Flange Bolt Pattern	Clutch Diameter	Starter Ring Gear Teeth	Technical Notes
471598	1955-1985	14"	3.580"	10.750"; 11.500"	168	For internally balanced engine with 2-piece crank seal
471529*	1955-1985	12.750"	3.580"	9.750"; 10.750"	153	For internally balanced engine with 2-piece crank seal
14088765*	1986-up	12.750"	3.000"	10.750"	153	For externally balanced 1-piece crank seal
14088761	1986-up	14"	3.000"	10.750"; 11.500"	168	For 1-piece crank seal, externally balanced

*Will not work with new SuperMatic™ torque converters

Bolts

Part Number	Description	Technical Notes
12337973	Flywheel Bolt (not shown)	Fits all Chevy Small-Block V-8, Big-Block V-8 and 90° V-6 engines; Sold individually; 6 required per engine
3727207	Flexplate Bolt (not shown)	Fits all Chevy Small-Block V-8, Big-Block V-8 and 90° V-6 engines; Sold individually; 6 required per engine

TIMING CHAINS AND SPROCKETS

The timing chain connects the crankshaft to the camshaft and helps to ensure those two key components work in a synchronized manner. Chevrolet Performance's strong, accurate timing chains and sprockets provide performance and dependable service.



Single Roller Timing Chain Kit



Extreme-Duty Timing Chain Kit – LT1 and LT4 Engines



LT1/LT4 Front Cover Plug



Camshaft Bolt

Part Number	Description	Technical Notes
12371043	Single Roller Timing Chain Kit	Performance kit for all 1987-and-newer engines with roller lifter camshaft, except LT1, LT4 and LS-Series; Includes chain P/N 14088783, crank sprocket P/N 14088784, cam sprocket P/N 12552129, retainers and bolts; NOTE: Will not work with flat tappet camshafts or LT1 and LT4 engines.
12370835	Extreme-Duty Timing Chain Kit – LT1 and LT4 Engines	Performance upgrade, extreme-duty timing chain kit for Gen II 1995-and-newer LT1 and LT4 engines; Includes roller timing chain P/N 14088783, crankshaft sprocket P/N 14088784 and water pump gear P/N 12551728; Use with pin-drive camshaft only
14088783	Roller Timing Chain (not shown)	Heavy-duty single-roller chain for ZZ-design 350 HO engine; Use with crank sprocket P/N 14088784 and cam sprocket P/N 12552129
14088784	Crankshaft Sprocket (not shown)	Single-roller type for ZZ-design 350 HO engine
12552129	Camshaft Sprocket (not shown)	Single-roller type for ZZ-design 350 HO engine
9424877	Camshaft Bolt	5/16" - 18 x .750" bolt (3 required)
12554553	Camshaft Dowel Pin (not shown)	
12367600	LT1/LT4 Front Cover Plug	Covers the hole on the front cover of a 1996 LT4 engine when original distributor is removed and replaced with rear-mounted distributor; Must be used with 1995 to 1997 timing covers; Will not fit the earlier covers that had non-vented opti-spark units

WATER PUMPS, PULLEYS AND COMPONENTS

Water Pump – Long-Style



Aluminum Water Pump – Short-Style



Part Number	Description	Technical Notes
12685965	Water Pump – Long-Style	Clockwise (standard) rotation; Late-style cast-iron pump with long mounting legs, reinforced snout and 3/4" diameter shaft; End of shaft is reduced to 5/8" diameter; Use with 350 HO, 383 and ZZ4 engines
19418012	Aluminum Water Pump – Short-Style	Saves weight over comparable iron pump; Casting has short-style mounting legs used on pre-1982 Corvettes; Pump has reinforced 3/4" diameter snout and a large hub with dual bolt patterns NOTE: Pump housing has a boss, which can be drilled and tapped for a cam stop; Can be used with the ZZ4 engine with composite front timing cover by exchanging the bolts that hold the rear sheet metal plate to the pump with pan-head bolts or equivalent aftermarket bolts. NOTE: Cam stop boss may interfere on engines with 8" damper. Some clearancing may be required.
89060527	Water Pump, Cast Iron (not shown)	Counterclockwise (reverse) rotation, or use with a Chevrolet Performance Serpentine Accessory Drive; Used in Chevrolet Performance Front-End Accessory Drive Kits and on Turn-Key engines

ACCESSORY DRIVE SYSTEMS

19435736

Serpentine Accessory Drive System – with Air Conditioning

- Fits Gen I-style engines
- Deluxe kit includes all the components and hardware necessary to install on an engine with air conditioning, including water pump, alternator, power steering pump and idler bracket; belt included

19435737

Serpentine Accessory Drive System – without Air Conditioning (not shown)

- Fits Gen I-style engines
- Deluxe kit includes all the components and hardware necessary to install on an engine without air conditioning, including water pump, alternator, power steering pump and idler bracket; belt included
- Includes all components from above kit, minus air compressor assembly

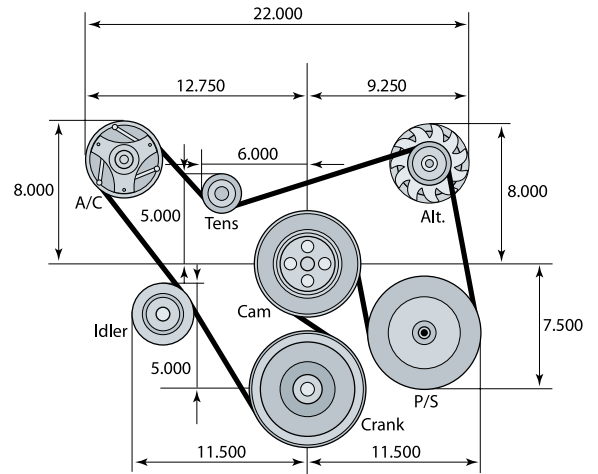

Serpentine Accessory Drive System – with Air Conditioning

OIL PANS, GASKETS AND COMPONENTS

Oil is your engine’s lifeblood and a high-quality Chevrolet Performance oil pan helps keep it where it belongs. Our properly designed and manufactured oil pans fit right and, along with matching gaskets, help prevent oil leaks. Chevrolet Performance has oil pans for street and competition applications.

(Oil pans are sold without dipsticks or other hardware unless otherwise specified.)

NOTE: Chevrolet V-8 and V-6 engines were redesigned in 1986 to include a one-piece rear main seal. That change required a correspondingly new oil pan design. For pre-1986 engines, there is a newer one-piece pan gasket available. Oil pans and gaskets are not interchangeable between early and late design engines. Blocks that have been machined for a one-piece rear main seal require seal adapter and must use the newer-style oil pan and gasket.



Oil Pan – 1986–1992 F-Car and ZZ4

Circle Track "Late Model" Oil Pan

Windage Tray

Windage Tray

Part Number	Description	Technical Notes
12557558	Oil Pan – 1986–1992 F-Car and ZZ4	4-quart pan used on ZZ4 crate engines and 1986–1992 Camaro and Firebird; Internal baffling and right-hand dipstick; Designed for 1-piece rear main and 1-piece oil pan gasket; NOTE: Use with oil pan rail reinforcement P/N 12553059 (RH).
25534353	Circle Track "Factory Stock" Oil Pan (not shown)	Special black-powder-coated, 8-quart circle track pan is used in the factory stock engines P/N 19435604; 7" sump has a 3.500" kickout on both sides; Includes a fully louvered windage tray, 3 crankshaft scrapers, 6 trap doors, 2 runners, an oil temperature fitting provision, oil level plug, and 5/8" oil pick-up tube; 7" deep; Oil pickup tube available separately P/N 19171997
25534354	Circle Track "Late-Model" Oil Pan	Special black-powder-coated, 8-quart circle track pan is used in the factory stock engines P/N 19435604; 7" sump has a 3.500" kickout on both sides; Includes a fully louvered windage tray, 3 crankshaft scrapers, 6 trap doors, 2 runners, an oil temperature fitting provision, oil level plug, and 5/8" oil pick-up tube; 7" deep; Oil pickup tube available separately P/N 19171997
10108676	Oil Pan Gasket – 1-Piece Rear Main Seal (not shown)	Neoprene 1-piece gasket for 1986-and-newer engines
3927136	Windage Tray	Separates the oil in the pan sump from the rotating crank assembly to reduce aeration of the oil; Aids in oil control and minimizes oil slosh under hard braking; Use with oil pan P/N 360450
12554816	Windage Tray	Flat oil pan baffle used with 1986–1996 Corvette pan; For 1968-and-newer blocks, use five mounting studs P/N 14087508

OIL PUMPS & FILTERS

Oil Pump, High Volume



Oil Filter Adapter



Part Number	Description	Technical Notes
93427692	Oil Pump, High-Pressure Gen II LT1/LT4-Style (not shown)	Production-style high-pressure 1993–1997 LT1/LT4 oil pump with 1.200" gears; Produces 60–70-psi oil pressure; Screen not included
14044872	Oil Pump, High Volume	High-volume pump has 1.500" gears for increased volume; Approximately 25 percent more capacity than a production pump at standard pressure; Pick-up not included
10046007	Oil Pump Bolt (not shown)	Fits all models, 7/16"-14 x 2-3/8"
3998287	Oil Pump Shaft (not shown)	Fits all 1959-and-newer engines
3764554	Oil Pump Shaft Retainer (not shown)	Fits all 1959-and-newer engines; Use with oil pump shaft P/N 3998287
3848911	Oil Pump Spring (not shown)	Regulates oil pressure at approximately 70 psi; Use with high-volume pump P/N 93427692 NOTE: Minimum recommended oil pressure for off-highway use is 65 psi at engine operating speed.
19299222	Oil Filter Adapter	Mounts a spin-on cartridge for Gen I and II Small-Block V-8s; Contains a filter bypass valve and requires two attaching bolts, P/N 3951644

DISTRIBUTORS AND COMPONENTS

High-quality, durable and dependable Chevrolet Performance distributors optimize the performance of your GM engine. These distributors are interchangeable among standard GM Small-Block and Big-Block V-8s. For tall-deck engines, use adjustable slip collar distributor P/N 10093387.

NOTE: Melonized distributor gear P/N 10456413 is required on all Chevrolet Performance crate engines, or serious damage will occur.



Distributor – HEI

Distributor –
Ram Jet 350 & Ram Jet 502Distributor –
Adjustable Slip Collar

Part Number	Description	Technical Notes
19432312	Distributor – HEI	Cast-aluminum distributor for all Small-Block and Big-Block V-8 engine assemblies; High-performance mechanical advance curve; Vacuum advance canister included; Use connector P/N 12167658 to attach tachometer and 12-volt power supply wire to distributor; Includes module P/N 19180771, cap P/N 19110931 and rotor P/N 19110934
19420969	Distributor – Ram Jet 350 and Ram Jet 502	Used on the fuel-injected Ram Jet 350 and Ram Jet 502; Includes ignition module P/N 19352928, cap P/N 19166099 and rotor P/N 10477219
19420927	Distributor – Late-Model EFI (not shown)	Used on late-model V-8 engines with fuel injection and computer controls; Kit includes ignition module, cap and rotor
10093387	Distributor – Adjustable Slip Collar	Billet aluminum housing; Ball-bearing guide; Adjustable mechanical advance; Magnetic pickup; Uses standard cap and rotor; Adjustable slip collar for tall-deck blocks or to compensate for cylinder head or block machining
19432518	Distributor Gear (not shown)	Regulates oil pressure at approximately 70 psi; Use with high-volume pump P/N 93427692 NOTE: Minimum recommended oil pressure for off-highway use is 65 psi at engine operating speed.
19432310	Distributor Gear (not shown)	Melonized gear for distributor P/N 19420927
12167658	Connector – HEI Distributor Power and Tachometer (not shown)	Used to attach the power and tachometer wires to the cap of the HEI distributor
12498335	Coil – HEI (not shown)	Production HEI coil

BUILDERS TIP

Small-Block Oil Pump Overkill

Over the years, many engine builders have employed Big-Block oil pumps on high-performance Small-Blocks. Unless you're building a dedicated racing engine, that's not necessarily a great idea. There are advantages to the Big-Block pump, but with its 3/4" pickup tube, it's very easy to suck all the oil out of a standard-capacity Small-Block oil pan, starving the engine at higher rpm. If you're going to try the Big-Block pump, make sure to use a large-capacity pan and don't let the oil level get low!

Intake Manifolds, Gaskets and Components

Intake manifolds distribute the air/fuel mixture to the appropriate cylinders. Intake manifold design is geared toward all-out competition application. The wide range of Chevrolet Performance intake manifolds means there is an ideal manifold for your needs. There are cast-iron and aluminum intake manifolds for carbureted and fuel-injected applications. Chevrolet Performance intake manifolds were designed specifically for GM engines, so you know they will deliver GM performance.

SMALL-BLOCK INTAKE MANIFOLDS

10185063

Intake Manifold – ZZ Series

- Can be used on all Small-Blocks through 1986
- Dual-pattern carburetor flange is approximately 1/2" lower than the 1970 LT1 intake, yet produces the same horsepower
- Provisions for all late-model accessory brackets, EGR, and an integral hot-air choke
- A heat shield can be mounted underneath for improved performance

NOTE: Open carburetor spacer is not recommended for use with dual-plane intake manifolds.



12366573

Intake Manifold – Vortec Head Design

- Designed for 283–400-cubic-inch engines using Vortec cylinder heads P/N 12691728, P/N 19431662, P/N 19417592, P/N 19331470 or P/N 19331472
- Has 4 bolts per side to attach it to these cylinder heads
- Aluminum high-rise design maximizes horsepower and delivers a broad torque curve
- Accepts a square-bore 4150-style carburetor and includes externally plumbed hot water crossover passage
- Use manifold gasket P/N 89017465 and 8 attachment bolts, P/N 12550027

NOTE: Vortec heads were originally released on 1996–1999 truck engines. Check for hood clearance, especially with Corvette.

NOTE: Open carburetor spacer is not recommended for use with dual-plane intake manifolds.

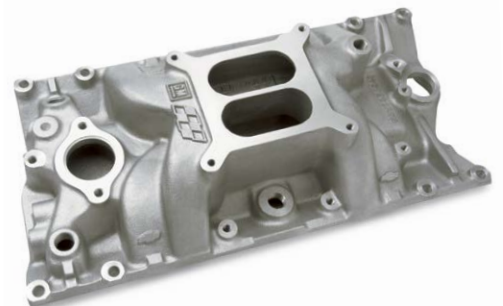

12496820

Intake Manifold – Vortec Head Design (Dual-Pattern Carb Mount)

- This dual-bolt-pattern aluminum manifold will work with all Vortec cylinder heads P/N 12691728, P/N 19431662, P/N 19300995, P/N 19331470 or P/N 19331472
- Will accept Holley or Quadrajet-style carburetors
- To block EGR port, use P/N 12556596
- Requires intake manifold gasket kit P/N 19301685 and 8 special manifold bolts, P/N 12550027

NOTE: Open carburetor spacer is not recommended for use with dual-plane intake manifolds.



12496821

Intake Manifold – Vortec Head Design for TBI

- Designed for throttle-body fuel injection
- Aluminum intake will work with all Vortec cylinder heads, including P/N 12691728, P/N 19431662, P/N 19417592, P/N 19331470 and P/N 19331472
- Also accepts EGR

NOTE: The exhaust manifold from 1996–and-newer pickup trucks with RPO L31 350 engine, P/N 12557828, is drilled and tapped to accept an EGR tube. EGR pipe can be used with EGR valve P/N 19210662 and gasket P/N 12337972. This manifold is primarily intended for use with Vortec heads on pre-1996 engine blocks. Blocks manufactured in 1995 or earlier have thermostat bypass passage from the block directly to the water pump. If manifold is used on 1996 and later engines (which do not have the bypass in the block), you must run a coolant bypass line from the manifold to the 3/8" hose nipple on the water pump (passenger's side). Suggested routing is from the 3/8" NPSF boss on manifold to the water pump.

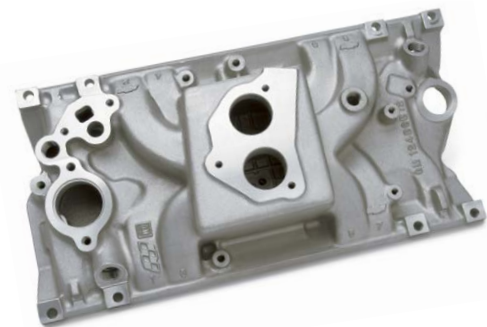

Parts intended for competition use only. See page 2 for details.



Additional components required for installation. See chart on page 163.



Performance

161

SMALL-BLOCK COMPONENTS

Small-Block Intake Manifolds continued

12496822

Intake Manifold – Eliminator Vortec Head Design

- Designed to deliver the most power and torque with Vortec cylinder head P/N 12691728, P/N 19431662, P/N 19417592, P/N 19331470 or P/N 19331472
- Use intake manifold gasket kit P/N 19301685 and 8 special manifold bolts, P/N 12550027



24502592

LT1 Intake Manifold

- Fits 1992–1996 Gen II LT1 engines and permits the use of a carburetor
- Long runners increase engine torque up to 30 lb.-ft. without sacrificing top-end horsepower
- There are no water coolant holes on this manifold



12676887

SP 350/357 Dual-Plane Intake Manifold (not shown)

- Original equipment on SP 350/357 engine
- Dual-Plane design for maximum torque
- Designed for 4150-style 4 bbl carb
- Fits late-model Vortec style heads
- Do not use a carb spacer with this manifold

NOTE: Open carburetor spacer is not recommended for use with dual-plane intake manifolds.

BOWTIE COMPETITION MANIFOLDS

24502481

Intake Manifold – 18° Competition

- Weight 22.5 lbs
- Volume 2700cc
- Developed for Asphalt short tracks and works well on Trans-Am-series engines
- Features smaller runners and less plenum volume, which enhances mid-range torque
- Aluminum intake fits 18° heads casting
- Manifold is ideal for 310-cubic-inch road racing and 358-cubic-inch short track engines
- Manifold flanges are .590" thick to promote a good gasket seal
- An auxiliary water line boss at the rear of the casting improves water flow



24502653

Intake Manifold – Spider Design

- A 2-piece "dry" aluminum manifold "spider" consisting of the runners and plenum only
- The runners (called the spider assembly by racers) along with Valley Plate Assembly—the common term for the bottom section of the intake (see P/N 24502654)—are designed for use with the 18° cylinder heads with a date code of June 1996 or newer



24502654

Valley Plate Assembly

- Universal aluminum valley plate is designed for use with 18° cylinder heads
- Can be used with dedicated 2-piece manifold spiders, existing 1-piece intake manifolds that have been properly machined for use as a dry manifold, or fabricated manifold designs
- Valley plate has cast-in integral passages to equalize coolant flow from the front and the rear of the cylinder heads
- Fits heads dated June 1996 and later



Important information about gasket matching: Gasket flanges are machined to provide the proper port alignment with standard runner locations. Runners in heads and manifold must be matched by engine builder. Often, the gasket will line up with the top of the port so removal is required at the bottom of the port. Gaskets that can be used with this manifold are: Fel-Pro® P/N 1205 and P/N 1206, and Mr. Gasket® P/N 102. Always match the gasket to the cylinder head you plan to use to ensure a correct fit.

NASCAR INTAKE MANIFOLDS

88958617

Intake Manifold – Spider Design, SB2.2

- Designed for NASCAR-style racing and high-rpm engines
- Additional aluminum in the runners and plenum allows more flexibility in porting
- Must be used with Valley Plate Assembly P/N 12370840 or P/N 88958659



88958659

Valley Plate Assembly – SB2.2

- Aluminum valley cover is used with manifold runners P/N 12480096, P/N 88958617 and P/N 88958691
- Does not incorporate an inspection cover, but has revised integral water passage for improved coolant flow from the front and rear of the cylinder heads
- Uses AN-24 fitting for water outlet; can use reducer for -20 fitting



88958670

Valley Plate Assembly – ROX (not shown)

- Fits ROX manifold and ROX head P/N 88958667

COVERS AND PLUGS

6269414

Cover – EGR Valve

- Covers the EGR valve port on the 350 HO manifold P/N 10185063
- Use gasket P/N 12554530 and screw P/N 9442184 with washer P/N 9439511



WATER NECKS

10108470

Aluminum Water Outlet (not shown)

- Natural finish

12342024

Chrome Water Neck

- Chrome water neck with neoprene O-ring and chrome bolts
- For 1966–1975 full-size Chevrolet, Camaro, and Chevelle V-8 engines



INTAKE MANIFOLD GASKETS

10147994

Gasket Kit – 1971–1986 and ZZ350



- For 302–350 high-performance Small-Blocks built 1971–1986, and all ZZ350 high-performance engines
- Gaskets fit standard intake port location
- Do not use with raised runner cylinder heads
- Includes 2 gaskets

19301685

Gasket Kit – Fast Burn Aluminum Vortec Design



- Designed for Vortec heads P/N 12691728 and P/N 19431662 only
- Gasket thickness is .120" (1/8"), post size is 1.080" x 2.160" with tapered wall, Print-O-Seal design
- Has both early style 6-bolt pattern and Vortec 4-bolt pattern
- Includes 2 gaskets

89017465

Gasket Kit – Production Vortec Design

- Production gasket for all Vortec-design cylinder heads (4-bolt attachment to cylinder heads P/N 12558060 and P/N 12691728)

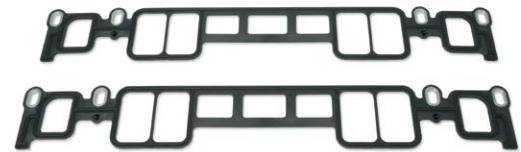

- Requires the use of GM attachment bolt P/N 12691728, because the bolt has a ball design on the end that seats in the head so it will not crush the intake manifold gasket
- Includes 2 gaskets

10185007

Gasket Kit – 18-Degree High Port Heads (not shown)

- Used only with V-8 18° high port cylinder heads
- Includes 2 gaskets

12524653

Gasket Kit – LT1 4-bbl Conversion (not shown)

- Required when installing a 4-bbl manifold on any LT1 engine
- Includes 2 gaskets



Intake Manifolds: Additional Required Components

Part Number	Gaskets (Quantity)	Bolts (Quantity)	Engine Application
12366573	89017465 (1)	12550027 (8)	19435602, 19433041, 19433042
12496820	89017465 (1)	12550027 (8)	19433031, 19433036, 19433038
12496822	89017465 (1)	12550027 (8)	19435604, 19433041, 19433042, Vortec Heads
10185063	19367332 (1)	14091544 (8), 88891769 (2)	
12489371	89017465 (1)	12550027	19417619
12496821	89017465 (1)	12550027 (8)	Vortec Head for TBI
24502481	10185007	N/A	18° high-port racing heads
24502653	10185007	N/A	18° high-port racing heads
24502654	10185007	N/A	18° high-port racing heads



Additional components required for installation. See chart above.



Electrical and Fuel Components

STARTERS

Flywheels with two different diameters are used on Chevrolet Small-Block, Big-Block, and 90° V-6 engines. Large flywheels are 14" in diameter and have 168 teeth on the starter ring gear. Small-diameter flywheels are 12.75" in diameter, with 153 teeth on the ring gear.

This difference in flywheel diameters requires two distinct starter housings. Starter noses used with large-diameter flywheels have two offset bolt holes, while starters for small flywheels have two bolt holes that are parallel to the back of the block. Most Chevy blocks are drilled for both types of starters.

19433448 ⓘ

High-Torque Mini Starter

- Gear reduction starter is designed for 1958–1996 V-8 and all 90° V-6 engines
- Compact design provides increased clearance
- Weighs only 10.5 pounds and has a gear reduction of 3.75:1
- Equipped with a dual bolt pattern for 12.750" (153-tooth) and 14" (168-tooth) flywheels
- Housing can be rotated to clear exhaust systems
- Includes starter, mounting bolts, shims, gaskets and electrical connectors



NOTE: Not recommended for competition use.

12363128 ⓘ

High-Torque Mini Starter – Chrome

- Same as starter P/N 19433448 (see above), but with a chrome housing



10465143 ⓘ

Lightweight Starter (remanufactured)

- Lightweight high-performance starter was originally used on 1993–1997 Camaros and Firebirds with the LT1 engine
- Can be used on any Small-Block or Big-Block engine with a 12.750", 153-tooth flywheel



19302919 ⓘ

Lightweight Starter – Big-Block and Small-Block

- Gear reduction starter can be used on Big-Block and Small-Block engines with a 14", 168-tooth flywheel



CHASSIS WIRING HARNESS

If you're building a hot rod or restoring an old muscle car, Chevrolet Performance inclusive wiring harness kits make a great replacement for old, worn or damaged wires. These universal wiring kits come with the wires pre-installed on the fuse block, so wiring the vehicle is simply a matter of mounting the fuse block and routing the wires. Each wire is preprinted with the necessary application and is GM-color-coded. The kits also come with all necessary fuses, flashers, horn relay, tach leads, wire ties and grommets. High-temperature 275°F wire is used—one size larger than factory specs. In all, it's everything you need to electrify your vintage GM car or truck!

12355691

12-Circuit Wiring Harness (not shown)

Basic system is wired for: heat/air conditioning, brake lights, coil, electric fan, emergency flashers, gauges/dash instruments, headlamps, horn, radio, turn signals, wipers, dome light and third brake light

NOTE: These universal systems will rewire any car, truck or competition vehicle using a GM-keyed column. Kits come with extra-long wire to accommodate almost any vehicle.

SPARK PLUG WIRES

19433385 ⓘ

Chevrolet Bowtie Logo Wires

Chevrolet Performance spark plug wire kits are designed to fit your GM engine. These performance 8mm spark plug wires exhibit only 600 ohms per foot of resistance, with high noise suppression capabilities. Features include black wires with white Chevrolet insignia and black boots. Manufactured with double-wall silicone construction.

- Kits include a 10" coil wire for engines such as Ram Jet 350 and ZZ572 engines, which have remote-coil HEI, plus 4 wire separators and HEI terminals and boots for the distributor cap.
- Custom-fit set designed to be used with Wire Loom Kit P/N 12496806



12496806

Wire Loom Kit

- Stainless-steel supports with the Bowtie logo laser-cut in each of the 6 supports
- Use with spark plug wire set P/N 19433385



Starters: Additional Required Components

Part Number	Bolts (Quantity)	Engine Application
19433448	14097279 (1), 14097278 (1)	Small-Block (except LT or LS Engines)
10465143	14097279 (1), 14097278 (1)	Small-Block (except LT or LS Engines) and 19433031, 19433042
12363128	14097278 (1)	Small-Block (except LT or LS Engines)
19302919	12338064 (2)	Big-Block and 12499121, 19433162, 12371171

CARBURETORS AND THROTTLE BODIES

Chevrolet Performance has the right carburetor or throttle body to complete your new crate engine or give life to your rebuilt engine. All carburetors feature show-car-quality polished finish and include all necessary bolts and gaskets.



Carburetor – Holley 670-cfm

Part Number	Description	Technical Notes
19420449	Carburetor – Holley 650-cfm (not shown)	Holley 4150-style 650-cfm 4-bbl carburetor; Mechanical secondaries; Manual choke; 4-corner idle adjustment; Power valve blowout protection; Replaces Holley 4160 600-cfm carburetor P/N 19420450
19420450	Carburetor – Holley 670-cfm	Holley 4150-style 670-cfm 4-bbl carburetor; Dual-feed fuel bowls with center-hung floats; Vacuum secondaries; Electric choke; Power valve blowout protection; Quick-change adjustable vacuum secondary
19420445	Carburetor – Holley 770-cfm (not shown)	Holley 4150-style 770-cfm 4-bbl carburetor; Dual-feed fuel bowls with center-hung floats; Vacuum secondaries; Automatic electric choke; Quick-change adjustable vacuum secondary; Recommended for Small-Block and Big-Block engines; Replaces Holley 4160 750-cfm carburetor P/N 19420445
17096144	Throttle Body – Ram Jet 350 (not shown)	Used on the Ram Jet 350 crate engine; Use throttle body gasket P/N 12570168 and bolt P/N 11588714 for installation; Single 75mm blades

AIR CLEANERS



Air Cleaner – Chevrolet Logo Classic Design



Air Cleaner – Chevrolet Logo High-Performance Design



Air Cleaner – Low-Profile Bowtie Chevrolet Design



Air Cleaner – Ram Jet 350

Part Number	Description	Technical Notes
12342071	Air Cleaner – Chevrolet Logo Classic Design	14" round classic-style air cleaner; Has chrome lid with embossed Chevrolet name and Bowtie attaching nut; Fits most 4-bbl and 2-bbl carburetors; Does not fit Dominator-style carburetors
12342080	Air Cleaner – Chevrolet Logo High-Performance Design	14" round high-performance style air cleaner; Has chrome lid with embossed Chevrolet name; Fits most 4-bbl and 2-bbl carburetors; Does not fit Dominator-style carburetors NOTE: Check clearance between hood and top of air cleaner. Minimum clearance is 3.750" from top of carburetor gasket area to underside of hood.
19351805	Air Cleaner – Low-Profile Bowtie Chevrolet Design	Cast-aluminum flat lid with hidden carb stud mount; Flat black with machined logo; 14" round high-performance style; Fits most 4-bbl and 2-bbl carburetors; Matches black slant-edge valve cover P/N 19351534
12498951	Air Cleaner – Ram Jet 350	Designed for use with throttle body on Ram Jet 350 crate engine; Can be used on other applications

FUEL PUMPS AND COMPONENTS



Fuel Pump – High Capacity, Small-Block



Fuel Filter



Small-Block Fuel Pump Block-Off Plate



Electric Fuel Pump



Electric Fuel Pump – High-Output

Part Number	Description	Technical Notes
19419400	Fuel Pump – High Capacity, Small-Block	For use on carbureted engines; Pump has 7 psi shutoff pressure and free-flow rating of 30 gph; Lower housing can be rotated to reposition inlet and outlet ports
854619	Fuel Filter	High-capacity in-line filter; Suitable for all high-performance carbureted applications; 5/16" inlet and outlet
12341998	Small-Block Fuel Pump Block-Off Plate	Plate has stamped Bowtie logo; Gasket included

Electric Fuel Pumps

6472657	Electric Fuel Pump	For use on all carbureted engines; Flows 30–40 gph at 6–9 psi
25115899	Electric Fuel Pump – High-Output	Heavy-duty 12-volt electric rotary pump; Flows 72 gph at 6–8 psi



Parts intended for competition use only. See page 2 for details.



Performance

165



Big-Block Crate Engines

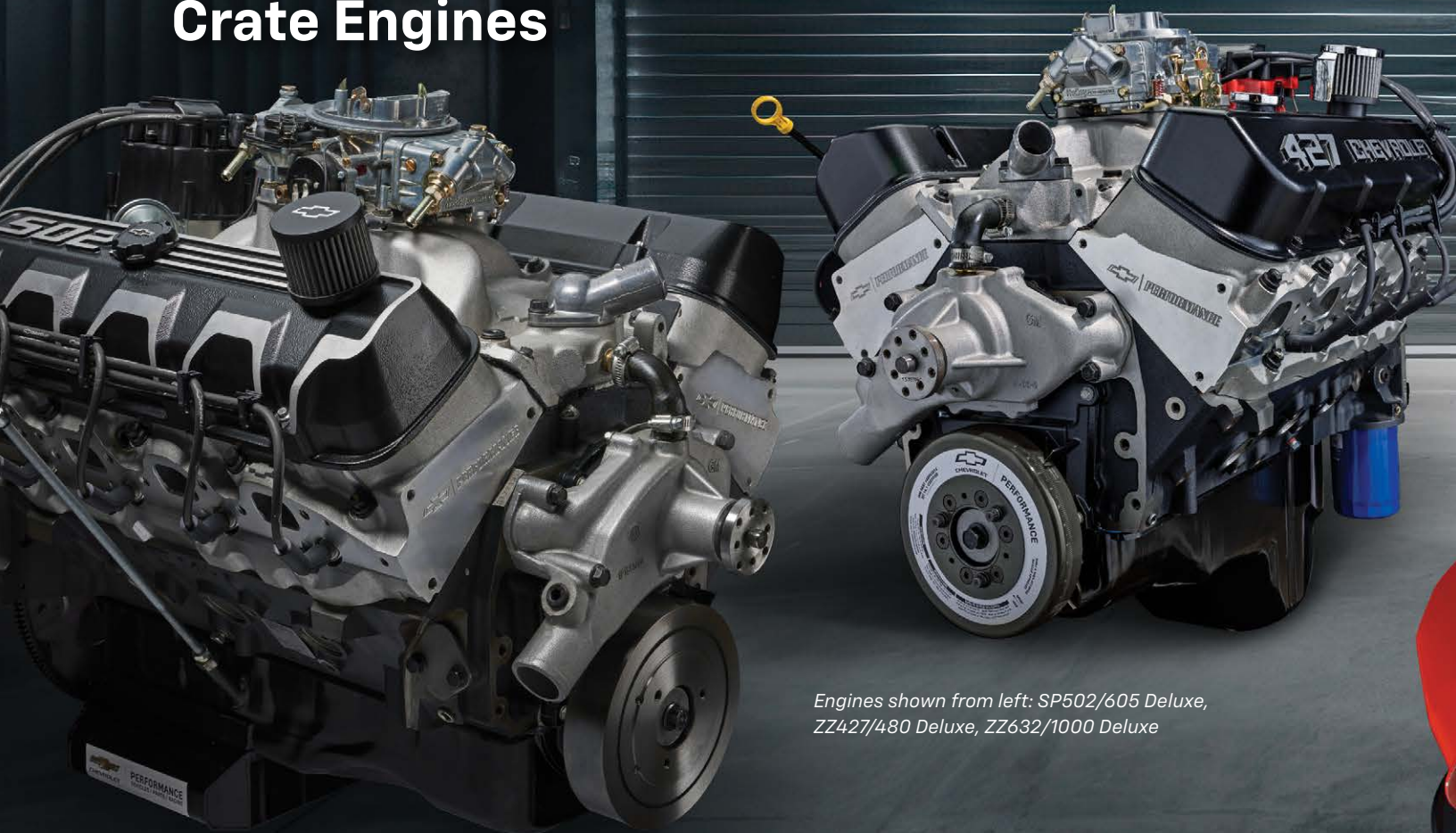

Engines shown from left: SP502/605 Deluxe, ZZ427/480 Deluxe, ZZ632/1000 Deluxe

New SP502/605 Deluxe leads lineup of big-displacement performers!

Our lineup of big-torque Big-Block crate engines offers something for almost everyone, whether you're looking for a budget-friendly performer like the 454 HO or something to support your drag-strip dominance goals like our uncompromising ZZ572/720R engine built for racing. We also offer the 605 horsepower SP502/605 Deluxe with oval port heads, high-compression pistons and a hydraulic roller camshaft. Topping off the portfolio is the ZZ632/1000 Deluxe, the biggest, baddest Big-Block crate engine ever from Chevrolet Performance, with unique spread-port heads and port fuel injection contributing to a stunning 1004 horsepower!

Check out the following pages to find the Chevrolet Performance Big-Block Engine that's right for you!

ZZ427/480 DELUXE	168	ZZ502/502 BASE	179
454 HO	170	SP502/605 DELUXE.....	180
ZZ454/440	172	ZZ572/620 DELUXE	182
HT502	174	ZZ572/620 BASE	183
502 HO	176	ZZ572/720R DELUXE	184
ZZ502/502 DELUXE.....	178	ZZ632/1000 DELUXE	186

NOTE: Engines may not come with all the parts shown in photo. See your dealer for more details.



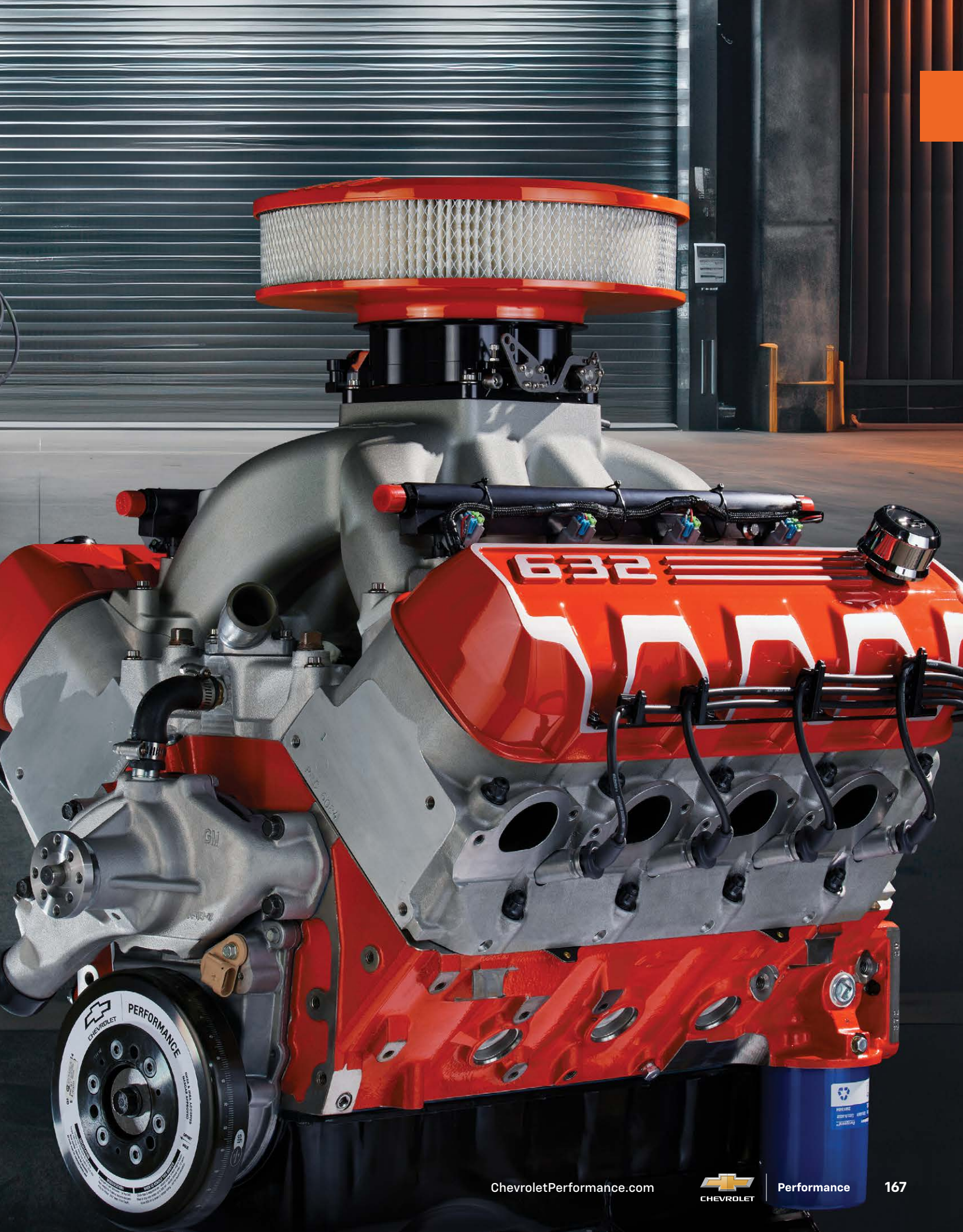

ZZ427/480 Deluxe

19331572 

480 hp

@ 6,000 rpm

490 lb.-ft.

@ 3,800 rpm

DYNO CHART

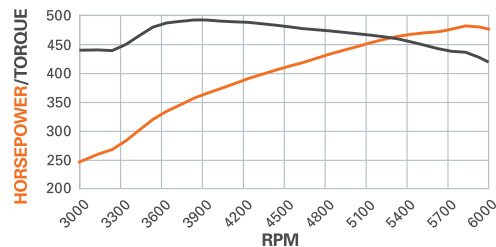

NOTE: Refer to page 6 for the complete horsepower and torque testing procedures.



The classic L88 with a modern twist

The legendary L88 was the pinnacle of Chevy's Big-Block power, and the ZZ427/480 crate engine carries that spirit with modern updates that enhance performance, making it the ultimate expression of Chevy heritage for your classic Corvette.

Like the original, our ZZ427/480 combines a sturdy iron cylinder block with lightweight aluminum cylinder heads and a single four-barrel carburetor. That raspy crate engine was rated at 430 horsepower, although the figure was generally thought to be on the conservative side. We've upgraded the camshaft from the original's mechanical flat-tappet design to a smoother hydraulic roller, which delivers great drivability characteristics and a broader rev range. A 10.1:1 compression ratio means it will perform great on pump gas.

INSTALLATION NOTES

- Due to crate fitment, the carburetor is shipped in a separate box and needs to be installed by an engine installer
- Requires addition of starter and fuel pump (not included)
- Clutch linkage bosses are drilled and tapped. When using cast-iron exhaust manifolds, lower head bolts may need to be replaced with bolts with shorter heads, for clearance
- Comes with an internally balanced 14" automatic transmission flexplate; See page 202 for a listing of manual transmission flywheels offered by Chevrolet Performance; Requires flywheel designed for internally balanced engines
- Not intended for marine applications

TECH SPECS

Part Number:	19331572
Engine Type:	Chevy Big-Block V-8
Displacement (cu in):	427
Bore x Stroke (in):	4.250 x 3.750
Block (P/N 19170538):	Cast iron with 4-bolt main caps
Crankshaft (P/N 19171620):	Forged steel
Connecting Rods (P/N 19211226):	Forged steel
Pistons (P/N 19171618):	Forged aluminum
Intake Manifold (P/N 12363406):	Dual plane
Carburetor (P/N 19420445):	770-cfm
Camshaft Type (P/N 12366543):	Hydraulic roller
Valve Lift (in):	.527 intake / .544 exhaust
Camshaft Duration (@.050 in):	224° intake / 234° exhaust
Cylinder Heads (P/N 19331423):	Aluminum oval port, 110cc chambers
Valve Size (in):	2.190 intake / 1.880 exhaust
Compression Ratio:	10.1:1
Rocker Arms (P/N 19210726):	Aluminum roller-style
Rocker Arm Ratio:	1.7:1
Water Pump (P/N 19168602):	Aluminum short-style
Recommended Fuel:	Premium pump
Distributor:	Billet HEI type
Spark Plugs and Wires:	Included
Ignition Timing:	36° Total @ 4,000 rpm
Maximum Recommended rpm:	6,400
Balanced:	Internal
Flexplate (P/N 12561217):	14"

NOTE: Distributor with melonized steel gear **MUST** be used with long-blocks and partial engines with steel camshafts, or engine damage will occur.

Mobil 1 is the recommended engine oil for all Chevrolet Performance Engines



Chevrolet Performance Crate Engines include a 24-month or 50,000-mile/80,000-kilometer limited warranty, whichever comes first. See your GM dealer for details.



Chevrolet Performance **does not** utilize any used or remanufactured parts in this crate engine, except for the starter, alternator and power steering pump.



This part is intended for competition use only. See page 2 for complete details.

CONNECT & CRUISE CONFIGURATIONS

Chevrolet Performance's Connect & Cruise systems match our crate engines with transmissions for factory-engineered performance combinations—including supporting controllers and installation kit recommendations—that take the guesswork out of your project. See page 32 for more details.

ZZ427/480 with 4L70-E Automatic 

Engine:	19331572	Torque Converter:	19299801
Transmission:	19368613	Controller:	19332775
Install Kit:	19433118		

ZZ427/480 with Super Magnum Six-Speed Manual 

Engine:	19331572	Install Kit:	19329902
Transmission:	19352208		



TRANSMISSION OPTIONS

See pages 20–31 for additional options.



19368613
SuperMatic™ 4L70-E Four-Speed Automatic (remanufactured)

Based on the 4L60-E, the 4L70-E electronically controlled four-speed automatic is rated for up to 495 lb.-ft. of torque. For strength, it features five-pinion gearsets, heat-treated stator shaft splines, an induction-hardened turbine shaft and more, including a unique valve body calibration. Does not include converter. See page 24 for more details.



19300175
SuperMatic™ 4L85-E Four-Speed Automatic

Based on the 4L80-E, the 4L85-E electronically controlled four-speed automatic is rated for up to 690 lb.-ft. of torque. For strength, it features five-pinion gearsets and additional clutch plates, while a unique valve body delivers firmer shifts than production 4L85 transmissions. Does not include converter. See page 25 for more details.



19352208
Super Magnum Six-Speed Manual

This high-torque capacity TREMEC six-speed manual is designed for custom, retro-fit installations with Chevrolet Performance crate engines. It has a 700-lb.-ft. torque capacity and features a 40-tooth reluctor ring. See page 29 for more details.

ENGINE-RELATED PARTS & ACCESSORIES



19332775
Transmission Controller
page 28



19420956
Transmission Installation Kit
page 25



19299805
Torque Converter
page 22



19433448 
High-Torque Mini Starter
page 207



12342071 
Air Cleaner
page 208



Parts intended for competition use only. See page 2 for details.



454 HO

19433409 

438 hp

@ 5,300 rpm

500 lb.-ft.

@ 3,500 rpm

DYNO CHART

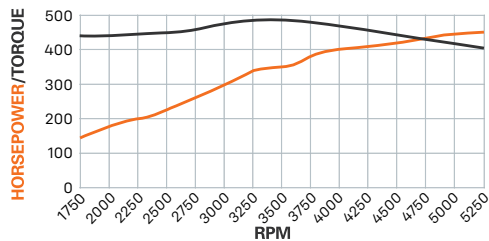

NOTE: Refer to page 6 for the complete horsepower and torque testing procedures.



Our budget Big-Block performer!

Chevrolet Performance's 454 HO crate engine offers strong Big-Block torque—500 lb.-ft.—to fit almost any builder's budget. The foundation is a brand-new, updated cylinder block, which incorporates many strength and performance design enhancements to make it a smart and economical alternative to rebuilding.

We also added an all-forged reciprocating assembly for greater durability, a roller camshaft that optimizes performance and a set of deep-breathing rectangular-port iron cylinder heads. The 454 HO is delivered with a water pump, balancer, 14-inch flexplate and aluminum intake manifold. Add a carburetor, ignition system and starter and your budget Big-Block will be ready to roar. All of the necessary parts are available from Chevrolet Performance.

INSTALLATION NOTES

- Requires addition of carburetor, starter, fuel pump, distributor and ignition system (not included)
- Clutch linkage bosses are now drilled and tapped. When using cast-iron exhaust manifolds, lower head bolts may need to be replaced with bolts with shorter heads, for clearance
- Comes with an externally balanced 14" automatic transmission flexplate; use flywheel P/N 14096987 and 11" clutch assembly for manual transmission applications
- Not intended for marine applications

TECH SPECS

Part Number:	19433409
Engine Type:	Chevy Big-Block V-8
Displacement (cu in):	454
Bore x Stroke (in):	4.250 x 4.000
Block (P/N 19170538):	Cast iron with 4-bolt main caps
Crankshaft (P/N 14096983):	Forged steel
Connecting Rods (P/N 19170198):	Forged steel
Pistons (P/N 19432034):	Forged aluminum
Intake Manifold (P/N 19131359):	Dual plane
Camshaft Type (P/N 24502611):	Hydraulic roller
Valve Lift (in):	.510 intake / .540 exhaust
Camshaft Duration (@.050 in):	211° intake / 230° exhaust
Cylinder Heads (P/N 12562920):	Iron rectangular port; 118cc chambers
Valve Size (in):	2.190 intake / 1.880 exhaust
Compression Ratio:	8.75:1
Rocker Arms (P/N 19260993):	Stamped steel
Rocker Arm Ratio:	1.7:1
Water Pump (P/N 12708488):	Cast-iron, long-style
Recommended Fuel:	Premium pump
Ignition Timing:	36° Total @ 4,000 rpm
Maximum Recommended rpm:	5,500
Balanced:	External
Flexplate (P/N 10185034):	14"

NOTE: Distributor with melonized steel gear **MUST** be used with long-blocks and partial engines with steel camshafts, or engine damage will occur.

Mobil 1 is the recommended engine oil for all Chevrolet Performance Engines



Chevrolet Performance Crate Engines include a 24-month or 50,000-mile/80,000-kilometer limited warranty, whichever comes first. See your GM dealer for details.



Chevrolet Performance does not utilize any used or remanufactured parts in this crate engine, except for the starter, alternator and power steering pump.



This part is intended for competition use only. See page 2 for complete details.

ADDITIONAL BUILD OPTIONS

19433375 **454 Partial Engine**

For those who want the strength and convenience of our 454 bottom end, including its updated block design, but want to add your own heads and induction system, start with our 454 Partial Engine assembly. It's a strong foundation for Big-Block performance.



TRANSMISSION OPTIONS

See pages 20–31 for additional options.



19368615

SuperMatic™ 4L75-E Four-Speed Automatic (remanufactured)

Based on the 4L65-E/4L70-E, the 4L75-E electronically controlled four-speed automatic is rated for up to 650 lb.-ft. of torque. For strength, it features five-pinion gearsets, heat-treated stator shaft splines, an induction-hardened turbine shaft and more, including a unique valve body calibration. Does not include converter. See page 24 for more details.



19300175

SuperMatic™ 4L85-E Four-Speed Automatic

Based on the 4L80-E, the 4L85-E electronically controlled four-speed automatic is rated for up to 690 lb.-ft. of torque. For strength, it features five-pinion gearsets and additional clutch plates, while a unique valve body delivers firmer shifts than production 4L85 transmissions. Does not include converter. See page 25 for more details.



19352208

Super Magnum Six-Speed Manual

This high-torque capacity TREMEC six-speed manual is designed for custom, retro-fit installations with Chevrolet Performance crate engines. It has a 700-lb.-ft. torque capacity and features a 40-tooth reluctor ring. See page 29 for more details.

ENGINE-RELATED PARTS & ACCESSORIES

**19299805 Torque Converter**

page 22

**19420445  Carburetor – Holley 770-cfm**

page 207

**19302919  Lightweight Starter**

page 207

**19420956 Transmission Installation Kit**

page 25

**19432312  HEI Distributor**

page 204

**19332780 Transmission Controller**

page 28

**19329634 Big-Block Clutch Kit**

page 30

**19329025 Big-Block Bell Housing Kit**

page 29



Parts intended for competition use only. See page 2 for details.



Performance

171

ZZ454/440

19433410 

469 hp

@ 5,500 rpm

519 lb.-ft.

@ 3,700 rpm

DYNO CHART

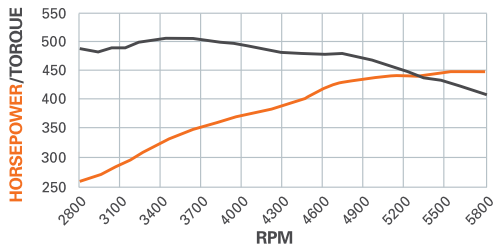

NOTE: Refer to page 6 for the complete horsepower and torque testing procedures.



Aluminum oval-port heads add power!

Our engineers took the tough 454 HO and matched it with a set of higher-flow, oval-port aluminum cylinder heads to pick up an additional 30 horses and push the torque to a strong 519 lb.-ft. The heads are filled with 2.19/1.88-inch valves that process the airflow through this big-power Big-Block and save weight over iron heads.

Along with the aluminum heads, the ZZ454/440 also features our latest-generation block casting with four-bolt main caps, which is filled with an all-forged rotating assembly for exceptional strength and durability. There's also a high-lift hydraulic roller camshaft for excellent drivability and a broad performance range. The crate engine assembly includes the water pump, balancer, aluminum intake manifold and a 14-inch flexplate. Add the carburetor, starter, ignition system and other accessories to get this big-power Big-Block running.

INSTALLATION NOTES

- Requires addition of carburetor, starter, fuel pump, distributor and ignition system (not included)
- Clutch linkage bosses are now drilled and tapped. When using cast-iron exhaust manifolds, lower head bolts may need to be replaced with bolts with shorter heads, for clearance
- Comes with an externally balanced 14" automatic transmission flexplate; use flywheel P/N 14096987 and 11" clutch assembly for manual transmission applications
- Not intended for marine applications

Mobil 1 is the recommended engine oil for all Chevrolet Performance Engines

TECH SPECS

Part Number:	19433410
Engine Type:	Chevy Big-Block V-8
Displacement (cu in):	454
Bore x Stroke (in):	4.250 x 4.000
Block (P/N 19170538):	Cast iron with 4-bolt main caps
Crankshaft (P/N 14096983):	Forged steel
Connecting Rods (P/N 19170198):	Forged steel
Pistons (P/N 19433024):	Forged aluminum
Intake Manifold (P/N 12363406):	Dual plane
Camshaft Type (P/N 24502611):	Hydraulic roller
Valve Lift (in):	.510 intake / .540 exhaust
Camshaft Duration (@.050 in):	211° intake / 230° exhaust
Cylinder Heads (P/N 19418909):	Aluminum oval port; 110cc chambers
Valve Size (in):	2.190 intake / 1.880 exhaust
Compression Ratio:	9.6:1
Rocker Arms (P/N 12675724):	Stamped steel
Rocker Arm Ratio:	1.7:1
Water Pump (P/N 12708488):	Cast-iron, long-style
Recommended Fuel:	Premium pump
Ignition Timing:	36° Total @ 4,000 rpm
Maximum Recommended rpm:	5,500
Balanced:	External
Flexplate (P/N 10185034):	14"

NOTE: Distributor with melonized steel gear **MUST** be used with long-blocks and partial engines with steel camshafts, or engine damage will occur.



Chevrolet Performance Crate Engines include a 24-month or 50,000-mile/80,000-kilometer limited warranty, whichever comes first. See your GM dealer for details.



Chevrolet Performance does not utilize any used or remanufactured parts in this crate engine, except for the starter, alternator and power steering pump.



This part is intended for competition use only. See page 2 for complete details.

ADDITIONAL BUILD OPTIONS

19433375 **454 Partial Engine**

For those who want the strength and convenience of our 454 bottom end, including its updated block design, but want to add your own heads and induction system, start with our 454 Partial Engine assembly. It's a strong foundation for Big-Block performance.



TRANSMISSION OPTIONS

19300175

SuperMatic™ 4L85-E Four-Speed Automatic

Based on the 4L80-E, the 4L85-E electronically controlled four-speed automatic is rated for up to 690 lb.-ft. of torque. For strength, it features five-pinion gearsets and additional clutch plates, while a unique valve body delivers firmer shifts than production 4L85 transmissions. Does not include converter. Use with electronic controller P/N 19302410 for LS/LSX-based fuel-injected engines. See page 25 for more details.



19352208

Super Magnum Six-Speed Manual

This high-torque capacity TREMEC six-speed manual is designed for custom, retro-fit installations with Chevrolet Performance crate engines. It has a 700-lb.-ft. torque capacity and features a 40-tooth reluctor ring. See page 29 for more details.



ENGINE-RELATED PARTS & ACCESSORIES

19420956
Transmission
Installation Kit

page 25

19332780
Transmission
Controller

page 28

19299805
Torque Converter

page 22

19420445 
Carburetor – Holley 770-cfm

page 207

19302919 
Lightweight Starter

page 207



Parts intended for competition use only.
See page 2 for details.



Performance

173

HT502

19433156 

406 hp

@ 4,200 rpm

541 lb.-ft.

@ 3,200 rpm

DYNO CHART

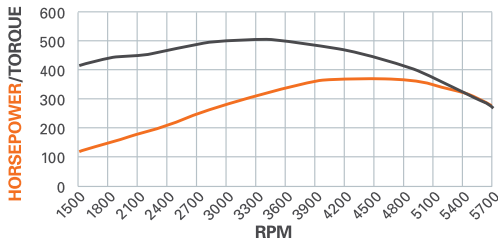

NOTE: Refer to page 6 for the complete horsepower and torque testing procedures.



A powerful alternative to rebuilding

When it comes to repowering your trusted Big-Block-powered pulling truck, don't bother with the time it takes for rebuilding, when Chevrolet Performance's HT502 offers an affordable, durable and powerful alternative.

It is built with a brand-new, latest-generation cylinder block with four-bolt main caps and features an all-forged rotating assembly for strength. A mild 8.75:1 compression ratio also makes it suitable for pump gas at all elevations. The assembly comes with the heads and a balancer installed. An induction system, ignition, starter, water pump and other accessories are required to finish the engine. All of the necessary components are available from Chevrolet Performance.

INSTALLATION NOTES

- Requires the addition of carburetor, intake manifold, water pump, fuel pump, starter, distributor and ignition system (not included)
- Clutch linkage bosses are now drilled and tapped. When using cast-iron exhaust manifolds, lower head bolts may need to be replaced with bolts with shorter heads, for clearance
- 502 engines now have a mechanical fuel pump boss! (**NOTE:** There is NO fuel pump lobe behind the boss.)
- Comes with an externally balanced 14" automatic transmission flexplate; Use externally balanced flywheel P/N 14096987 and 11" clutch assembly for manual transmission applications
- Not intended for marine applications

Mobil 1 is the recommended engine oil for all Chevrolet Performance Engines

TECH SPECS

Part Number:	19433156
Engine Type:	Chevy Big-Block V-8
Displacement (cu in):	502
Bore x Stroke (in):	4.470 x 4.00
Block (P/N 19170540):	Cast iron with 4-bolt main caps
Crankshaft (P/N 10183723):	Forged steel
Connecting Rods (P/N 19170198):	Forged steel, shot peened
Pistons (P/N 12533507):	Forged aluminum
Camshaft Type (P/N 12552296):	Hydraulic roller
Valve Lift (in):	.480 intake / .483 exhaust
Camshaft Duration (@.050 in):	204° intake / 208° exhaust
Cylinder Heads (P/N 12562917):	Iron oval port; 118cc chambers
Valve Size (in):	2.07 intake / 1.73 exhaust
Compression Ratio:	8.75:1
Rocker Arms (P/N 19260993):	Stamped steel
Rocker Arm Ratio:	1.7:1
Recommended Fuel:	Regular pump
Ignition Timing:	34° Total @ 4,000 rpm
Maximum Recommended rpm:	5,500
Balanced:	External
Flexplate (P/N 10185034):	14"

NOTE: Distributor with melonized steel gear **MUST** be used with long-blocks and partial engines with steel camshafts, or engine damage will occur.



Chevrolet Performance Crate Engines include a 24-month or 50,000-mile/80,000-kilometer limited warranty, whichever comes first. See your GM dealer for details.



Chevrolet Performance **does not** utilize any used or remanufactured parts in this crate engine, except for the starter, alternator and power steering pump.



This part is intended for competition use only. See page 2 for complete details.

ADDITIONAL BUILD OPTIONS

19433158 **502 Partial Engine**

Similar to the HT502 and 502 HO engine assemblies. Includes a brand-new four-bolt block and forged rotating assembly, but delivered without the cylinder heads. Assembly includes the balancer, oil pan and timing gear set.

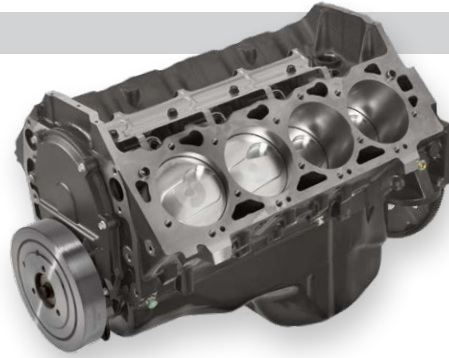

TRANSMISSION OPTIONS

19300175

SuperMatic™ 4L85-E Four-Speed Automatic

Based on the 4L80-E, the 4L85-E electronically controlled four-speed automatic is rated for up to 690 lb.-ft. of torque. For strength, it features five-pinion gearsets and additional clutch plates, while a unique valve body delivers firmer shifts than production 4L85 transmissions. Does not include converter. Use with electronic controller P/N 19302410 for LS/LSX-based fuel-injected engines. See page 25 for more details.



19352208

Super Magnum Six-Speed Manual

This high-torque capacity TREMEC six-speed manual is designed for custom, retro-fit installations with Chevrolet Performance crate engines. It has a 700-lb.-ft. torque capacity and features a 40-tooth reluctor ring. See page 29 for more details.





ENGINE-RELATED PARTS & ACCESSORIES



19299805

Torque Converter*page 22*

19420956

Transmission Installation Kit*page 25*19302919 **Lightweight Starter***page 207*19420445 **Carburetor – Holley 770-cfm***page 207*

19168602

Aluminum Water Pump – Short-Style*page 203*

19332780

Transmission Controller*page 28*

Parts intended for competition use only.
See page 2 for details.



Performance

175

502 HO

19433157 

461 hp

@ 5,100 rpm

558 lb.-ft.

@ 3,400 rpm

DYNO CHART

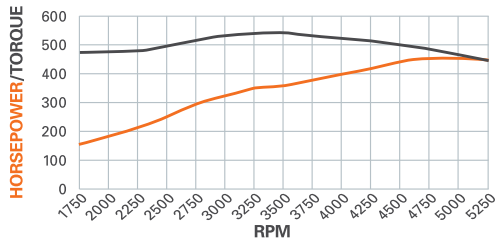

NOTE: Refer to page 6 for the complete horsepower and torque testing procedures.



Affordable Big-Block performance

Whether you use it for your drag car or competition pulling truck, the value-driven 502 HO crate engine offers affordable performance. It's rated at 461 horsepower and 558 lb.-ft. of torque, for pulling power that exceeds anything ever offered from Chevrolet's production Big-Block engines. It's real power that only comes from a Big-Block!

To support all that torque, we built the 502 HO with a brand-new, latest-generation block casting with four-bolt main cap. We complement that with an all-forged rotating assembly for exceptional strength and durability, while a hydraulic roller camshaft is used for excellent drivability and a broad performance range. Our crate engine assembly includes an aluminum, dual-plane intake manifold, a water pump, 14-inch flexplate, balancer and more. You add the carburetor, starter and ignition system—all available from Chevrolet Performance.

INSTALLATION NOTES

- Requires addition of carburetor, fuel pump, starter, distributor and ignition system (not included)
- Clutch linkage bosses are now drilled and tapped. When using cast-iron exhaust manifolds, lower head bolts may need to be replaced with bolts with shorter heads, for clearance
- 502 engines now have a mechanical fuel pump boss! (**NOTE:** There is a fuel pump lobe behind the boss.)
- Comes with an externally balanced 14" automatic transmission flexplate; Use flywheel P/N 14096987 and 11" clutch assembly for manual transmission applications
- Not intended for marine applications

Mobil 1 is the recommended engine oil for all Chevrolet Performance Engines

TECH SPECS

Part Number:	19433157
Engine Type:	Chevy Big-Block V-8
Displacement (cu in):	502
Bore x Stroke (in):	4.470 x 4.000
Block (P/N 19170540):	Cast iron with 4-bolt main caps
Crankshaft (P/N 10183723):	Forged steel
Connecting Rods (P/N 19170198):	Forged steel, shot peened
Piston and Ring Kit (P/N 12533507):	Forged aluminum
Intake Manifold (P/N 19131359):	Dual plane
Camshaft Type (P/N 24502611):	Hydraulic roller
Valve Lift (in):	.510 intake / .540 exhaust
Camshaft Duration (@.050 in):	211" intake / 230" exhaust
Cylinder Heads (P/N 12562920):	Iron rectangular port; 118cc chambers
Valve Size (in):	2.190 intake / 1.880 exhaust
Compression Ratio:	8.75:1
Rocker Arms (P/N 19260993):	Stamped steel
Rocker Arm Ratio:	1.7:1
Water Pump (P/N 12708488):	Cast-iron, long-style
Recommended Fuel:	Regular pump
Ignition Timing:	32° Total @ 4,000 rpm
Maximum Recommended rpm:	5,500
Balanced:	External
Flexplate (P/N 10185034):	14"

NOTE: Distributor with melonized steel gear **MUST** be used with long-blocks and partial engines with steel camshafts, or engine damage will occur.



Chevrolet Performance Crate Engines include a 24-month or 50,000-mile/80,000-kilometer limited warranty, whichever comes first. See your GM dealer for details.



Chevrolet Performance **does not** utilize any used or remanufactured parts in this crate engine, except for the starter, alternator and power steering pump.



This part is intended for competition use only. See page 2 for complete details.

ADDITIONAL BUILD OPTIONS

19433158 **502 Partial Engine**

Similar to the HT502 and 502 HO engine assemblies. Includes a brand-new four-bolt block and forged rotating assembly, but delivered without the cylinder heads. Assembly includes the balancer, oil pan and timing gear set.

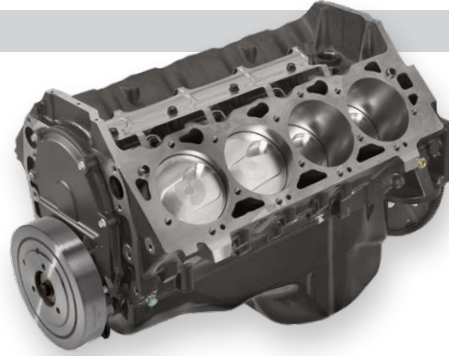

TRANSMISSION OPTIONS

19300175

SuperMatic™ 4L85-E Four-Speed Automatic

Based on the 4L80-E, the 4L85-E electronically controlled four-speed automatic is rated for up to 690 lb.-ft. of torque. For strength, it features five-pinion gearsets and additional clutch plates, while a unique valve body delivers firmer shifts than production 4L85 transmissions. Does not include converter. Use with electronic controller P/N 19302410 for LS/LSX-based fuel-injected engines. See page 25 for more details.



19352208

Super Magnum Six-Speed Manual

This high-torque capacity TREMEC six-speed manual is designed for custom, retro-fit installations with Chevrolet Performance crate engines. It has a 700-lb.-ft. torque capacity and features a 40-tooth reluctor ring. See page 29 for more details.



ENGINE-RELATED PARTS & ACCESSORIES



19332780

Transmission Controller

page 28



19420956

Transmission Installation Kit

page 25



19299805

Torque Converter

page 22

19420445 **Carburetor – Holley 770-cfm**

page 207

19302919 **Lightweight Starter**

page 207



Parts intended for competition use only.
See page 2 for details.



Performance

177

ZZ502/502 Deluxe

19433162 

508 hp

@ 5,200 rpm

580 lb.-ft.

@ 3,600 rpm

DYNO CHART

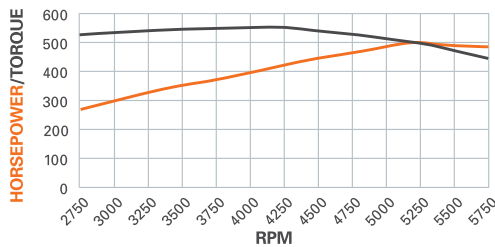

NOTE: Refer to page 6 for the complete horsepower and torque testing procedures.



Big power and torque from our most popular Big-Block!

The ZZ502/502 is one of the industry's benchmark crate engines, offering excellent value with a proven combination of performance and all-forged durability that is suitable for the strip or packed clay dirt pullers. With more than 500 horsepower and an amazing 580 lb.-ft. of torque, it will grab your attention!

Thanks to a combination of high-flow aluminum oval-port cylinder heads with 2.25/1.88-inch valves and a hydraulic roller camshaft designed to support low-rpm torque production, this torque monster tops the 500-lb.-ft. mark by approximately 2,500 rpm and holds above it until about 5,000 rpm. Our ZZ502/502 Deluxe package comes complete from the oil pan to the carburetor, including an HEI distributor, plug wires, starter, water pump, balancer and an aluminum intake topped with a Holley 870-cfm four-barrel carburetor.

INSTALLATION NOTES

- Due to crate fitment, the carburetor is shipped in a separate box and needs to be installed by an engine installer
- Clutch linkage bosses are now drilled and tapped. When using cast-iron exhaust manifolds, lower head bolts may need to be replaced with bolts with shorter heads, for clearance
- 502 engines now have a mechanical fuel pump boss! (**NOTE:** There is a fuel pump lobe behind the boss.)
- Comes with an externally balanced 14" automatic transmission flexplate; Use flywheel P/N 14096987 and 11" clutch assembly for manual applications
- Not intended for marine applications

Mobil 1 is the recommended engine oil for all Chevrolet Performance Engines

TECH SPECS

Part Number:	19433162
Engine Type:	Chevy Big-Block V-8
Displacement (cu in):	502
Bore x Stroke (in):	4.470 x 4.000
Block (P/N 19170540):	Cast iron with 4-bolt main caps
Crankshaft (P/N 10183723):	Forged steel
Connecting Rods (P/N 19170198):	Forged steel, shot peened
Pistons (P/N 12533507):	Forged aluminum
Intake Manifold (P/N 12363407):	Dual plane
Carburetor (P/N 19420447):	870-cfm
Camshaft Type (P/N 12366543):	Hydraulic roller
Valve Lift (in):	.527 intake / .544 exhaust
Camshaft Duration (@.050 in):	224° intake / 234° exhaust
Cylinder Heads (P/N 19418910):	Aluminum oval port; 110cc chambers
Valve Size (in):	2.250 intake / 1.880 exhaust; stainless steel
Compression Ratio:	9.6:1
Rocker Arms (P/N 12675724):	Stamped steel
Rocker Arm Ratio:	1.7:1
Water Pump (P/N 19168602):	Aluminum, short-style
Recommended Fuel:	Premium pump
Distributor (P/N 19432312):	HEI type
Spark Plugs and Wires:	Included
Starter (P/N 19302919):	Included
Ignition Timing:	32° Total @ 4,000 rpm
Maximum Recommended rpm:	5,800
Balanced:	External
Flexplate (P/N 10185034):	14"

NOTE: Distributor with melonized steel gear **MUST** be used with long-blocks and partial engines with steel camshafts, or engine damage will occur.



Chevrolet Performance Crate Engines include a 24-month or 50,000-mile/80,000-kilometer limited warranty, whichever comes first. See your GM dealer for details.



Chevrolet Performance **does not** utilize any used or remanufactured parts in this crate engine, except for the starter, alternator and power steering pump.



This part is intended for competition use only. See page 2 for complete details.

ADDITIONAL BUILD OPTIONS

19433160 

ZZ502/502 Base

This long-block assembly includes the cylinder heads, oil pan, front cover and flexplate. It is ready to be finished with the induction system and other accessories.



19433158 

502 Partial Engine

Similar to the HT502 and 502 HO engine assemblies. Includes a brand-new four-bolt block and forged rotating assembly, but delivered without the cylinder heads. Assembly includes the balancer, oil pan and timing gear set.

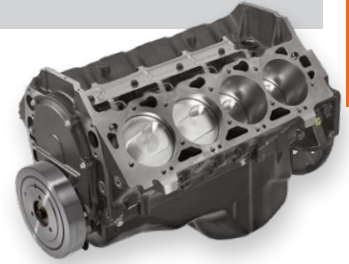

CONNECT & CRUISE CONFIGURATIONS

Chevrolet Performance's Connect & Cruise systems match our crate engines with transmissions for factory-engineered performance combinations—including supporting controllers and installation kit recommendations—that take the guesswork out of your project. See page 32 for more details.

ZZ502/502 Deluxe with 4L85-E Automatic 

Engine:	19433162	Torque Converter:	19299805
Transmission:	19300175	Controller:	19332780
Install Kit:	19420956		

ZZ502/502 Deluxe with Super Magnum Six-Speed Manual 

Engine:	19433162	Install Kit:	19329901
Transmission:	19352208		



TRANSMISSION OPTIONS

**19300175
SuperMatic™ 4L85-E
Four-Speed Automatic**

Based on the 4L80-E, the 4L85-E electronically controlled four-speed automatic is rated for up to 690 lb.-ft. of torque. For strength, it features five-pinion gearsets and additional clutch plates, while a unique valve body delivers firmer shifts than production 4L85 transmissions. See page 25 for more details.



**19352208
Super Magnum
Six-Speed Manual**

This high-torque capacity TREMEC six-speed manual is designed for custom, retro-fit installations with Chevrolet Performance crate engines. It has a 700-lb.-ft. torque capacity and features a 40-tooth reluctor ring. See page 29 for more details.



ENGINE-RELATED PARTS & ACCESSORIES



**19420956
Transmission
Installation Kit**
page 25



**19332780
Transmission
Controller**
page 28



**19329025
Big-Block Bell
Housing Kit**
page 29



**19329901
Transmission Installation
Kit – Six-Speed Super
Magnum**
page 30



Parts intended for competition use only. See page 2 for details.



SP502/605 Deluxe

19421200 

605 hp

@ 6,000 rpm

580 lb.-ft.

@ 4,000 rpm

DYNO CHART

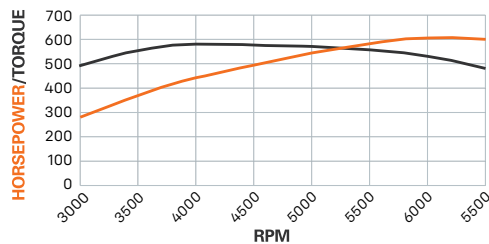

NOTE: Refer to page 6 for the complete horsepower and torque testing procedures.



One of Our most popular Big-Blocks is elevated with more power!

With the popular and proven ZZ502 as its starting point, Chevrolet Performance engineers took its capability to the next level to create the more powerful SP502/605 Deluxe, which is rated at a strong 605 hp and 580 lb.-ft. of torque. It's the sort of power for your vintage muscle car, hot rod or classic truck that comes only from the incomparable Big-Block family.

New, higher-compression pistons, a new hydraulic-roller camshaft, CNC-ported oval-port heads and more drive the SP502/605's greater output — and this all-new Big-Block crate engine is distinguished with all-new cast aluminum valve covers based on the striking, contemporary design introduced on the ZZ632. It is offered in a Deluxe kit that includes an 850-cfm carburetor and aluminum intake manifold, HEI distributor, plug wires, water pump and balancer. It also includes a new-design seven-quart oil pan.

INSTALLATION NOTES

- Due to crate fitment, the carburetor is shipped in a separate box and must be installed by the engine installer
- Clutch linkage bosses are drilled and tapped. When using cast iron exhaust manifolds, lower head bolts may need to be replaced with bolts for shorter heads, for clearance
- Block features a mechanical fuel pump boss (**NOTE:** *There is a fuel pump lobe behind the boss.*)
- Comes with an externally balanced 14" automatic transmission flexplate. Use flywheel P/N 14096987 and 11" clutch assembly for manual transmission applications
- Not intended for marine applications

Mobil 1 is the recommended engine oil for all Chevrolet Performance Engines

TECH SPECS

Part Number:	19421200
Engine Type:	Chevy Big-Block V-8
Displacement (cu in):	502
Bore x Stroke (in):	4.470 x 4.000
Block (P/N 19434240):	Cast iron with 4-bolt main caps
Crankshaft (P/N 19431552):	Forged steel
Connecting Rods (P/N 19435159):	Forged steel, shot-peened
Pistons (P/N 19434228):	Forged aluminum
Intake Manifold (P/N 12363407):	Aluminum dual-plane
Carburetor (P/N 19420446):	850-cfm four-barrel
Camshaft Type (P/N 19418730):	Hydraulic roller
Valve Lift (in):	0.649 intake / 0.650 exhaust
Camshaft Duration (@ 0.050 in):	246° intake / 257° exhaust
Cylinder Heads (P/N 19435585):	Aluminum oval port, 117cc chambers
Valve Size (in):	2.250 intake / 1.880 exhaust; stainless steel
Compression Ratio:	10.3:1
Rocker Arms (P/N 19244484):	Aluminum roller-style
Rocker Arm Ratio:	1.7:1
Water Pump (P/N 19168602):	Aluminum, short-style
Recommended Fuel:	Premium pump
Distributor (P/N 19432312):	HEI type
Spark Plugs and Wires:	Included
Ignition Timing:	34° total at 4000 RPM
Maximum Recommended RPM:	6200
Balanced:	External
Flexplate (P/N 10185034):	14"

NOTE: Distributor with melonized steel gear **MUST** be used with long-blocks and partial engines with steel camshafts, or engine damage will occur.



Chevrolet Performance Crate Engines include a 24-month or 50,000-mile/80,000-kilometer limited warranty, whichever comes first. See your GM dealer for details.



Chevrolet Performance **does not** utilize any used or remanufactured parts in this crate engine, except for the starter, alternator and power steering pump.



This part is intended for competition use only. See page 2 for complete details.

CONNECT & CRUISE CONFIGURATIONS

Chevrolet Performance's Connect & Cruise systems match our crate engines with transmissions for factory-engineered performance combinations—including supporting controllers and installation kit recommendations—that take the guesswork out of your project. See page 32 for more details.

ZZ502/605 Deluxe with 4L85-E Automatic 

Engine:	19421200	Torque Converter:	19299805
Transmission:	19300175	Trans. Controller:	19332780
Install Kit:	19420956		

ZZ502/605 Deluxe with Super Magnum Six-Speed Manual 

Engine:	19421200	Install Kit:	19329901
Transmission:	19352208		



TRANSMISSION OPTIONS

**19300175
SuperMatic™ 4L85-E Four-Speed Automatic**

Based on the 4L80-E, the 4L85-E electronically controlled four-speed automatic is rated for up to 690 lb.-ft. of torque. For strength, it features five-pinion gearsets and additional clutch plates, while a unique valve body delivers firmer shifts than production 4L85 transmissions. See page 25 for more details.



**19352208
Super Magnum Six-Speed Manual**

This high-torque capacity TREMEC six-speed manual is designed for custom, retro-fit installations with Chevrolet Performance crate engines. It has a 700-lb.-ft. torque capacity and features a 40-tooth reluctor ring. See page 29 for more details.



ENGINE-RELATED PARTS & ACCESSORIES



**19420956
Transmission
Installation Kit**
page 25



**19332780
Transmission
Controller**
page 28



**19329025
Big-Block Bell
Housing Kit**
page 29



**19329901
Transmission Installation Kit –
Six-Speed Super Magnum**
page 30



Parts intended for competition use only. See page 2 for details.



Performance

ZZ572/620 Deluxe

19331583 

621 hp

@ 5,400 rpm

645 lb.-ft.

@ 4,200 rpm

DYNO CHART

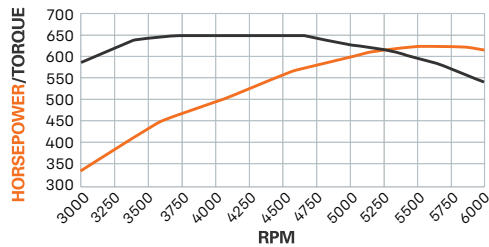

NOTE: Refer to page 6 for the complete horsepower and torque testing procedures.



Go big or go home!

Proving the adage that there's no replacement for displacement, the ZZ572/620 Deluxe is the ultimate expression of Chevrolet Performance's engineering capability, wrapped up in a soul-stirring combination of performance and attitude. We build the ZZ572 with huge 4.560-inch bores and a 4.375-inch stroke to help it deliver 621 horsepower and a stunning 645 lb.-ft. of torque.

Strength comes from a brand-new, latest-generation block casting with four-bolt main caps and an all-forged rotating assembly. High-flow aluminum rectangular-port cylinder heads and a hydraulic roller camshaft—with incredible 0.632/0.632-inch lift and 254/264-degree duration specifications—work together to optimize airflow across the rpm band. We deliver the ZZ572/620 Deluxe with an 850-cfm carburetor, HEI distributor, aluminum water pump and distinctive orange powder-coated valve covers. If your project vehicle can handle the torque, the ZZ572/620 has all the power you need!

INSTALLATION NOTES

- Due to crate fitment, the carburetor is shipped uninstalled and needs to be installed by an engine installer
- Clutch linkage boss is now drilled and tapped. When using cast-iron exhaust manifolds, lower head bolts may need to be replaced with bolts with shorter heads, for clearance
- Requires addition of starter and fuel pump (not included)
- Gen VI tall-deck block has machined mechanical fuel pump boss
- Comes with a 14" automatic transmission flexplate; Requires internally balanced flywheel for manual transmission applications
- Not intended for marine applications

Mobil 1 is the recommended engine oil for all Chevrolet Performance Engines

TECH SPECS

Part Number:	19331583
Engine Type:	Chevy Tall-Deck Big-Block V-8
Displacement (cu in):	572
Bore x Stroke (in):	4.560 x 4.375
Block (P/N 19212195):	Cast iron with 4-bolt main caps
Crankshaft (P/N 88961554):	Forged steel
Connecting Rods (P/N 88962926):	Forged steel, shot peened
Pistons (P/N 88962925):	Forged aluminum
Intake Manifold (P/N 88961161):	Single plane
Carburetor (P/N 19420446):	850-cfm
Camshaft Type (P/N 19210721):	Hydraulic roller
Valve Lift (in):	.632 intake / .632 exhaust
Camshaft Duration (@.050 in):	254° intake / 262° exhaust
Cylinder Heads (P/N 19331429):	Aluminum rectangular port, 118cc chambers
Valve Size (in):	2.250 intake / 1.88 exhaust; stainless steel
Compression Ratio:	9.6:1
Rocker Arms (P/N 19210726):	Aluminum roller style
Rocker Arm Ratio:	1.7:1
Water Pump (P/N 19168602):	Aluminum, short-style
Recommended Fuel:	Premium pump
Distributor:	HEI
Spark Plugs and Wires:	Included
Ignition Timing:	36° Total @ 4,000 rpm
Maximum Recommended rpm:	6,000
Balanced:	Internal
Flexplate (P/N 12561217):	14"

NOTE: Distributor with melonized steel gear **MUST** be used with long-blocks and partial engines with steel camshafts, or engine damage will occur.



Chevrolet Performance Crate Engines include a 24-month or 50,000-mile/80,000-kilometer limited warranty, whichever comes first. See your GM dealer for details.



Chevrolet Performance **does not** utilize any used or remanufactured parts in this crate engine, except for the starter, alternator and power steering pump.



This part is intended for competition use only. See page 2 for complete details.

ADDITIONAL BUILD OPTIONS

19331581 

ZZ572/620 Base Engine

This long-block assembly is based on the ZZ572/620 Deluxe and includes the cylinder heads, oil pan, front cover and flexplate. The induction system, water pump, distributor and additional accessories must be added to complete the engine.



CONNECT & CRUISE CONFIGURATIONS

Chevrolet Performance's Connect & Cruise systems match our crate engines with transmissions for factory-engineered performance combinations—including supporting controllers and installation kit recommendations—that take the guesswork out of your project. See page 32 for more details.

ZZ572/620 Deluxe with 4L85-E Automatic 

Engine:	19331583	Torque Converter:	19299805
Transmission:	19300175	Controller:	19332780
Install Kit:	19420956		

ZZ572/620 Deluxe with Super Magnum Six-Speed Manual 

Engine:	19331583	Install Kit:	19329902
Transmission:	19352208		



TRANSMISSION OPTIONS

19300175

SuperMatic™ 4L85-E Four-Speed Automatic

Based on the 4L80-E, the 4L85-E electronically controlled four-speed automatic is rated for up to 690 lb.-ft. of torque. For strength, it features five-pinion gearsets and additional clutch plates, while a unique valve body delivers firmer shifts than production 4L85 transmissions. See page 25 for more details.



19352208

Super Magnum Six-Speed Manual

This high-torque capacity TREMEC six-speed manual is designed for custom, retro-fit installations with Chevrolet Performance crate engines. It has a 700-lb.-ft. torque capacity and features a 40-tooth reluctor ring. See page 29 for more details.



ENGINE-RELATED PARTS & ACCESSORIES



19299805
Torque Converter
page 22



19420956
Transmission Installation Kit
page 25



19332780
Transmission Controller
page 28



19329902
Transmission Installation Kit – Six-Speed Super Magnum
page 30



19260247
Big-Block Crank Trigger Ignition Conversion Kit
page 192



Parts intended for competition use only. See page 2 for details.



Performance

ZZ572/720R Deluxe

19331585 

727 hp

@ 6,300 rpm

680 lb.-ft.

@ 4,900 rpm

DYNO CHART

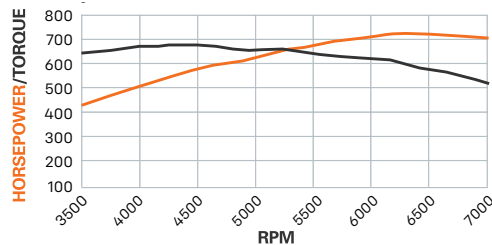

NOTE: Refer to page 6 for the complete horsepower and torque testing procedures.



Designed to dominate the drag strip!

Don't wait weeks, or even months, for a custom drag racing engine. With 727 horsepower and 680 lb.-ft. of torque, the amazing ZZ572/720R is capable of pulling your bracket racer or gasser drag car down the drag strip. We deliver it fully assembled. You simply bolt on the included Dominator-style 1150-cfm carburetor, along with a starter and fuel pump (not included) and you're ready to go!

The engine assembly is all business, starting with a brand-new, latest-generation block casting with four-bolt main caps and an all-forged rotating assembly for exceptional strength and durability. A unique mechanical roller camshaft with 0.714/0.714-inch lift and 278/282-degree duration specifications complements high-flow aluminum rectangular-port cylinder heads with massive 310cc intake passages, 118cc raised exhaust ports and 118cc combustion chambers, moving big air through the engine efficiently to make huge power.

INSTALLATION NOTES

- Due to crate fitment, the carburetor is shipped in a separate box and needs to be installed by an engine installer
- Clutch linkage boss is now drilled and tapped. When using cast-iron exhaust manifolds, lower head bolts may need to be replaced with bolts with shorter heads, for clearance
- Requires addition of starter, ignition coil, ignition box and fuel pump (not included)
- Gen VI tall-deck block has machined mechanical fuel pump boss
- Requires internally balanced flywheel for manual transmission applications
- Requires 110 octane or higher gasoline
- Not intended for marine applications

Mobil 1 is the recommended engine oil for all Chevrolet Performance Engines

TECH SPECS

Part Number:	19331585
Engine Type:	Chevy Tall-Deck Big-Block V-8
Displacement (cu in):	572
Bore x Stroke (in):	4.560 x 4.375
Block (P/N 19212195):	Cast iron with 4-bolt main caps
Crankshaft (P/N 88961554):	Forged steel
Connecting Rods (P/N 88962926):	Forged steel, shot peened
Pistons (P/N 88963227):	Forged aluminum
Intake Manifold (P/N 88962218):	Single plane
Carburetor (P/N 19170096):	1150-cfm Dominator
Camshaft Type (P/N 19210722):	Mechanical roller
Valve Lift (in):	.714 intake / .714 exhaust
Camshaft Duration (@.050 in):	278° intake / 280° exhaust
Cylinder Heads (P/N 19331430):	Aluminum rectangular port, 118cc chambers
Valve Size (in):	2.250 intake / 1.880 exhaust stainless steel
Compression Ratio:	12:1
Rocker Arms (P/N 19210726):	Aluminum roller style
Rocker Arm Ratio:	1.7:1
Water Pump (P/N 19168602):	Aluminum, short-style
Recommended Fuel:	Race gas
Distributor (P/N 10093387):	Electronic ignition
Spark Plugs and Wires:	Included
Ignition Timing:	35° Total @ 4,000 rpm
Maximum Recommended rpm:	6,750
Balanced:	Internal

NOTE: Distributor with melonized steel gear **MUST** be used with long-blocks and partial engines with steel camshafts, or engine damage will occur.



This Chevrolet Performance Racing Crate Engine is purpose-built for racing only, and has no warranty.



Chevrolet Performance does not utilize any used or remanufactured parts in this crate engine, except for the starter, alternator and power steering pump.



This part is intended for competition use only. See page 2 for complete details.

TRANSMISSION OPTIONS

19300175
SuperMatic™ 4L85-E
Four-Speed Automatic

Based on the 4L80-E, the 4L85-E electronically controlled four-speed automatic is rated for up to 690 lb.-ft. of torque. For strength, it features five-pinion gearsets and additional clutch plates, while a unique valve body delivers firmer shifts than production 4L85 transmissions. See page 25 for more details.



19352208
Super Magnum Six-Speed Manual

This high-torque capacity TREMEC six-speed manual is designed for custom, retro-fit installations with Chevrolet Performance crate engines. It has a 700-lb.-ft. torque capacity and features a 40-tooth reluctor ring. See page 29 for more details.

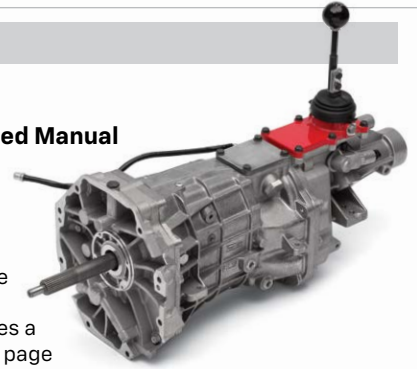

ENGINE-RELATED PARTS & ACCESSORIES



12561217
14" Flexplate
page 202



19420956
Transmission Installation Kit
page 25



19299805
Torque Converter
page 22



19302919 
Lightweight Starter
page 207



12341999
Fuel Pump Block-Off Plate
page 192



19332780
Transmission Controller
page 28



19329902
Transmission Installation Kit –
Six-Speed Super Magnum
page 30



ZZ632/1000 Deluxe

19432060 

1004 hp

@ 6,600 rpm

876 lb.-ft.

@ 5,600 rpm

DYNO CHART

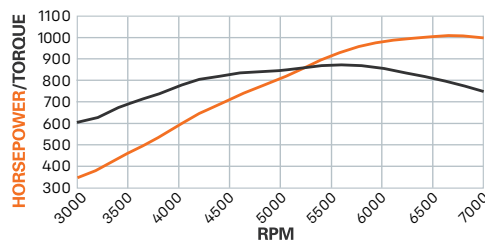

NOTE: Refer to page 6 for the complete horsepower and torque testing procedures.



Includes controller



Chevrolet's biggest, baddest Big-Block ever!

Chevrolet Performance's ZZ632 takes the legendary Big-Block to all-new thresholds of displacement performance. It's the largest Big-Block we've ever built—and with an incredible 1,004 horsepower and 876 lb.-ft. of torque on 93-octane pump gas, it's also the most powerful!

The ZZ632 starts with one of our tall-deck Sportsman Bowtie blocks as its foundation, adds an all-forged roller assembly, a hydraulic roller camshaft and all-new, high-flow spread-port cylinder heads derived from Pro Stock racing technology. An EFI induction system provides the precise fuel control to enable the crate engine's stunning output with pump gas.

Our Deluxe package comes complete from the oil pan to the throttle body, as well as a crank-trigger ignition system with coil-near-plug ignition coils mounted on a unique valley plate, plug wires, water pump, balancer and an aluminum single-plane intake manifold. The assembly also includes Chevy Orange valve covers with the "632" logo.

INSTALLATION NOTES

- Crate engine kit includes pre-programmed, self-learning control system
- Engine arrives with throttle body and harness installed.
- Requires starter, EFI-compatible high-pressure fuel pump and air cleaner compatible with 4500-series (Dominador) mounting flange
- Cylinder head exhaust port design requires custom exhaust system
- Shown with open element breathers, catch can system recommended
- Requires internally balanced flywheel for manual transmission applications
- Not intended for marine applications

Mobil 1 is the recommended engine oil for all Chevrolet Performance Engines

TECH SPECS

Part Number:	19432060
Engine Type:	Chevy Tall-Deck Big-Block V-8
Displacement (cu in):	632
Bore x Stroke (in / mm):	4.600 x 4.750
Block (P/N 19366599):	Cast iron Bowtie with 4-bolt main caps – tall deck
Crankshaft (P/N 19366600):	Forged 4340 steel
Connecting Rods (P/N 19432392):	Forged steel H-beam
Pistons (P/N 19366601):	Forged aluminum 2618 alloy
Intake Manifold (P/N 19366614):	Aluminum high-rise single-plane
Throttle Body (P/N 19366624):	4500-style
Fuel Injectors (P/N 19432057):	86-lb/hr
Camshaft Type (P/N 19432531):	Billet steel hydraulic roller
Valve Lift (in):	0.780 intake / 0.782 exhaust
Camshaft Duration (@ 0.050 in)	270° intake / 285° exhaust
Cylinder Heads (P/N 19431810):	Aluminum spread-port; 70cc chambers – RS-X design
Valve Size (in):	2.450 intake / 1.800 exhaust, titanium (5/16-in stem OD)
Ignition Type:	58X crank-triggered, coil-near-plug
Compression Ratio:	12.0:1
Rocker Arms (P/N 19421272):	Forged aluminum; roller-style
Rocker Arm Ratio:	1.8:1 (shaft-mount)
Water Pump (P/N 19168602):	Aluminum
Oil Pan (P/N 19366604):	Steel 8-quart
Recommended Fuel:	Premium pump (93 octane or higher)
Maximum Recommended RPM:	7,000 rpm
Balanced:	Internal



Chevrolet Performance Crate Engines include a 24-month or 50,000-mile/80,000-kilometer limited warranty, whichever comes first. See your GM dealer for details.



Chevrolet Performance does not utilize any used or remanufactured parts in this crate engine, except for the starter, alternator and power steering pump.



This part is intended for competition use only. See page 2 for complete details.

UNIQUE COMPONENTS FOR THE ZZ632/1000

The raised runner and parallel-port RS-X heads were inspired by the straight-flow design of Pro Stock heads that have their roots in the famed "DRCE" racing engine. They have enormous 449cc intake runners that support 481 cfm of airflow at .787-in. lift. In short, they flow huge! And they support a 7,000-rpm capability for the ZZ632.

The all-new RS-X spread-port cylinder head is available separately and will work on other Big-Block engines. More details on it, including additional specs and flow numbers, are available on page 195. The head is available assembled, CNC-machined bare and unmachined bare.

Additional ZZ632 parts are available separately:

- The unique high-rise aluminum intake manifold (requires spread-port head design on a tall-deck block). See page 206
- The unique valley cover plate with mounts for the individual ignition coils. See page 206.
- A spin-on orange cast aluminum air cleaner (P/N 19435167) that matches the valve cover design. See page 208



19431810 
**RS-X Spread-Port
 Cylinder Head Assembly**

page 195



19421272
Shaft Mount Roller Rocker Arms

page 206



19366614 
High-Rise Intake Manifold

page 206

NOTE: For tall deck block using RS-X cylinder heads



19366625
**Valley Plate and Coil
 Mounts**

NOTE: For tall deck block using RS-X cylinder heads

page 206



19433684
RS-X Rocker Bar

page 206

ENGINE RELATED PARTS & ACCESSORIES



19260247
Big-Block Crank Trigger Ignition Conversion Kit

page 192



19435167 
Air Cleaner Lid – Cast Aluminum

page 208



Parts intended for competition use only.
 See page 2 for details.



Performance

187

Big-Block

Engine Components



Big choices for big-torque engines

Oval-port or rectangular. Iron or aluminum. H-beam or I-beam. When it comes to building the Big-Block engine for your project, Chevrolet Performance has you covered with more choices than ever.

It all starts with our latest Big-Block cylinder block casting, which blends elements of earlier Mark IV and Gen VI designs, along with architectural enhancements, to optimize strength.

From there, our extensive portfolio of rotating components, cylinder heads, valvetrain parts, and air, fuel and spark components makes Chevrolet Performance a one-stop shop for building your ultimate Big-Block.

There's nothing like the torque of a genuine Big-Block and no one makes it easier to build one with factory-engineered power, strength and durability than Chevrolet Performance.

You can find these Chevrolet Performance Big-Block Engine Components on the following pages:

BLOCKS AND COMPONENTS	189	CRANKSHAFTS	201
CYLINDER HEADS	193	OIL PANS, OIL PUMPS, GASKETS AND COMPONENTS	203
VALVE COMPONENTS	196	INTAKE MANIFOLDS	205
VALVE COVERS	198	FUEL AND ELECTRICAL COMPONENTS	208
CAMSHAFTS	200		
PISTONS AND PISTON RINGS	201		

Big-Block Blocks and Components

QUICK REFERENCE CHART

Production-Based Cast-Iron Blocks

Part Number	Casting Number	Deck Height	F Pump Boss	Cyl Wall	Bore Range	Main Bolt	Main Bolt Degree	Cap Material	Crank Jnl. Dia.	Oiling	Seal Type	Max Stroke	Weight (lbs)	Max HP	Usage	Page Number
19170538	—	9.800"	Yes	Open	4.250"–4.310"	4	Straight	Cast-iron	2.750"	Wet	1 pc	4.250"	247	700	Street	189
19170540	—	9.800"	Yes	Siamese	4.470"–4.500"	4	Straight	Cast-iron	2.750"	Wet	1 pc	4.250"	269	700	Mod	189

Bowtie Cast-Iron Big-Blocks

Part Number	Casting Number	Deck Height	F Pump Boss	Cyl Wall	Bore Range	Main Bolt	Main Bolt Degree	Cap Material	Crank Jnl. Dia.	Oiling	Seal Type	Max Stroke	Weight (lbs)	Max HP	Usage	Page Number
19212191	24502504B	9.800"	Yes	Siamese	4.494"–4.600"	4	16°	Nodular	2.750"	Wet	2 pc	4.500"	258	800	Sport	190
19212192	24502504B	9.800"	Yes	Siamese	4.494"–4.600"	4	16°	Nodular	2.750"	Wet	1 pc	4.500"	258	800	Sport	190
19212194	24502506B	10.200"	Yes	Siamese	4.494"–4.600"	4	16°	Nodular	2.750"	Wet	2 pc	4.500"	263	800	Sport	190
19432546	24502506B	10.200"	Yes	Siamese	4.560"–4.600"	4	16°	Nodular	2.750"	Wet	1 pc	4.500"	263	800	Sport	190
19212196	24502504B	9.800"	Yes	Siamese	4.240"–4.600"	4	16°	Steel	2.750"	Wet	2 pc	4.500"	281	1200	Pro	192
19212197	24502506B	10.200"	Yes	Siamese	4.240"–4.600"	4	16°	Steel	2.750"	Wet	2 pc	4.500"	296	1200	Pro	192

Aluminum ZL1 Block

Part Number	Casting Number	Deck Height	F Pump Boss	Cyl Wall	Bore Range	Main Bolt	Main Bolt Degree	Cap Material	Crank Jnl. Dia.	Oiling	Seal Type	Max Stroke	Weight (lbs)	Max HP	Usage	Page Number
12370850	3946053	9.800"	Yes	Siamese	4.240"–4.300"	4	16°	Steel	2.750"	Wet	2 pc	4.375"	110	650	Pro	N/A
88958696*	88958695	9.800"	Yes	Siamese	4.250"–4.300"	4	16°	Steel	2.750"	Wet	1 pc	4.375"	110	650	Pro	190

*Used in Anniversary 427 P/N 19166392. Not available for service.

Deck Height Diagram

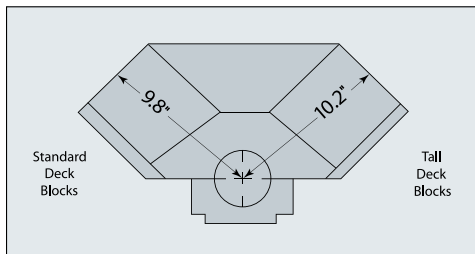

BIG-BLOCK ENGINE BLOCKS

Technical Notes:

- New design casting incorporates the best designs of Mark IV and Gen VI
- Production-type cast-iron 4-bolt block
- Machined fuel pump pad
- Water jackets for use with Mark IV or Gen VI heads
- Revised oiling to allow for bigger cam bearings/cam lift
- Can be drilled for use with 10-bolt front timing cover
- Additional clearance added for roller timing chains
- Auxiliary oil pressure line added to front of block
- Racing-style oil filter cast feature with added oil pressure port
- Additional material added around lifter bosses



502 Mark IV/Gen VI Bare Block (bottom, rear)

502 Mark IV/Gen VI Bare Block (top, rear)

Part Number	Description	Technical Notes
19170538	427/454 Bare Block (not shown)	4.250" finished bore; 4.310" max bore (non-siamese bore); Bolt boss (not machined) added near distributor hole like 8.1L; Additional boss for manual transmission clutch pivot (machined)
19170540	502 Mark IV/Gen VI Bare Block	Improved main bearing bulkheads—Bowtie block-style bulkhead; Cleared for bigger strokes; 4.470" finished bore; 4.500" max bore (siamese); Bolt boss (machined) added near distributor hole like 8.1L; Two bosses added for manual transmission clutch pivot (machined)



Parts intended for competition use only. See page 2 for details.



Performance

BOWTIE SPORTSMAN BLOCKS

Big-Blocks with big power are what you get when you select a Chevrolet Performance Bowtie Sportsman Block for your drag racing or competition application. These blocks comprise a full line of high-quality, precision-machined components based on performance-proven GM designs. The extensive lineup of blocks makes choosing the perfect block easy—and our quality and precision machining is second to none.

The blocks are CNC-machined, an automated process that guarantees precise tolerances. There are no approximations on these blocks—they're exactly right, which is critical to obtaining maximum performance. Chevrolet Performance offers more CNC-machined blocks than anyone.

The highest-quality materials are used to cast our Sportsman Bowtie blocks. They are also available as tall decks, allowing you to make more cubic inches with larger-stroke crankshafts. These blocks can easily be bored and stroked to 500 or more cubic inches. They can be fitted with one-piece or two-piece crankshaft seals for a smaller chance of oil leaks (one-piece seals) or more aftermarket component attachments (two-piece seals).

The Bowtie Sportsman blocks are available with splayed main caps, which have additional material holding the crankshaft in place. The caps are splayed at 16 degrees. Chevrolet Performance uses splayed main caps throughout the entire line of performance-built Big-Blocks.

Chevrolet Performance Bowtie Sportsman Blocks are ideal for drag racers, where the goal is 800 horsepower and long-lasting reliability.

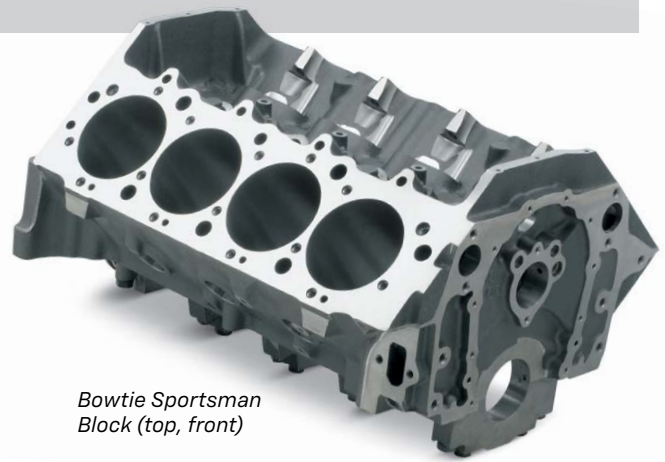

Bowtie Sportsman Block (top, front)

Bowtie Sportsman Block Technical Notes:

- Available in short deck (9.800") or tall deck (10.200") configurations
- Blocks have clearance for 4.500" stroke crankshafts
- Fully CNC machined
- Siamese cylinder bores
- Bore finishes are ready to hone to size
- Machined for mechanical fuel pump
- Machined for hydraulic roller and flat tappets
- Nodular iron 4-bolt main caps splayed 16° on the 3 center mains
- Priority main oiling system
- Blocks with a 1-piece rear main seal use the 6-bolt, Gen VI-style front cover (P/N 10230954) and Gen VI-style oil pan
- Blocks with a 2-piece rear main seal use the 10-bolt, Mark IV-style front cover and Mark IV-style oil pan

See chart on page 189 for complete specifications.



Bowtie Sportsman Block (top, rear)



2-Piece Rear Main Seal



Tall Deck Bowtie Sportsman Bare Block (top, front)





Tall Deck Bowtie Sportsman Bare Block (bottom, rear)





1-Piece Rear Main Seal

Standard Deck Sportsman Blocks

Part Number	Description	Technical Notes
88958696 	Standard Deck Bowtie AL Sportsman Block	1-piece rear main seal; CNC-machined cast-Aluminum 4-bolt block; 4.250" finished bore; 4.300" max bore; Tested to 650 horsepower; Block was used in Anniversary 427
19212192 	Standard Deck Bowtie Sportsman Block	1-piece rear main seal; CNC-machined cast-iron 4-bolt block; 4.494" finished bore; 4.600" max bore; Tested to 800 horsepower!
19212191 	Standard Deck Bowtie Sportsman Block	2-piece rear main seal; CNC-machined cast-iron 4-bolt block; 4.494" finished bore; 4.600" max bore; Tested to 800 horsepower!

Tall Deck Sportsman Blocks

Part Number	Description	Technical Notes
19212194 	Tall Deck Bowtie Sportsman Bare Block	2-piece rear main seal; CNC-machined cast-iron 4-bolt block; 4.494" finished bore; 4.600" max bore; Tested to 800 horsepower!
19432546 	Tall Deck 572 Bowtie Sportsman Bare Block	1-piece rear main seal; Uses Gen V/VI front cover and oil pan mounting; CNC-machined cast-iron 4-bolt block; 4.560" fully honed bore; 4.600" max bore; Powder-coated Chevy orange; 5 windage tray bolts installed; Tested to 800 horsepower; This is the block used for our 572 engines

CAST-IRON BOWTIE RACE BLOCKS

If you're looking to build a drag racing engine capable of producing 1,200 horses or more, a Chevrolet Performance cast-iron Bowtie Race Block is your starting point. It is designed for engine builders who want to custom-machine their blocks for specific racing applications. Toward that end, these premium castings have thick deck surfaces, improved oiling, improved coolant flow and splayed 4-bolt steel bearing caps. Everything is secured with premium fasteners. The combination of a Chevrolet Performance cast-iron Bowtie Race Block and your unique engine-building skills will put you down the track ahead of the competition.

See chart on page 189 for complete specifications.

Cast-iron Bowtie Race Block Technical Notes:

- Fully CNC machined
- Blocks are available in short deck (9.800") or tall deck (10.200")
- A sonic bore check data sheet is provided with each block
- Siamese cylinder bores
- Improved cooling around number-1 cylinder
- Accepts Mark IV or Gen V, VI cylinder heads
- Use Gen V head gaskets with Mark IV and Gen V cylinder heads
- Use Gen VI head gaskets with Gen VI cylinder heads
- Requires Mark IV design 2-piece rear main seal oil pans
- Requires Mark IV design crankshafts
- Blind-tapped head bolt holes; extra inner head bolt bosses provided
- Can use Mark IV and Gen V, VI camshafts, timing sets, lifters and timing cover (aftermarket belt-drive timing covers may require clearancing)
- 4-bolt SAE 8620 steel main caps splayed 16° on the 3 center mains
- Priority main oiling wet-sump system
- Provisions for dry-sump oil line provided
- Honed camshaft and crankshaft bores
- .842" lifter bores (maximum 1.06") may be relocated
- Distributor gear clearance at bottom of number-8 cylinder bore should be checked
- Machined mechanical fuel pump pad

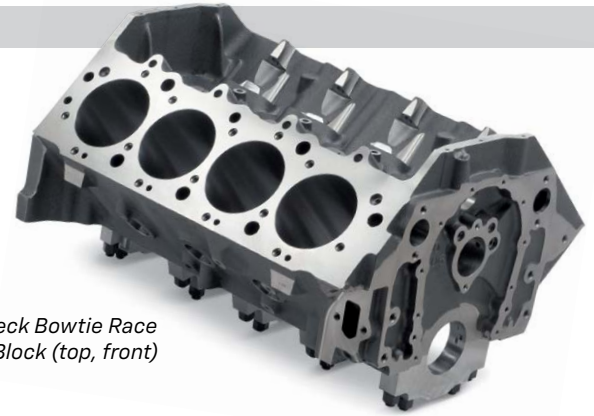

Tall Deck Bowtie Race Bare Block (top, front)

BUILDERS TIP

Valve-to-Piston Clearance Considerations

A custom engine combination should always raise the concern of valve-to-piston clearance. And while camshaft lift is commonly thought of as the primary culprit of valve/piston interference, the overlap period—when the piston nears top-dead center and the intake valve is starting to open and the exhaust valve is closing—brings the valves and piston closest together. So, don't assume the gross lift specs are all you have to worry about; duration and lobe separation are equally important, making a careful clearance inspection all the more important.



BUILDERS TIP

Shimming the Way to Correct Valve Spring Height

The correct valve spring height is important to prevent coil bind and ensure uniform spring pressure among all the valves. Don't assume the installed height (with the valve closed) is correct out of the box. Each spring's height should be carefully measured and recorded. Shims—typically sold in 0.015" heights—can be used to bring the springs to the manufacturer's specifications. The important thing about installing them is to be sure that they go beneath the spring seat. Don't simply slip them on over the top of the spring seat. With 16 valve springs to measure, it's a long, tedious process, but an important one for performance and engine longevity.

BUILDERS TIP

Thrust Bearing Alignment

On Small-Block and Big-Block engines, the thrust bearing alignment on the important #5 bearing is performed by installing only the #5 main cap and tightening its fasteners. With cap in place, the crankshaft is tapped forward or backward with a rubber mallet. When this is done, crankshaft endplay can be measured. For Small-Blocks, you're looking for between 0.005- and 0.007-inch; for Big-Blocks, the spec is 0.0065 to 0.0075-inch.



BIG-BLOCK COMPONENTS

Cast-iron Bowtie Race Blocks continued



Tall Deck Bowtie Race Bare Block (Nodular 4-Bolt Splayed Caps)



Tall Deck Bowtie Race Bare Block (top, rear)

Part Number	Description	Technical Notes
19212196	Standard Deck Bowtie Race Bare Block (not shown)	CNC-machined cast-iron 4-bolt block; 4.240" finished bore; 4.600" max bore (.250" min. wall thickness); Standard deck height (9.800"); Lifter bosses are .300" taller than standard blocks; Tested to 1,200 horsepower!
19212197	Tall Deck Bowtie Race Bare Block	CNC-machined cast-iron 4-bolt block; 4.240" finished bore; 4.600" max bore (.250 min. wall thickness); Tall deck height (10.200"); Lifter bosses are .300" taller than standard blocks; Tested to 1,200 horsepower!

CYLINDER BLOCK COMPONENTS

O-Ring Seal



Inner Main Cap Bolt (Gen V and Gen VI)



Main Bearings – 572 Engine

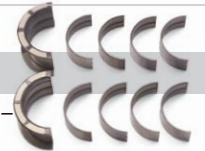

Part Number	Description	Technical Notes
6264902	O-Ring Seal (sold individually)	Use under the rear main bearing cap on all 1991-and-newer Gen V and Gen VI 454 and 502 engines
10106461	Inner Main Cap Bolt – Gen V and Gen VI	Used with Gen V and Gen VI (1991-and-newer) Big-Blocks with 4-bolt mains; Sold individually, order 10 per engine
88962212	Main Bearings – 572 Engine	Complete main bearing kit for 572 block with standard-size mains
3902885	Windage Tray Stud (not shown)	Used for mounting splash shield P/N 3967854
10224104	Windage Tray Stud – Gen V 454 and 502 (not shown)	Used with Gen V 454 and 502 engines

FRONT COVERS, PLUGS AND BLOCK-OFF PLATES

Timing Chain Cover – Gen V and Gen VI



Big-Block Fuel Pump Block-Off Plate



Big-Block Crank Trigger Ignition Conversion Kit



Part Number	Description	Technical Notes
10230954	Timing Chain Cover – Gen V and VI	Aluminum cover with timing indicator fits all 1996-and-newer Gen V and Gen VI engines; Used on all Chevrolet Performance Big-Block crate engines
11609914	Front Oil Galley Plug (not shown)	Fits front oil galley (cam tunnel) holes; .030" oil squirter hole for cooling and lubricating the timing chain
12341999	Big-Block Fuel Pump Block-Off Plate	Plate has stamped Bowtie logo; Gasket included
19260247	Big-Block Crank Trigger Ignition Conversion Kit	Enables the use of the latest aftermarket electronic control systems; 58x reluctor ring for installation on the front of the crankshaft timing gear; 4x camshaft gear; New design front cover with camshaft position and crankshaft position sensors; Double-row timing chain for greater durability, stability and timing accuracy; Requires aftermarket ignition controller capable of 58x signal (not included); Coil packs are not included; Comes with cover and sensor fasteners NOTE: Use with damper 19418278. NOTE: Minor machining of the cylinder block and the damper is required.

Freeze Plugs and Oil Plugs

Part Number	Description	Quantity
03999200	Plug, Camshaft Bearing Hole	1
00444776	¼ PTF Square Socket Plug	8
14090911	Plug, Water Outlet	1

Part Number	Description	Quantity
08654382	⅜-27 NPTF ⅜ Head Plug	1
12558081	Pin, Cylinder Head Locating	4
12720455	Pin, Transmission	2



Timing Covers: Additional Required Components

Part Number	Bolts (Quantity)	Seals (Quantity)	Gasket (Quantity)	Engine Application
11562458	11562458 (6)	10191640 (1)	10198910 (1)	19433410, 19433375, 19433156, 19331585, 19433157, 12568779, 19433162, 19433409, 19433158, 19433160, 19166392, 19331572

Big-Block Cylinder Heads

QUICK REFERENCE CHART

Part Number	Description	Casting Number	Material	Port Vol (cc)	Chbr (cc)	Int Vlv (in)	Exh Vlv (in)	Int Port Type	Exh Port Type	Heat Riser	Rocker Mount	Notes	Page Number
12562920	Gen V, VI BBC	12562934	Iron	325	118	2.180	1.880	Rect	Square	yes	Screw-in	Assembled 2925's	193
12562925	Gen V, VI BBC	12562934	Iron	325	118	2.180	1.880	Rect	Square	yes	Screw-in	7/16" accy holes	193
12562926	Gen V, VI BBC	12562934	Iron	325	118	2.180	1.880	Rect	Square	yes	Screw-in	3/8" accy holes	193
12562917	Gen V, VI BBC	12562932	Iron	—	118	2.070	1.720	Round	Square	yes	Screw-in	HT 502 head	N/S
19331427 (disc.)	NHRA L88	12363401	Alum	315	118	2.190	1.880	Rect	Square	no	Screw-in	Bare, NHRA legal	N/S
19418911 (disc.)	Rect alum	12363401	Alum	300	118	2.250	1.880	Rect	Square	no	Screw-in	Assembled	N/S
19331426 (disc.)	Rect alum	12363401	Alum	300	118	2.250	1.880	Rect	Square	no	Screw-in	Bare 3400	N/S
19418910	Oval alum	12363391	Alum	290	110	2.250	1.880	Oval	Square	no	Screw-in	Semi-open, oval port	194
19418909	Oval alum	12363391	Alum	290	110	2.190	1.880	Oval	Square	no	Screw-in	Semi-open, oval port	194
19331422 (disc.)	Oval alum	12363391	Alum	290	110	2.190	1.880	Oval	Square	no	Screw-in	Bare 3392	N/S
19331429	572/620 Head	—	Alum	310	118	2.250	1.880	Rect	Square	no	Screw-in	ZZ572/620	194
19331430	572/720R Head	—	Alum	310	118	2.250	1.880	Rect	Square	no	Screw-in	ZZ572/720R	194
19435585	SP502/605 Head	12363391	Alum	290	114	2.250	1.880	Oval	Square	no	Screw-in	CNC Ported Assembly	194
19435586	SP502/605 Head	12363391	Alum	290	114	2.250	1.880	Oval	Square	no	Screw-in	CNC Ported Bare Head	194
19431810	RS-X Spread-Port	—	Alum	449	70	2.450	1.800	Rect	Square	no	Shaft	CNC Ported Assembly	195
19419908	RS-X Spread-Port	—	Alum	449	70	2.450	1.800	Rect	Square	no	Shaft	CNC Ported Bare Head	195
19432393	RS-X Spread-Port	—	Alum	449	70	2.450	1.800	Rect	Square	no	Shaft	Unported Bare Head	195

SERVICE REPLACEMENT HEADS

Chevrolet Performance service replacement cylinder heads are direct replacements on most 1990-and-later GM Big-Block 454-cubic-inch and 502-cubic-inch engines. These cylinder heads meet GM's stringent quality standards and provide excellent service and durability not found in used cylinder heads. The cylinder heads have rectangular intake ports.*





Bare Cast-Iron Gen V and Gen VI Cylinder Head (exhaust)

Service Replacement Head Technical Notes:

- Cast-iron
- Rectangular intake ports
- Machined for 2.180"/1.880" (3/8" stems) valves
- Non-adjustable rocker arm design
- Heads have heat risers
- Will not work on production Mark IV cylinder blocks

*They are an ideal head for those Big-Block enthusiasts who want more power.

Part Number	Description	Technical Notes
12562925	 Bare Cast-Iron Gen V and Gen VI Cylinder Head	Bare cast-iron head; 118cc combustion chambers; 7/16" accessory bolt holes
12562926	 Bare Cast-Iron Gen V and Gen VI Cylinder Head (not shown)	Bare cast-iron head; Machined for 2.180"/1.880" 3/8" stem valves; 118cc combustion chambers; 3/8" accessory bolt holes (otherwise identical to P/N 12562920)
12562920	 Cast-Iron Gen V and Gen VI Cylinder Head Assembly (not shown)	Cast-iron head; Completely assembled with 2.180"/1.880" valves; 118cc combustion chambers; Uses P/N 12562925 bare casting



Bare Cast-Iron Gen V and Gen VI Cylinder Head (intake)



Bare Cast-Iron Gen V and Gen VI Cylinder Head (combustion chamber)



Parts intended for competition use only. See page 2 for details.



Additional components required for installation. See chart on page 196.



Performance

193

ALUMINUM BOWTIE CYLINDER HEADS

Chevrolet Performance Bowtie high-performance cylinder heads are ideal for drag-strip performance. They provide a broad power range with ample low-end torque, excellent throttle response, good mid-range torque and enough top-end power to beat your competitors to the finish line. Chevrolet Performance Bowtie cylinder heads are designed for high-performance applications, with thick deck surfaces and high-velocity airflow passages. The heads are manufactured to precise machining tolerances.

Chevrolet Performance Bowtie cylinder heads are available in either rectangular or oval intake port configurations. Rectangular intake ports are larger in volume and are designed to enhance high-rpm horsepower. Cylinder heads with oval intake ports are smaller in volume and are designed for greater low-rpm torque. Oval port heads are best where lots of bottom end, off-the-line power is desired.



Bowtie 572/620 Cylinder Head Assembly

Bowtie Cylinder Head Technical Notes:

- Made from 356-T6 aluminum
- Available in rectangular- or oval-port designs
- Will work on Mark IV and Gen V, VI blocks
- 3/16"-thick decks
- As-cast intake and exhaust ports
- No heat risers
- 1.55" valve spring seat diameter
- Heli-coiled 7/16" screw-in rocker stud holes
- Designed for use with 3/8" pushrods
- Use intake gasket P/N 12366985 and bolt kit P/N 12367959
- Use head gasket P/N 12363414 for bores to 4.370" and P/N 12363411 for bores 4.470" to 4.540" (Mark IV)
- Use head gasket P/N 12363412 for bores to 4.370" and P/N 12363411 for bores 4.470" to 4.540" (Gen V, VI)
- Use head bolt kit P/N 12367779



Bowtie 572/620 Cylinder Head Assembly (intake)



Bowtie 572/620 Cylinder Head Assembly (exhaust)



Bowtie 572/620 Cylinder Head Assembly (combustion chamber)

Rectangular Port Heads

Part Number	Description	Technical Notes
19331429	Bowtie 572/620 Cylinder Head Assembly	Aluminum head assembly; Used in the 572/620 Chevrolet Performance crate engine; Completely assembled with 2.190"/1.880" 1/32" stem valves; Valve springs for hydraulic roller cams for up to .632" lift; 310cc rectangular intake port; 118cc exhaust port—raised 5/8"; 118cc combustion chamber
19331430	Bowtie 572/720R Cylinder Head Assembly (not shown)	Aluminum racing head assembly; Used in the 572/720R Chevrolet Performance crate engine; Completely assembled with 2.250"/1.880" 1/32" stem valves; Mechanical roller valve springs—not for use with hydraulic roller cams; Good to .720" valve lift; 310cc rectangular intake port; 118cc exhaust port—raised 5/8"; 118cc combustion chamber



Bowtie Oval-Port Aluminum Cylinder Head (exhaust)



Bowtie Oval-Port Aluminum Cylinder Head (intake)



Bowtie Oval-Port Aluminum Cylinder Head (combustion chamber)

Oval Port Heads

Part Number	Description	Technical Notes
19435585	SP502/605 Oval-Port Aluminum Cylinder Head, CNC-ported – Assembled	Production design used on the SP502/600 crate engine; Fully machined and assembled; Use with minimum bore of 4.47"; 290cc intake port; 110cc exhaust port; 114cc combustion chamber; 2.250"/1.880" stainless steel valves with 11/32" stem OD; Beehive-type valve springs with 1.307" O.D. (large end) designed for hydraulic-roller camshaft; Recommended head gasket P/N 12363411; Recommended bolt kit P/N 12367779
19435586	SP502/605 Oval-Port Aluminum Cylinder Head, CNC-ported – Bare	Production design used on the SP502/600 crate engine; Fully machined, ready for assembly; Use with minimum bore of 4.470"; 290cc intake port; 110cc exhaust port; 114cc combustion chamber; Machined for 2.250"/1.880" valves with 1/32" stem OD; Recommended head gasket P/N 12363411; Recommended bolt kit P/N 12367779
19418909	Bowtie Oval-Port Aluminum Cylinder Head Assembly	Completely assembled with 2.190"/1.880" 1/32" stem valves; 290cc oval intake ports; 110cc exhaust ports; 110cc combustion chambers
19418910	Bowtie Oval-Port Aluminum Cylinder Head Assembly (not shown)	Completely assembled with 2.250"/1.880" 1/32" stem valves; 290cc oval intake ports; 110cc exhaust ports; 110cc combustion chambers

RS-X ALUMINUM SPREAD-PORT CYLINDER HEADS

The high-rpm airflow requirements of Pro Stock engines influenced the design of Chevrolet Performance's RS-X spread-port Big-Block cylinder head design, which is used on the ZZ632 Deluxe crate engine. It uses a raised, symmetrical port design rather than the conventional Big-Block siamese design, for greater port-flow equalization. The heads are designed for large-displacement high-performance applications, where high-rpm airflow is a must for maximum performance. They're used with a shaft-style roller rocker system. Assembled heads feature 2.450/1.800-inch titanium valves and beehive-type springs.

NOTE: Must be installed only on blocks with four valley lugs per bank.

RS-X Spread-Port Cylinder Head Technical Notes:

- Made from 356-T6 aluminum
- Will fit large-bore standard- and tall-deck blocks
- 0.750" deck
- Intake port volume (nominal): 449 cc
- Exhaust port volume (nominal): 161 cc
- Chamber volume (nominal): 70 cc
- Intake flow: 481 cfm @ 0.787"
- Exhaust flow: 347 cfm @ 0.787"
- Rocker bar required
- Designed for shaft-mount roller rocker arms
- Designed for 7/16" pushrods
- Requires custom exhaust headers









RS-X Spread-Port Cylinder Head Assembly (intake)



RS-X Spread-Port Cylinder Head Assembly (exhaust)



RS-X Spread-Port Cylinder Head Assembly (combustion chamber)

Part Number	Description	Technical Notes
19431810  	RS-X Spread-Port Aluminum Cylinder Head, CNC-ported – Assembled	Fully machined and assembled; 449cc intake port; 161cc exhaust port; 70cc combustion chamber; 2.450"/1.800" titanium valves with 5/16" stem OD; Ovate wire-type beehive valve springs with 1.589" OD (large end); Steel 10-deg. retainers with 1.115" OD
19419908  	RS-X Spread-Port Aluminum Cylinder Head, CNC-ported – Bare	Fully machined, but without valves and valve springs; Seats and guides installed; 449cc intake port; 161cc exhaust port; 70cc combustion chamber
19432393  	RS-X Spread-Port Aluminum Cylinder Head – Bare (not shown)	Un-ported bare head casting; Valve seats and guides included, but delivered uninstalled; As-cast ports and chambers; Un-machined deck



RS-X Spread-Port Cylinder Head, CNC-ported – Bare (exhaust)



RS-X Spread-Port Cylinder Head, CNC-ported – Bare (combustion chamber)



Parts intended for competition use only. See page 2 for details.



Additional components required for installation. See chart on page 196.



CYLINDER HEAD GASKETS

Secure sealing between the cylinder heads and the block is a critical component of making reliable horsepower, so Chevrolet Performance puts the same engineering excellence and manufacturing precision into their gaskets, head bolts, and cylinder head studs as the blocks and heads they secure. Big-Block cylinder head gaskets are available in a variety of materials and thicknesses. Piston-to-head clearances should be considered when selecting gaskets. Use Gen V for 1991–1992 applications. Gasket packages contain one gasket unless otherwise specified.



Composition Head Gasket – 1965–1990



Head Gasket – 572 Engine

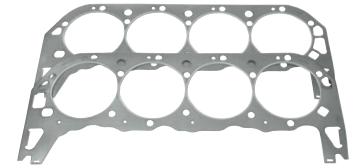

Head Gasket Kit – 502 Engine

Rectangular Port Heads

Part Number	Description	Technical Notes
12363414	Composition Head Gasket – 1965–1990	With pre-flattened copper wire ring and PermaTorque®/Blue Stripe® coating for engines with aluminum heads; Bore sizes between 4.250" and 4.370"; Use with Mark IV (1965–1990) engines only; Compressed thickness is .039"
12363412	Composition Head Gasket – 1991–newer (not shown)	For 1991-and-newer Gen V and Gen VI Big-Blocks with aluminum heads and 4.250" to 4.370" bore size; Has pre-flattened wire ring and stainless core, which make it ideal for saltwater marine use; Compressed thickness is .039"
12555728	Head Gasket – 454 Engine (not shown)	Head gasket for 1991–2000 Gen V 454 Big-Blocks
12366984	Head Gasket Kit – 502 Engine	For all Gen V and Gen VI 502 Big-Blocks with cast-iron heads; Has additional water hole for improved cooling of siamesed cylinder walls; Includes 2 gaskets (right and left) per package; Compressed thickness is .041"
12363411	Composition Head Gasket – 1991–newer (not shown)	For Gen V and Gen VI Big-Blocks with aluminum heads and 4.375" to 4.540" bore size; Has pre-flattened wire ring and stainless core, which make it ideal for saltwater marine use; Compressed thickness is .039"
88961561	Head Gasket – 572 Engine	With pre-flattened wire ring for all 572 Big-Blocks with either cast-iron or aluminum heads; Compressed thickness is .030"

Head Bolts and Studs

Part Number	Description	Technical Notes
12367779	Cylinder Head Bolt Kit (not shown)	Universal kit for cast-iron and aluminum Big-Block heads; Includes (8) 7/16" - 14 x 2.08" bolts P/N 88960334, (24) 7/16" - 14 x 4.060" bolts P/N 88960333, (8) 7/16" - 14 x 5.06" bolts P/N 88960332, and (40) hardened washers P/N 14011040; Use part numbers above for replacement parts; Use thread sealant on all Big-Blocks except 502, due to blind bolt holes; not for use on ZZ632 or RSX cylinder heads.

! Cylinder Heads: Additional Required Components

Part Number	Gaskets (Quantity)	Bolts (Quantity)	Spark Plug	Engine Application
12562920	14097001 (2) OR 12555728 (2)	10141204 (24), 10141205 (8)	19355200	19433157, 19433409
12562926	14097001 (2) OR 12555728 (2)	10141204 (24), 10141205 (8)	19355200	19433157, 19433409
12562925	14097001 (2) OR 12555728 (2)	10141204 (24), 10141205 (8)	19355200	19433157, 19433409
19418910	12363411 (2)	12367779 (1 Kit)	19307141	12499121, 12497323, 19433160
19418909	12555728 (2)	88960333 (16), 88960334 (8)	19307141	19433410
19331430	88961561 (2)	88960333 (16), 88960334 (8)	19354424	12498826, 19331585
19331429	88961561 (2)	88960333 (16), 88960334 (8)	19382850	19331581

VALVES

Intake Valves

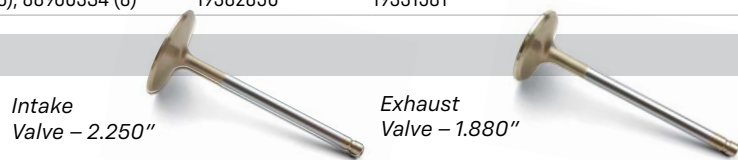

Intake Valve – 2.250"

Exhaust Valve – 1.880"

Part Number	Valve Size	Stem Size	Description
12556317	2.190"	3/8"	Stock replacement valve for Gen V and Gen VI 454 and 502 HO engines
12366986	2.190"	11/32"	Stainless-steel valve with undercut chrome-plated stems, single-groove design, hardened tips; Used on ZZ454, ZZ427 and the Anniversary Edition 427 crate engines
12366987*	2.250"	11/32"	Stainless-steel valve with undercut chrome-plated stems, single-groove design, hardened tips; Used on ZZ502 and ZZ572

*Item has been discontinued. See dealer for available stock.

Exhaust Valves

Part Number	Valve Size	Stem Size	Description
14097049	1.880"	3/8"	Stock replacement valve for Gen V and Gen VI 454 and 502 HO engines
12366988	1.880"	11/32"	Stainless-steel valve with undercut chrome-plated stems, single-groove design, hardened tips; Used on ZZ454, ZZ427 and the Anniversary Edition 427 crate engines
88963128	1.880"	11/32"	Stainless-steel valve with undercut chrome-plated stems, single-groove design, hardened tips; Used on ZZ502 and ZZ572



VALVE SPRINGS AND COMPONENTS

Dual Valve Spring – 1.540"



Valve Spring Retainer



Valve Spring Key



Valve Springs

Part Number	Spring Type	Outside Diameter	Pressure at Installed Height	Retainer Part Number	Valve Seal Kit	Technical Notes
88963934	Dual Spring	1.540"	197# @1.800"	12366990	88963936	Used with 572/620 HP engines; 1 valve spring, order 16 per engine

Valve Spring Components

Part Number	Description	Technical Notes
12550421	Valve Spring Retainer	For 1991-and-newer Gen V and Gen VI engines
3947880	Valve Spring Key	Hardened steel split locks for production and racing engines; Color-coded purple; Sold individually
12550422	Valve Stem Seal (not shown)	Seal for 1991-and-newer Gen V and Gen VI engines; The valve guide boss must be machined slightly for seal to retain clearance when using high-lift cams
88963936	Valve Spring Seal (not shown)	Use with all 572 engines
3875916	Spring Shim (not shown)	55/64" I.D. x 1 31/64" O.D. x .015" thick
88963937	Spring Shim (not shown)	Shim for all 572 engines
88963935	Valve Spring Locator (not shown)	Valve spring locator for setting the valve spring in the right location on all 572 engines

ROCKER ARMS

Steel Rocker Arms – Steel rocker arms are designed for long-term durability. Chevrolet Performance steel rocker arms are intended for 454- and 502-cubic-inch Big-Blocks. Rocker arm kits include one rocker arm and ball.

Aluminum Roller Big-Block Rocker Arm for 7/16" Studs – Chevrolet Performance aluminum roller rocker arms have bearings and fulcrums with an extra-wide design for improved load distribution. The rockers are lubricated with pressurized oil. The rockers have a 1.7:1 ratio for 7/16" studs. The roller-tip axle is made from 4130 steel and the roller tip is machined and ground from 8620 steel.

NOTE: Not for use with production-height valve covers.



Roller Rocker Arm Set, 1.7:1 Ratio

Part Number	Description	Technical Notes
19355321	L-18 Design Steel Long-Slot Rocker Arm, 1.7:1 Ratio (not shown)	These 1.7:1 ratio hardened steel rocker arms have elongated slots to provide extra clearance for high-lift (.600" and greater) camshafts; Use with all 396-502 Big-Block heads with adjustable rockers; Each assembly includes rocker arm as well as the ball and nut NOTE: Can be used on any Gen V or Gen VI by using rocker stud P/N 12368941. Will not work with ZZ502 valve covers.
19210726	Aluminum Roller Rocker Arm Set, 1.7:1 Ratio	Set includes 16 roller rocker arms and nuts for 7/16" studs; Used on 572-cubic-inch Big-Block engines; Use P/N 19244484 for single replacement part

PUSHRODS

Chevrolet Performance offers a complete line of premium-quality, heavy-duty pushrods for most GM Big-Block engines. Pushrods are that critical link between the camshaft and the rocker arms. These seemingly innocuous parts play a very important role in the combustion process. Two materials are used: 1010 mild steel for high-performance street cars, power boats, and limited competition applications, and 4130 chrome-moly steel for maximum-performance racing engines. Chevrolet Performance pushrods are case-hardened for use with pushrod guideplates. Pushrods are available in standard and extended lengths. Check the usage chart below to verify proper applications.



Intake Pushrod, Roller Lifter Style

Part Number	Material	Diameter	Length	Usage	Port	Description
10227762	1010 steel	3/8"	7.592"	Hyd. roller	Intake	(1) heavy-duty heat-treated .060" for use in Gen VI 454 and 502 engines with hydraulic roller lifters
10227763	1010 steel	3/8"	8.569"	Hyd. roller	Exhaust	(1) heavy-duty heat-treated .060" for use in Gen VI 454 and 502 engines with hydraulic roller lifters
12368081	1010 steel	3/8"	7.592"-8.569"	Hyd. roller	—	Kit of (8) P/N 10227762 and (8) P/N 10227763
88961559	4130 steel	3/8"	7.900"	Hyd. roller	Intake	Chrome-moly 1-piece for 572/620 (Tall Deck Block)
88961558	4130 steel	3/8"	8.900"	Hyd. roller	Exhaust	Chrome-moly 1-piece for 572/620 (Tall Deck Block)
88962284	4130 steel	3/8"	8.550"	Mech. roller	Intake	Chrome-moly 1-piece for 572/720 (Tall Deck Block) for engines built May 2010 or prior
88962283	4130 steel	3/8"	9.525"	Mech. roller	Exhaust	Chrome-moly 1-piece for 572/720 (Tall Deck Block) for engines built May 2010 or prior
19330131	4130 steel	3/8"	9.750"	Mech. roller	Exhaust	Chrome-moly 1-piece for 572/720 (Tall Deck Block) built after May 2010
19330132	4130 steel	3/8"	8.750"	Mech. roller	Intake	Chrome-moly 1-piece for 572/720 (Tall Deck Block) built after May 2010



VALVE COVERS

Top off your high-performance Big-Block with a pair of handsome Chevrolet Performance valve covers. These stylish, precision-fit valve covers come in a variety of finishes and colors. They're made out of die-cast aluminum or heavy-gauge stamped steel. Quality construction methods provide better sealing and less chance of leakage from deflection caused by over-tightened fasteners. Competition valve covers are designed to clear taller valvetrains.

NOTE: Valve covers are sold in pairs unless otherwise specified.

**12342093** ⓘ**Short Chrome Bowtie Valve Covers**

- Show-quality covers embossed with the famous Bowtie logo and Chevrolet name
- Standard height, for use with 1965–1994 engines
- May not clear brake booster on some Corvette models

**12495488** ⓘ**Custom Aluminum Valve Covers**

- Die-cast aluminum valve covers are black with a brushed aluminum finish on top, revealing the Chevrolet name and Bowtie logo
- Can be finished with a custom engine designation badge (see page 199) not included
- For use on 1965–1994 engines
- Includes 2 covers, 1 grommet P/N 10198941, 1 grommet P/N 10198949, oil cap P/N 15681150 and 14 retaining bolts

**12371244** ⓘ**Aluminum Competition Design Valve Covers**

- Display the Chevrolet name and Bowtie logo in natural aluminum finish, or paint to match engine or vehicle color
- No holes for PCV or oil fill, but bosses for drilling them
- Can be used on most Big-Block Chevrolet cylinder heads
- Use P/N 12370836 for single replacement part

NOTE: Use with valve cover gasket P/N 19433398.

**25534374** ⓘ**Aluminum Competition Design Valve Covers – Orange Powder-Coat**

- Display the Chevrolet name and Bowtie logo in orange powder-coated covers
- One hole each cover for PCV or oil fill
- Can be used on most Big-Block Chevrolet cylinder heads

NOTE: Use with valve cover gasket P/N 19433398.

**19202588** ⓘ**Valve Covers – "427 Chevrolet," Natural Appearance**

- Natural finish
- Used on the Anniversary Edition 427 crate engine
- Can be used on any Big-Block engine

**19202589** ⓘ**Valve Covers – "427 Chevrolet," Black Powder-Coat**

- Used on the ZZ427/480 crate engine
- Can be used on any Big-Block engine

**12499200** ⓘ**Valve Covers – "572 Chevrolet"**

- Used on all 572-cubic-inch crate engines and can be used on most Big-Blocks
- Cast aluminum with "572 Chevrolet" as part of the casting
- One cover has oil fill and breather holes and the second cover has the breather hole only

NOTE: Requires push-in oil cap P/N 12341993, breather P/N 25534355 and breather tube P/N 88962074, which incorporates a baffle in the tube.



19421390

Valve Covers – Orange with "632"

- Used on the ZZ632 crate engine and can be used on all Big-Block cylinder heads
- Cast aluminum construction with integrated oil fill on one cover and a breather outlet on the other
- Chevy Orange finish with raised and machined "632" logo and fins
- Includes 2 covers and 2 grommets

NOTE: Requires push-in oil cap P/N 12341993, breather P/N 25534355 and breather tube P/N 88962074, which incorporates a baffle in the tube.



19421388

Valve Covers – Black with "502"

- Similar to cover design P/N 19421390 above, but with black finish and "502" logo
- Can be used on all Big-Block engines



19421392

Valve Covers – Orange with "Chevrolet Bowtie" (not shown)

- Similar to cover design P/N 19421390 above, but with the Chevrolet Bowtie logo
- Can be used on all Big-Block cylinder heads

Valve Covers – Black with "Chevrolet Bowtie"

- Similar to cover design P/N 19421390 above, but with black finish and Chevrolet Bowtie logo
- Can be used on all Big-Block cylinder heads

VALVE COVER COMPONENTS



ZZ572 Breathers



Push-In Oil Filler Cap



Valve Cover Badge – "502"



Rocker Adjusting Nut

Hardware and Breathers

Part Number	Description	Technical Notes
88962074	Oil Baffle Tube (not shown)	Pushes easily into most valve covers that have an oil baffle; Requires breather P/N 25534355, used on ZZ572 engines
25534355	ZZ572 Breathers	Special breathers for the ZZ572 valve covers; Chrome breathers are 1-3/8", hose-clamp-style with the Bowtie logo on top; Use with oil baffle tube P/N 88962074; Includes 2 breathers
12341993	Push-In Oil Filler Cap	For valve covers with 1.220" hole
19131218	Chrome Push-In Breather (not shown)	2-3/4" O.D. x 1-1/2" tall with 3/8" nipple; Use with rubber grommet P/N 3894337
3894337	Rubber Grommet – Bowtie Valve Covers (not shown)	Has 15/16" I.D. x 7/8" O.D.; Can be used to plug the oil filler hole in Bowtie valve covers or to mount a push-in breather
19433398	Valve Cover Gasket (not shown)	Steel-reinforced gasket fits all Big-Block Chevy valve covers; Order 2 per engine

Valve Cover Badges

Part Number	Description	Technical Notes
12363952	Valve Cover Badge – "454" (not shown)	Designed to fit mounting area on valve covers P/N 12495488 (see page 198), but these good-looking badges will also fit some other Big-Block valve covers. NOTE: 1 badge per package. Order 2 per engine.
12363953	Valve Cover Badge – "502"	Designed to fit mounting area on valve covers P/N 12495488 (see page 198), but these good-looking badges will also fit some other Big-Block valve covers. NOTE: 1 badge per package. Order 2 per engine.

Rocker Arm Studs and Accessories

Part Number	Description	Technical Notes
3896648	Rocker Adjusting Nut	Positive locking 7/8"-20 nut for all Big-Block V-8s



Valve Covers: Additional Required Components

Part Number	Gaskets (Qty)	Bolts (Qty)	Grommets (Qty)	Oil Fillers (Qty)	Engine Application
12342093	19433398 (2)	88961871 (4)	12341988 (1)	12341993 (1)	12499121, 19433162, 19433160, Mark IV, V, VI BB
12495488	19433398 (2), OR Mark IV, V, VI (2)	25520079	10198941 OR 3989350	15681150	12499121, 19433162, 19433160, Mark IV, V, VI BB
12371244	19433398 (2)	88961871 (4)	N/A	12341993 (1)	19331583, 19331581, 19331583, 19331585, 19331581
25534374	19433398 (2)	88961871 (4)	N/A	12341993 (1)	19331583, 19331581, 19331583, 19331585, 19331581
12499200	19433398 (2)	88961871 (4)	12341988 (1)	12341993 (1)	19331583, 19331581, 19331583, 19331585, 19331581
19202588	19433398 (2)	88961871 (4)	12341988 (1)	12341993 (1)	19331583, 19331581, 19331583, 19331585, 19331581
19202589	19433398 (2)	88961871 (4)	12341988 (1)	12341993 (1)	19331583, 19331581, 19331583, 19331585, 19331581



Additional components required for installation. See chart above.



GUIDE PLATES AND VALVE LIFTERS



Pushrod Guide Plate (3/8")



Hydraulic Performance Lifter Kit



Hydraulic Lifter Kit

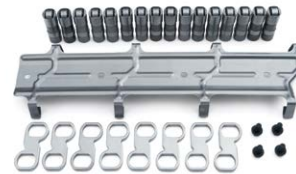

Hydraulic Roller Lifter Installation Kit



Mechanical Roller Lifter - ZZ572/720R

Big-Block Guide Plates

Part Number	Description	Technical Notes
3860038	Pushrod Guide Plate - 3/8"	Designed for all 1965-1990 iron and aluminum cylinder heads with 3/8" diameter pushrods; Slotted style with hardened steel construction, aligns rocker arms with valve stem tips on Big-Block's splayed-valve head; 8 required for each engine. NOTE: Use with screw-in rocker stud P/N 3921912.
3879620	Pushrod Guide Plate - 7/16" (not shown)	Similar to guide plate described above, but for use with heavy-duty 7/16" diameter pushrods
12562369	Pushrod Guide Plate - Gen V 454/502 style (not shown)	Used on all Gen V 454 and 502 engines with 3/8" diameter pushrods

Valve Lifters and Components

Part Number	Description	Technical Notes
19432621	Hydraulic Performance Lifter Kit - set of 16	High performance hydraulic lifter set used on ZZ632 crate engine and tested to 7000rpm! Features ultra high flow pushrod seats and reduced mass componentry for higher limiting speeds and to accommodate aggressive camshaft designs; For single service replacement use P/N 19432401.
12371044	Hydraulic Lifter Kit - set of 16	For use on all 396, 427, 454, and 502 engines that use hydraulic flat tappet lifters; For single-service replacement use P/N 5232720
12722012	Hydraulic Roller Lifter - ZZ572/620 (not shown)	Roller valve lifters used on the ZZ572/620 engines; Use with camshaft P/N 19210721, intake pushrod P/N 88961559, exhaust pushrod P/N 88961558 and rocker arm P/N 19210726
12371056	Hydraulic Roller Lifter Installation Kit	Hydraulic roller lifter retainer kit can be used on all Gen VI 454 and 502 engines that are machined for hydraulic roller lifters; Includes 16 roller lifters P/N 12722013, 8 lifter guides, 1 lifter guide retainer and 4 retainer bolts; For single-service replacement lifter, use P/N 12722013 NOTE: These lifters allow more oil to the rocker arms than the late-model truck roller lifters.
19356323	Mechanical Roller Lifter - ZZ572/720R	Mechanical roller valve lifters used on the ZZ572/720R engines; Use with camshaft P/N 19210722, intake pushrod P/N 88962284, exhaust pushrod P/N 88962283 and rocker arm P/N 19210726; Kit of 2 lifters and tie bar. 8 required per engine.
12551397	Roller Tappet Guides (not shown)	Roller tappet guides used with all 502 engines and 454 HO engines; Used with roller camshaft engines; Sold individually; order 8 per engine
12551399	Roller Tappet Guide Retainer (not shown)	Roller tappet guide retainer used with all 502 engines and 454 HO engines; Used with roller camshaft engines; Order only 1 per engine



CAMSHAFTS

The camshaft is one of the most important factors in determining an engine's overall performance profile and capability. The wide array of precision-engineered, extensively tested camshafts from Chevrolet Performance allows you to choose the best cam for your application. In order to avoid possible engine damage, a distributor with a melonized steel gear must be used with steel camshafts.

Part Number	Description	Duration @ .050" Lift (deg)	Maximum Lift (in)	Lobe Centerline (deg)	Technical Notes
12366543	Steel hydraulic roller	I: 224 / E: 234	I: .527 / E: .544	110	For 502/502 special engine; Must use distributor gear P/N 19432310
19418730	Steel hydraulic roller	I: 246 / E: 257	I: .649 / E: .650	114	For SP502/605 Deluxe engine
24502611	Steel hydraulic roller	I: 211 / E: 230	I: .510 / E: .540	112	For 454 and 502 HO engines; Must use distributor gear P/N 19432310
19210721	Steel hydraulic roller	I: 254 / E: 264	I: .632 / E: .632	112	For ZZ572/620 Deluxe engine
19210722	Mechanical roller	I: 278 / E: 282	I: .714 / E: .714	112	For ZZ572/720R Deluxe engine

Camshaft Components

Part Number	Description	Technical Notes
12499434	Camshaft Bearings - 572 Engine	5 standard-size premium camshaft bearings for the ZZ572 engine



Camshaft Bearings - 572 Engine

PISTONS AND PISTON RINGS

Pistons and rings operate in a very explosive environment, so they have to be extremely tough. Chevrolet Performance pistons and rings are designed to withstand the rigors of high-performance engines. The pistons are factory-tested for quality assurance. Chevrolet Performance pistons are sold in a variety of sizes and compression ratios. There are pistons for GM Big-Block engines ranging in displacement from 427 cubic inches to 572 cubic inches. Pistons are sold individually and are fitted with wrist pins.

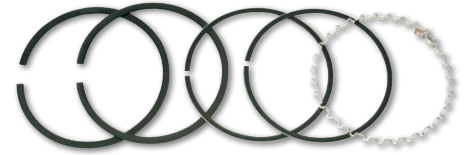

NOTE: Part numbers are for one piston; order eight per engine.

Big-Block Pistons

Part Number	Engine Size	Bore Size	Oversize	Rod Length	Pin Type	Compression Ratio	Chamber Size	Ring Size	Description
12533507	502	4.470"	–	6.135"	Pressed	8.75:1	118cc	5/64", 1/16", 3/16"	Forged Gen V and Gen VI 502 replacement
19434228	502	4.470"	–	6.135"	Floating	10.5:1	114cc	1/16", 1.5mm, 3.0mm	Forged SP502/605
88962925	572	4.560"	–	6.535"	Floating	9.6:1	118cc	1/16", 1/16", 3/16"	Forged 572/620
88963227	572	4.560"	–	6.535"	Floating	12.0:1	118cc	1/16", 1/16", 3/16"	Forged 572/720R

Big-Block Piston Rings

Part Number	Bore Size	Oversize	Ring Thickness	Description
12523921	4.250"	Standard	5/64", 5/64", 3/16"	Standard-size ring pack for Gen V 454 HO
12524293	4.470"	Standard	5/64", 1/16", 3/16"	Standard-size low-tension ring pack for all 502 engines
12524294	4.470"	+030"	5/64", 1/16", 3/16"	Oversize low-tension ring pack for all 502 engines
19356319	4.560"	Standard	5/64", 1/16", 3/16"	Standard-size ring pack for 572 engines

CONNECTING RODS AND COMPONENTS



Forged Steel Connecting Rod



572 Connecting Rod



572 Connecting Rod Bearing Kit

Part Number	Description	Technical Notes
19170198	Forged Steel Connecting Rod	Magnafluxed 4340 steel with heavy-duty 7/16" bolts; Machined for pressed piston pins and color-coded white; Used in Gen V 454 and 502 engines; 6.135" c-c length
19211226	427 Forged Connecting Rod (not shown)	4340 steel with 7/8" heavy duty bolts; Machined for pressed piston pins; Used in 427 Anniversary and ZZ427 engines; Big end chamfered for large crank pin radius; 6.135" c-c length
88962926	572 Connecting Rod	Forged 4340 steel H-beam for all 572 engines; 6.535" c-c length; Use rod bearing P/N 88961556
88961556	572 Connecting Rod Bearing Kit	Standard-size, premium connecting rod bearings; Includes all 8 rod bearing sets

CRANKSHAFTS

Crankshafts are a critical, central component of any engine. Strength and durability are important traits of a great crankshaft. Chevrolet Performance crankshafts are precision-engineered to be both strong and durable. Chevrolet Performance understands how catastrophic crankshaft failure can be, so that's why our crankshafts are manufactured to such exacting specifications and tested to withstand the forces of high-performance engines. These crankshafts are the same tough parts used in Chevrolet Performance crate engines.



Crankshaft, Forged Steel (Gen V and Gen VI 502)

Part Number	Description	Technical Notes
14096983	Crankshaft, Forged Steel (Gen V and Gen VI 454) (not shown)	Externally balanced; Forged 1053 steel crankshaft with 1-piece rear main seal
10183723	Crankshaft, Forged Steel (Gen V and Gen VI 502)	Externally balanced; Cross-drilled; Nitride-treated forged 1053 steel crankshaft with 1-piece rear main seal; Forging P/N 14097044
14061685	Roller Pilot Bearing (not shown)	Used in high-performance manual transmission applications



Parts intended for competition use only. See page 2 for details.



Performance

BALANCERS

Balancers are relatively small parts that play a big role in helping engines run smoothly. Balancers are also known as torsional dampers or harmonic balancers, which is indicative of how they help control unwanted crankshaft vibrations. By controlling vibrations, Chevrolet Performance balancers help engines run smoothly, which also extends engine life.



Part Number	Description	Technical Notes
19433024	454 and 502 with 4.000" stroke crank, 1970 to present (not shown)	8" outside diameter; Counterweighted for externally balanced engines
88962814	427/572 Balancer	8" outside diameter; This internal balance damper is designed with inner and outer shells; Utilizes matched O-rings to control destructive crankshaft vibrations; Black zinc chromate finish; Laser engraved 360° timing marks
19418278	632 Balancer (not shown)	8" outside diameter; For internally balanced engines; Balancer is shortened for use with 19260247 Big-Block conversion kit

FLYWHEELS AND FLEXPLATES

Chevrolet Performance offers both internally and externally balanced flywheels and flexplates. It is critical that you use the correct design for your specific engine application. Engines with one-piece crankshaft seals require externally balanced flywheels or flexplates (except for ZZ427, ZZ572/620, ZZ572/720R and the Anniversary Edition 427). Check the accompanying charts to find the correct parts for specific engine applications.



P/N 14096987 Flywheel



P/N 12561217 Flexplate

Big-Block Flywheels

Part Number	Year of Engine	Outside Diameter	Crank Flange Bolt Pattern	Clutch Diameter	Starter Ring Gear Teeth	Technical Notes
14096987	1991-present	14"	3.580"	11"	168	Lightweight nodular iron; For externally balanced engines
12582964	1965-present	14"	3.580"	11.500"	168	Used with 427 or 572 crate engine; Internally balanced

Big-Block Flexplates

Part Number	Year of Engine	Outside Diameter	Crank Flange Bolt Pattern	Converter Bolt Pattern	Starter Ring Gear Teeth	Technical Notes
10185034	1991-present	14"	3.580"	10.750" and 11.500"	168	Use with forged steel crank; Has dual-converter bolt pattern (502 & 454 1-piece rear main seal); For externally balanced engines
12561217	1991-present	14"	3.580"	11.500"	168	427 crate engine production internally balanced (.100" thick)
471598	1965-present	14"	3.580"	10.750" and 11.500"	168	For internally balanced engines; Use with 572/620 crate engine; Has dual-converter pattern (.120" thick)
14001992	1970-1990	14"	3.580"	11.500"	168	For externally balanced 454 Mark IV 2-piece rear main seal engines

Bolts and Dowels

Part Number	Description	Technical Notes
12337973	Flywheel Bolt (not shown)	Fits all Chevy Small-Block V-8, Big-Block V-8 and 90° V-6 engines; Sold individually; 6 required per engine
10046031	Flywheel Dowel (Big-Block, not shown)	Highly recommended for all high-performance and competition Big-Block engines
12720455	Bellhousing Dowel, Clutch Housing/Transmission Dowel (Big-Block) (not shown)	Use with Big-Block engine; Sold individually; 2 required per engine
3727207	Flexplate Bolt (not shown)	Fits all Chevy Small-Block V-8, Big-Block V-8 and 90° V-6 engines; Sold individually; 6 required per engine

TIMING CHAINS AND SPROCKETS

Chevrolet Performance's strong, accurate timing chains and sprockets provide top performance and dependable service.



Timing Chain Kit – 502, second-design Gen VI



Timing Chain – 502, second-design Gen VI



Camshaft Bolt

Part Number	Description	Technical Notes
12371053	Timing Chain Kit – 502, second-design Gen VI	Heavy-duty double roller timing chain kit for all second-design 502 Gen VI roller-lifter engines with aluminum front timing cover; Kit includes chain P/N 10114177, crankshaft sprocket P/N 12550039, camshaft sprocket P/N 12551401, camshaft retainer and bolts; Also used in 572
10114177	Timing Chain – 502, second-design Gen VI	Single-roller design for all second-design 502 Gen VI engines; Use with crankshaft sprocket P/N 12550039 and camshaft sprocket P/N 12551401
12554553	Camshaft Dowel Pin (not shown)	
9424877	Camshaft Bolt	5/16"-18 x .75" bolt

WATER PUMPS

Aluminum Water Pump – Short-Style



Cast-Iron Water Pump – Long-Style



Part Number	Description	Technical Notes
19168602	Aluminum Water Pump – Short-Style	Lightweight standard-rotation pump has reinforced snout and large-diameter hub with dual bolt patterns for early- and late-model pulleys; Has short mounting legs; Use with early-design V-belt drive rotation
12708488	Cast-Iron Water Pump – Long-Style	Same standard-rotation pump used on all Chevrolet Performance 454 and 502 crate engines; Not for use with a serpentine belt system

OIL PANS, OIL PUMPS, GASKETS AND COMPONENTS

Oil is an engine's lifeblood, and a high-quality Chevrolet Performance oil pan is what keeps it where it belongs. Properly designed and manufactured oil pans fit right, and when used with matching Chevrolet Performance gaskets, they prevent leaks. We have oil pans for street and competition applications. Oil pans are sold without dipsticks or other hardware unless otherwise noted.



6-Quart Oil Pan – Gen V and Gen VI



Dipstick Tube – 6-Quart



Dipstick Tube – 4-Quart

Oil Pans

Part Number	Description	Technical Notes
10240721	6-Quart Oil Pan – Gen V and Gen VI	6-quart pan fits all 1991-and-newer Gen V and Gen VI, 427, 454, 502 and 572 engines

Dipsticks

Part Number	Description	Technical Notes
12557083	Dipstick – 6-Quart (not shown)	For use with production 6-quart oil pan P/N 10240721; Use oil dipstick tube P/N 12550533 and seal P/N 274244
12550533	Dipstick Tube – 6-Quart	For use with production 6-quart oil pan P/N 10240721; Use oil dipstick P/N 12557083 and seal P/N 274244
274244	Oil Dipstick Tube Seal – 6-Quart (not shown)	For use with the production 6-quart oil pan P/N 10240721; Use oil dipstick tube P/N 12550533 and dipstick P/N 12557083
329231	Dipstick Tube – 4-Quart	Use oil dipstick P/N 3989391
3989391	Dipstick – 4-Quart (not shown)	for all Gen V and Gen VI engines; Use dipstick tube P/N 329231

BIG-BLOCK COMPONENTS



Windage Tray



Windage Tray



Windage Tray –
572 Engine



Oil Pump and Pick-Up
– 572 Engine



Oil Pump Shaft



Oil Filter
Adapter



Oil Cooler
Bypass Valve

Oil Pan Components

Part Number	Description	Technical Notes
14097040	Windage Tray	Use with the Gen V and Gen VI 454 and 502 engines
3967854	Windage Tray	Separates the oil from the spinning crank assembly to reduce aeration of the oil, aids in oil control and minimizes oil slosh under hard braking; Use with oil pan P/N 14091356; Requires 4 mounting studs P/N 3902885
88962187	Windage Tray – 572 Engine	Used on all 572-cubic-inch engines; Use with oil pan P/N 10240721
19131250	Oil Pump and Pick-Up – 572 Engine	For use with all 572-cubic-inch engines; Use with oil pan P/N 10240721, oil pan gasket P/N 19213986 and windage tray P/N 88962187
3865886	Oil Pump Shaft	Heavy-duty all-metal; Intermediate shaft fits all Big-Block engines
19210599	Oil Pump and Pick-Up – Gen V and Gen VI (not shown)	For use with the Gen V and Gen VI 454 and 502 engines with 1-piece rear main seal; Pump has 1.300" gears and will fit Mark IV engines; Distance from the mounting surface to the bottom of the screen is 5.870" NOTE: Tack-welding pick-up tube to pump is recommended.
3955281	Oil Pump Pick-Up (not shown)	Distance from pump mounting surface to lowest point of screen is 4.880" NOTE: Weld or braze the pick-up tube to the pump cover for off-highway applications.
19299222	Oil Filter Adapter (fits Mark IV Blocks only)	Mounts a spin-on cartridge oil filter; Contains a filter bypass valve used on all V-8 engines
25013759	Oil Cooler Bypass Valve	For high-performance and Bowtie Big-Blocks with 4-bolt main bearing caps; Must be installed in the rear hole behind the oil filter adapter bolt to route oil through the cooler

DISTRIBUTORS AND COMPONENTS

The high-quality distributors in this group are interchangeable with Small-Block Chevrolet V-8 components. Chevrolet Performance distributors cannot be used with Tall-Deck Bowtie blocks, except adjustable distributor P/N 10093387.



Distributor – HEI



Distributor – Ram Jet 350
& Ram Jet 502



Distributor – Competition
Adjustable Slip Collar

Part Number	Description	Technical Notes
19432312	Distributor – HEI	Cast aluminum; High-performance mechanical advance curve; Vacuum advance canister included; Use connector P/N 12167658 to attach tachometer and 12-volt power supply wire to distributor; Includes module P/N 19180771, cap P/N 19110931 and rotor P/N 19110934
19420969	Distributor – Ram Jet 350 and Ram Jet 502	Used on the fuel-injected Ram Jet 350 and Ram Jet 502; Includes ignition module P/N 19418839, cap P/N 19166099 and rotor P/N 10477219
10093387	Distributor – Competition Adjustable Slip Collar	Designed primarily for competition use; Billet-aluminum housing, ball-bearing guide and adjustable mechanical-advance assembly; Magnetic pickup provides accurate trigger signals to Chevrolet; CDI Ignition Box (not included); Uses a standard Chevrolet V-8 cap and rotor; Will clear most induction systems; Slip collar that can be adjusted to make up for block or head machining, or a tall-deck Bowtie block
19432310	Distributor Gear (not shown)	Meloned iron gear is required on all Chevrolet Performance crate engines NOTE: Supplied on distributors P/N 19432312.
12167658	Connector – HEI Distributor Power and Tachometer (not shown)	Used to attach the power and tachometer wires to the cap of the HEI distributor
12498335	Coil – HEI (not shown)	Production HEI coil

INTAKE MANIFOLDS, GASKETS AND COMPONENTS

The wide range of Chevrolet Performance intake manifolds are cast-iron and aluminum, for carbureted and fuel-injected applications. These intake manifolds were designed specifically for GM engines, so you know they will deliver optimum performance. Due to the profile of some Chevrolet Performance high-rise intake manifolds, hood clearance should be carefully checked before ordering an intake manifold.

14097092

Intake Manifold – Oval-Port, iron, spread bore

- Economical iron 4-bbl intake manifold
- Fits all 396–502 engines with large oval-port heads

NOTE: Open carburetor spacer is not recommended with use of dual-plane manifolds.



Intake Manifold – Oval-Port,
iron, spread bore

19131359

High-Rise Intake Manifold – Rectangular-Port, square bore, Holley Carburetors

- Aluminum, dual-plane manifold can be used with high-performance cast-iron or aluminum rectangular port heads
- Same as used on 454 HO and 502 HO engine assemblies

NOTE: Ports do not match Bowtie cylinder heads P/N 12363425.

NOTE: Open carburetor spacer is not recommended with use of dual-plane manifolds.



High-Rise Intake Manifold – Rectangular-Port,
square bore, Holley Carburetors

12363420

High-Rise Intake Manifold – Oval-Port

- Designed for all 396–502 engines with GM aluminum heads (1975 and earlier) and large oval-port iron heads
- Has a dual-plane design with spread bore flange and a dual-bolt pattern
- Has no provisions for a hot-air choke, but will accept a divorced choke or electric choke
- Accepts air conditioning and alternator brackets
- Use intake manifold gasket P/N 12366985 and bolt kit P/N 12367959

NOTE: May not fit on many Corvette models. Manifold height is 6" at the rear and 4.5" in front. Check for hood clearance before ordering.

NOTE: Open carburetor spacer is not recommended with use of dual-plane manifolds.



High-Rise Intake Manifold – Oval-Port

12363406

Intake Manifold – Oval-Port, square bore, Holley Carburetors

- Same as manifold P/N 12363420 (see above), but designed for use with a Holley carburetor
- Dual-plane design requires bolt kit P/N 12367959, which includes 16 bolts (8740 chrome-moly $\frac{3}{8}$ "-16 x 1.5" with $\frac{3}{8}$ " hex head and 16 $\frac{5}{8}$ " O.D. washers), and manifold gasket kit P/N 12366985
- Accepts air conditioning and alternator brackets and a late-model water neck

NOTE: Will not fit production Corvettes, and may not fit Chevilles. Manifold carb flange height is 4.450".

NOTE: Open carburetor spacer is not recommended with use of dual-plane manifolds.



Intake Manifold – Oval-Port, square bore,
Holley Carburetors

12363407

CNC-Port-Matched Intake Manifold – Oval-Port, square bore, Holley Carburetors

- Same as P/N 12363406 except it has been CNC-port-matched for GM aluminum oval-port heads with large oval-port heads (1975-and-older), and all aluminum heads with oval ports

NOTE: Open carburetor spacer is not recommended with use of dual-plane manifolds.



CNC-Port-Matched Intake Manifold – Oval-Port,
square bore, Holley Carburetors



Additional components required for installation. See chart on page 206.



Parts intended for competition use only. See page 2 for details.



BIG-BLOCK COMPONENTS



Intake Manifolds, Gaskets and Components continued

88961161  

Intake Manifold – ZZ572/620 Engine, square bore, Holley Carburetors

- Aluminum single-plane intake manifold is used on the ZZ572/620 engine
- The carburetor flange is for a 4150-style carburetor
- Use intake gasket P/N 88962213
- For tall-deck blocks



88962218  

Intake Manifold – ZZ572/720R Engine

- Aluminum single-plane intake manifold is used on the ZZ572/720R engine
- The carburetor flange is for a 4500 Dominator-style carburetor
- Use intake gasket P/N 88962213
- For tall-deck blocks



19366614 

High-Rise Intake Manifold – Tall Deck with Spread-Port Heads

- Used on ZZ632 Deluxe with unique RS-X spread-port heads and Bowtie Sportsman tall-deck block
- Will not fit conventional rectangular- and oval-port heads
- High-rise, open-plenum design
- Accepts 4500-series (Dominator) carburetors and EFI throttle bodies
- Cast aluminum construction



19366625

Valley Plate with Ignition Coil Mounts

- Used on ZZ632 Deluxe with RSX Spread-Port Cylinder Heads, crank-trigger ignition and separate coil-near-plug ignition coils
- Use with spread-port heads (P/N 19431810) with tall-deck block only. Will not fit with standard-deck block
- Attaches to spread-port cylinder heads below separate intake manifold (P/N 19366614)
- Mounting provisions for eight GM ignition coils (not included).
- Ignition coil P/N 12713668 (single unit eight required) uses RS-X ignition wire set P/N 19432012 (not shown)



19421272

Roller Rocker Arms (Shaft Mount) – RS-X Cylinder Head

- Aluminum roller rocker arms for use with RS-X spread-port cylinder head (P/N 19431810), as used on ZZ632/1000 crate engine
- Individual shaft-mount, roller-bearing design
- Will not fit conventional Big Block heads
- 1.8:1 ratio with adjustable design
- Kit includes 16 rocker arms with clear anodized finish
- Must be used with rocker bar 19433684 (two required)



19433684

RS-X Rocker Bar

- Rocker arm base plate for RS-X cylinder head (P/N 19431810)
- Use with shaft-mount Roller Rocker Arms P/N 19432172
- Sturdy Ductile Iron construction
- Two required per engine
- Will not fit conventional Big-Block heads

Gaskets and Components

Part Number	Description	Technical Notes
12555320	Oil Shield	Isolates hot engine oil from the air/fuel mixture
12366985	Gasket – Aluminum Oval-Port Heads	Designed for Big-Block aluminum heads P/N 19418910 and P/N 19418909; Use with manifold P/N 12363406, P/N 12363407 or P/N 12363420
88962213	Intake Manifold Gasket (not shown)	Use on all Big-Block engines with rectangular intake port heads 396- through 572-cubic-inch; Includes 2 gaskets
12506106	Gasket – 454 and 502 Engines (not shown)	Used on 454 and 502 engines; With restricted heat crossover passages; 1 gasket per package; Order 2 per engine
12367959	Bolt Kit – Intake Manifold	For any Big-Block Chevrolet engine; Includes 16 bolts: $\frac{3}{8}$ "-16 x 1.5" with wide, underhead flange with a $\frac{3}{16}$ " hex head; Rated at 170,000 psi and will give consistent torque load; Includes 16 hardened flat washers NOTE: Four of these washers are smaller in diameter for use around the front water passages.

Water Necks

Part Number	Description	Technical Notes
12342024	Chrome Water Neck	Chrome water neck with neoprene O-ring and chrome bolts; For 1966–1975 full-size Chevrolet, Camaro, and Chevelle V-8 engines
10108470	Aluminum Water Outlet (not shown)	



Intake Manifolds: Additional Required Components

Part Number	Gaskets (Qty)	Bolts (Qty)	Engine Application
12464484	12366985 (1)	12497460 (1)	12499121
12464482	12366985 (1)	12367959 (1)	12499121
88961161	88962213 (1)	12367959 (1)	19331583
12363420	12366985 (1)	12367959 (1)	19801332, BB oval-port high-rise
12363407	12366985 (1)	12367959 (1)	12371171, CNC version of 12363406
19131359	12506106 (2)	10198997 (14)	19433409, BB dual-plane
88962218	88962213 (1)	12367959 (1)	19331585



STARTERS

Flywheels with two different diameters are used on Chevrolet Small-Block, Big-Block, and 90° V-6 engines. Large flywheels are 14" in diameter and have 168 teeth on the starter ring gear. Small-diameter flywheels are 12.750" in diameter, with 153 teeth on the ring gear.

This difference in flywheel diameters requires two distinct starter housings. Starter noses used with large-diameter flywheels have two offset bolt holes, while starters for small flywheels have two bolt holes that are parallel to the back of the block. Most Chevy blocks are drilled for both types of starters.



High-Torque Mini Starter



High-Torque Mini Starter – Chrome



Lightweight Starter – (remastered)



Lightweight Starter – Big-Block and Small-Block

Part Number	Description	Technical Notes
19433448	High-Torque Mini Starter	Gear reduction starter is designed for 1958–1996 V-8 and all 90° V-6 engines; Compact design provides increased clearance; Weighs only 10.5 pounds and has a gear reduction of 3.75:1; Equipped with a dual bolt pattern for 12.750" (153-tooth) and 14" (168-tooth) flywheels; Housing can be rotated to clear exhaust systems; Includes starter, mounting bolts, shims, gaskets and electrical connectors
12363128	High-Torque Mini Starter – Chrome	Same as starter P/N 19433448 (above), but with a chrome housing
10465143	Lightweight Starter (remastered)	Lightweight high-performance starter was originally used on 1993–1997 Camaros and Firebirds with the LT1 engine; Can be used on any Small-Block or Big-Block engine with a 12.750", 153-tooth flywheel
19302919	Lightweight Starter – Big-Block and Small-Block	High performance starter can be used on Big-Block and Small-Block engines with a 14", 168-tooth flywheel



Starters: Additional Required Components

Part Number	Bolts (Qty)	Engine Application
19433448	12338064 (2)	Big-Block
10465143	12338064 (2)	Big-Block
19302919	12338064 (2)	Big-Block and 19433162
12363128	12338064 (2)	Big-Block

CARBURETORS AND THROTTLE BODIES

Chevrolet Performance has the right carburetor or throttle body to complete your new crate engine or give life to your rebuilt engine. Then, top off your engine with one of our great-looking air cleaners.

Carburetor – Holley 870-cfm



Part Number	Description	Technical Notes
19420445	Carburetor – Holley 770-cfm (not shown)	Holley 4150-style 770-cfm 4-bbl carburetor; Features show-car-quality polished finish; Dual feed, center-hung float bowls; Vacuum secondaries; Automatic electric choke; Quick-change adjustable vacuum secondary; Recommended for Small-Block and Big-Block engines; Bolts and gaskets included
19420446	Carburetor – Holley 850-cfm (not shown)	Holley 4150-style 850-cfm 4-bbl carburetor; Features show-car-quality polished finish; Mechanical secondaries; Electric choke; Four-corner idle adjustment; Power valve blowout protection; Custom-calibrated for the ZZ572/620 crate engine; Recommended for 502 crate engines and suitable for Big-Block engines; Bolts and gaskets included NOTE: Carburetor can only be recalibrated for use with other large-displacement engines.
19420447	Carburetor – Holley 870-cfm	Holley 4150-style 870-cfm 4-bbl carburetor; Features show-car-quality polished finish; Dual feed, center-hung float bowls; Vacuum secondaries; Automatic electric choke; Quick-change adjustable vacuum secondary; Recommended for 502 crate engines and suitable for Big-Block engines; Bolts and gaskets included
19410448	Carburetor – Holley Dominator 1150-cfm (not shown)	Dominator-style 1150-cfm 4-bbl carburetor; Features show-car-quality polished finish; Mechanical secondaries; Four-corner idle adjustment; Power valve blowout protection; Custom-calibrated for the ZZ572/720R crate engine; Bolts and gaskets included



Additional components required for installation. See chart above.



Parts intended for competition use only. See page 2 for details.



AIR CLEANERS



Air Cleaner – Chevrolet Logo High-Performance Design



Air Cleaner – Chevrolet Logo Classic Design



Air Cleaner Lid – Chevrolet High-Performance Design

Part Number	Description	Technical Notes
12342080	Air Cleaner – Chevrolet Logo High-Performance Design	14" round high-performance style air cleaner has chrome lid with embossed Chevrolet name; Fits most 4-bbl and 2-bbl carburetors; Will not fit Dominator-style carburetors; Bowtie nut not included NOTE: Check clearance between hood and top of air cleaner. Minimum clearance is 3.750" from top of carburetor gasket area to underside of hood.
12342071	Air Cleaner – Chevrolet Logo Classic Design	14" round classic-style air cleaner has chrome lid with embossed Chevrolet name and Bowtie attaching nut; Fits most 4-bbl and 2-bbl carburetors; Will not fit Dominator-style carburetors
19435167	Air Cleaner Lid – Chevrolet High-Performance Design	14" round spin-on design matches valve covers on ZZ632 Deluxe crate engine (page 186); Cast aluminum in Chevy Orange, with machined fins; Fits 4500-series (Dominator) carburetors and EFI throttle bodies; Lid only

SPARK PLUG WIRES

Chevrolet Performance spark plug wire kits are designed to fit your GM engine, eliminating the guesswork in selecting the correct length. These performance 8mm spark plug wires exhibit only 600 ohms per foot of resistance, with high noise suppression capabilities. Features include red wires with white Chevrolet insignia and black boots. Manufactured with double-wall silicone construction.



Spark Plug Wires – Chevrolet Bowtie Logo



Wire Loom Kit – Big-Block

Part Number	Description	Technical Notes
19433386	Chevrolet Bowtie Logo Wires	Kits include a 10" coil wire for engines, such as Ram Jet 350 and ZZ572 engines that have remote-coil HEI, plus 4 wire separators and HEI terminals and boots for the distributor cap; Custom-fit set designed to be used with black wire loom P/N 12495502
12495502	Wire Loom Kit – Big-Block	Used on late-model Big-Block trucks; Supplied with 1 left-hand support P/N 12553397, 1 right-hand support P/N 12553398, 3 four-wire retainers P/N 88891792, 2 three-wire retainers P/N 12163607, 2 two-wire retainers P/N 12132229, and 2 single-wire retainers P/N 12132228

ELECTRIC FUEL PUMPS AND COMPONENTS



Electric Fuel Pump



Camaro ZL1 Fuel Pump Module



Electric Fuel Pump – High-Output



Fuel Filter

Part Number	Description	Technical Notes
6472657	Electric Fuel Pump	For use on all carbureted engines; Flows 30–40 gph at 6–9 psi
19303293	Camaro ZL1 Fuel Pump Module	Production fuel pump module for the 2012 Camaro ZL1 with supercharged LSA engine; Supports approximately 600 horsepower; Direct replacement for 2010+ Camaro SS fuel pump modules; 250 liters per hour capacity at 65 psi; Pulse-width modulated, eliminates need for conventional pressure regulator; Kit includes fuel pump module/sender assembly tank seal and instruction sheet
25115899	Electric Fuel Pump – High-Output	Heavy-duty 12-volt electric rotary pump; Flows 72 gph at 6–8 psi
19245530	Fuel Pressure Regulator Kit (not shown)	Used on Ram Jet 502 crate engine; Fits other fuel-injected engines
854619	Fuel Filter	High-capacity in-line filter; Suitable for all high-performance carbureted applications; 3/8" inlet and outlet

FACTORY PERFORMANCE™ PARTS

SPECIALTY AUTO PARTS U.S.A. INC.

AN AUTHORIZED CHEVROLET PERFORMANCE™ LICENSEE



CHEVROLET

Performance

Vehicles / Parts / Racing

Official Licensed Product



Chevrolet Performance Licensed Parts

Chevrolet Performance Licensed Parts

Slant-Edge Big-Block Chevrolet Valve Covers

It's time to give your Big-Block Chevy a long overdue engine makeover. The new Slant-Edge look for big-block is the perfect way to customize your engine so that it turns heads when you pop the hood at your local car show! With 13 finish and Bowtie emblem combinations there's something for everyone, and the best part is that these valve covers can be complemented with a matching Slant-Edge air cleaner, and breather caps to finish off the look in a perfectly coordinated way. There are three emblems to choose from: raised with a CNC machined finish, recessed and hand painted, blackfield recessed and raised, and lastly a completely new redfield recessed raised. These premium die-cast aluminum valve covers have been optimized for maximum internal clearance and feature special bolts on the intake side so you don't have to struggle in tight places. Each valve cover includes a baffle and rubber grommets. Sold in pairs. Patent Pending.

Features:

- Available in 13 Different Styles
- Tall Style Design, Clears Most Aftermarket Valvetrains
- Fits Mark IV, Big Block (396-454) Engines 1965 to 1996
- Officially Licensed Chevrolet Performance Product
- Includes Baffles, Breather Grommet & PVC Grommet
- Sold as a Pair



141-879.....Chrome;
Raised Emblem on Recessed
Blackfield



141-868.....Liquid Black;
Raised/Milled Emblem



141-871.....Chevy Orange;
Raised/Milled Emblem

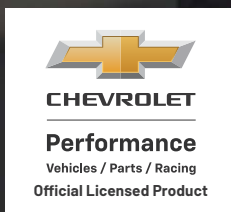

Scan QR codes
for more info!



141-873.....Red;
Raised/Milled Emblem



141-867.....Black Crinkle;
Raised Emblem on Recessed Redfield



141-876.....Black Crinkle;
Recessed Red Emblem



141-878.....Polished;
Raised Emblem on Recessed Blackfield



141-872.....Cast Gray Crinkle;
Raised/Milled Emblem



141-874.....Polished;
No Emblem



141-870.....Black Crinkle;
Raised/Milled Emblem



141-877.....Chrome;
Recessed Red & Black Emblem



141-869.....Powdercoat Ready;
Raised Emblem



141-875.....Polished;
Recessed Red & Black Emblem

SLANT-EDGE DRESS-UP PARTS

SLANT-EDGE VALVE COVERS



P/N: 141-265



P/N: 141-256

GM LS Engines LS1-LS7

LS Slant-Edge Valve Covers are available in eight different looks. Choose from multiple finishes and emblem configurations to fit your taste and styles. LS Slant-Edge Valve Covers are also supplied with mounting hardware and an oil filler cap. Sold in pairs. Can accommodate coil relocation brackets (P/N 69520 and 69521). U.S. Pat. D657,798.



P/N: 141-840



P/N: 141-844

Small-Block Gen II Valve Covers

These valve covers have generous internal clearance for larger valve train setups, and come in one of five finishes, with the Bowtie & CHEVROLET Emblem. Tall-style, with removable baffle. Includes grommets and mounting bolts. Sold in pairs. U.S. Pat. D727,362.



P/N: 141-922



P/N: 141-931

Small-Block Gen I Valve Covers

These premium valve covers showcase the iconic Bowtie & CHEVROLET Emblem across one of 16 styles. They also allow more internal clearance than stock covers. Equipped with grommets for air breather and PCV, unless otherwise specified. Sold in pairs. U.S. Pat. D580,954.



P/N: 141-836



P/N: 141-834



P/N: 141-835

Slant-Edge Air Cleaner Kits

These mighty air cleaners will bring head-turning fashion to your engine bay! The air cleaner's base is recessed for a low-profile appearance, maximum performance, and hood clearance. They are supplied with genuine three-inch GM air filters for maximum airflow, and supplied with necessary mounting hardware. US Pat D813,274.



P/N: 141-856



P/N: 141-860



CHEVROLET

Performance

Vehicles / Parts / Racing
Official Licensed Product

Slant-Edge Breather Caps

Continuing the tradition of the hottest design in engine dress-up today, Slant-Edge Breather Caps are not only functional, but also showcase the iconic Chevrolet Bowtie in vivid 3D. Choose from thirteen styles, and add a small touch of added cool under your hood. US Pat D905,114.



CLASSIC-STYLE DRESS-UP PARTS

Valve Covers

Flaunt your Bowtie style with these gorgeous dress-up valve covers. Manufactured from die-cast aluminum or heavy-gauge stamped steel, they are tall-style, or for select P/N's, production height (short). Oil-restricting baffles are included with most valve covers, as well as rubber grommets for PCV and breather caps.

Small-Block Gen I Valve Covers

Chevrolet Small-Block 262 to 400 Engines (1959-1986)



P/N: 141-881

P/N: 141-117

Small-Block Gen II Center Bolt Valve Covers

Chevrolet Small-Block 305-350 Engines (1987-Pre-LS)



P/N: 141-105

P/N: 141-131

Big-Block Mark IV, Gen V/VI Valve Covers

Chevrolet Big-Block 396-454 Engines (1965-1996)



P/N: 141-142

P/N: 141-787

Black Crinkle Bowtie Differential Covers

Reduce deflection under heavy torque loads with cast-aluminum Bowtie Emblem Differential Covers. These reinforced differential covers look great and enhance undercar appearance. The Bowtie emblem is prominently displayed with a precision CNC-milled finish. Each cover includes two adjustable bolts to stabilize bearing main caps; fluid capacity and magnetic drain plugs; and mounting bolts.



P/N: 141-696

P/N: 141-697



The Most Authentic and Accurate Parts For Your Restoration

It was a chance find, based on a story recounted by a friend of a friend. But there it was—the classic muscle car you'd been searching for, hidden beneath a dusty tarp in an old barn. You worked hard and finally convinced the stubborn farmer to sell it.

With the car safely in your garage, the thrill of the hunt morphs into the realization that a careful and accurate restoration is needed to bring that vintage car back to its original glory. That means hunting for the right parts—everything from the carburetor to the clamps that hold the fuel lines in place.

GM knows it's the little things that count with a restoration. With countless resources for restoration components, assurance that you're getting the most authentic and best-fitting parts comes when you buy officially licensed GM Restoration Parts. They're made by manufacturers who have been accepted into the GM Restoration licensing program and they have identified licensed items by using the GM Restoration logo; Some even use original tooling to reproduce the look, feel, and performance.

You can find licensed GM Restoration Parts for everything from the grille badge for a 1969 Camaro to the body shell itself for that Camaro. That's right – an entire classic Camaro body!

Before purchasing any reproduction parts for your valuable project, make sure the manufacturer is licensed by GM Restoration Parts. With mint condition on your mind, licensed GM Restoration Parts are the only parts that should go into your barn-find beauty.

GM Restoration Parts – Licensed Manufacturers

Company	Phone	Website
BELTS AND HOSES		
Ground Up Restorations, Inc.	(203) 235-1200	ss396.com
Quanta Products, LLC	(410) 658-5700	quantaproducts.com
Shafer's Classic Reproductions, Inc.	(813) 628-0092	shafersclassic.com
BODY PARTS		
Auto Metal Direct	(770) 967-0909	autometaldirect.com
Dynacorn International, Inc.	(805) 987-8818	dynacorn.com
Fit-Rite Auto Body Parts Inc.	(800) 992-1064	keypartsonline.com
Golden Star Corporation	(972) 315-3758	goldenstarauto.com
Mack Hills, Inc.	(660) 263-8948	mack-products.com
Mar-K Specialized Manufacturing, Inc.	(405) 721-7945	mar-k.com
Triplus Co. Ltd.	011-886-2-27557686	triplus.com.tw
BODY SHELL		
B-Rod or Custom	(865) 281-8821	b-rodorcustom.com
Five Star Fabricating, Inc.	(262) 877-2171	fivestarbodies.com
Dynacorn Classic Bodies, Inc.	(805) 987-8818	dynacornclassicbodies.com
Race Car Replicas	(586) 329-1573	race-car-replicas.com
Superformance	(949) 900-1951	superformance.com
BUICK		
Bob's Automobilia	(805) 434-2963	bobsautomobilia.com
CARS, Inc.	(908) 369-3666	oldbuickparts.com
Highway Stars, Inc.	(847) 599-1600	highwaystars.net
CADILLAC		
Beaulin Enterprises, Inc.	(913) 772-0707	mcveys.com
CHEVROLET		
Ausley's (J'Leys and Co.)	(336) 228-6701	chevelle.com
Autocraft Investments, Inc., d/b/a (NPD)	(352) 861-5701	npdlink.com
CromCo	(626) 282-8381	genesmithparts.com
CHQ Reproductions	(800) 441-3866	classichq.com
Clark's Corvair Parts, Inc.	(413) 625-9092	corvair.com
Classic Industries Inc d/b/a OER	(800) 955-1511	OERPARTS.com
D&R Classic Automotive, Inc.	(800) 472-6952	drclassic.com
Danchuk Manufacturing, Inc.	(714) 540-4363	danchuk.com
El Camino Manufacturing, Inc.	(360) 417-9201	elcaminomanufacturing.com
Hubbard's Impala Parts, Inc.	(336) 227-1589	impalaparts.com
I&I Reproductions, Inc.	(652) 531-7904	iandireproduction.com
Jim Carter's Antique Truck Parts	(816) 833-1913	oldchevytrucks.com
KNS Accessories/ Grand General Accessories	(310) 631-2589	knsacc.com
Muscle Factory	(714) 223-0745	muscle-factory.com
Original Parts Group, Inc.	(800) 243-8355	opgi.com
Rinehold dba Bob's Antique Auto Parts	(310) 515-1089	bobsantiques.com
United Pacific Industries, Inc.	(866) 327-5288	uapac.com
Vintage, Inc.	(714) 634-1932	vintageinc.com
CORVETTE		
AFCO Performance Group	(800) 632-2320	afcoperformancegroup.com
American Custom Industries (Bobbart)	(419) 882-2091	acivette.com
Auto Accessories of America	(877) 422-2347	topflightautomotive.com
Auto Pro USA, Inc.	(310) 637-4500	autoprousa.com
CC Industries, LLC, d/b/a Corvette Central	(800) 345-4122	corvettecentral.com
Corvette Specialties Manufacturing	(760) 568-6450	grilletooth.com
Corvette Stainless Steel Brakes aka C.S.S.B., Inc.	(352) 554-5470	cssbinc.com
EC Products Design	(805) 466-4703	ecproducts.com
Eckler Industries, LLC	(218) 272-5239	ecklerscorvette.com
Just Corvette	(636) 947-6060	justcorvettes.com
Keen Parts, Inc.	(513) 353-3449	keenparts.com
Melrose T-Top International	(815) 758-2783	melroset-tops.com
Zip Products Inc.	(800) 962-9632	zip-corvette.com
COPO PARTS		
Turn Key Automotive	(248) 628-5556	copopartsdirect.com

Company	Phone	Website
EMBLEMS / LENSES / DECALS / TRIM		
Bill's Birds, Inc.	(631) 667-3853	
Counterpart Automotive, Inc.	(800) 235-2470	truckandcarshop.com
ECS Automotive Concepts, LLC	(636) 751-4220	ecsautomotive.com
GT Performance Products	(818) 847-9611	gtperformanceproducts.com
Horsepower	(270) 782-2900	holley.com
Legendary Auto Interiors, Ltd.	(800) 363-8804	legendaryautointeriors.com
Millenium Industries, Inc.	(708) 895-1381	
Mutton Hollow Chevys, LLC	(801) 546-3274	muttonhollowchevys.com
Phoenix Graphix, Inc.	(800) 941-4550	phoenixgraphix.com
Proline Restoration	(678) 887-6750	prolinerestorationparts.com
Specialty Reproductions	(515) 314-7015	
Stencils and Stripes Unlimited Inc.	(847) 692-6893	stencilsandstripes.com
The Parts Place	(630) 365-1800	thepartsplaceinc.com
Trim Parts, Inc.	(513) 934-0815	trimparts.com
Wolverine Diecast Corp.	(586) 757-1900	
Year One, Inc.	(706) 658-2140	yearone.com
GLASS		
Pilkington North America, Inc.	(800) 848-1351	pilkington.com
HARD / MECHANICAL PARTS		
Custom Autosound	(714) 773-1423	casmg.com
Forever Sharp Products, Inc.	(888) 878-2156	foreversharp.com
Cablecraft ISS, LLC	(503) 802-1301	instrumentsales.com
Jim Carter's Antique Truck Parts	(816) 833-1913	oldchevytrucks.com
K&B Special Products	(770) 771-1031	
Nunbeter Reproductions	(405) 364-0416	
Steele Rubber Products, Inc.	(704) 483-9343	steelerubber.com
Tedd Cycle, Inc.	(845) 565-2806	Vtwinmfg.com
The Right Stuff	(800) 405-2000	getdiscbrakes.com
OLDSMOBILE		
Fusick Automotive Products, Inc.	(860) 623-1589	fusickautomotiveproducts.com
Thornton Reproductions, LLC	(610) 282-2494	thorntonmusclecars.com
PONTIAC		
Leader Industries Inc., d/b/a The Fiero Store	(860) 645-1933	leaderind.com
Max Performance	(267) 638-0355	maxperformanceinc.com
Ames Performance Engineering	(800) 421-2637	amesperf.com
Late Model Reproductions, Inc.	(864) 855-2694	hawksmotorsports.com
WHEELS PARTS		
Hubcap Kingdom, LLC	(918) 622-2277	hubcapkingdom.com
Jenica Inc, d/b/a Excalibur Wheel Accessories	(909) 923-8300	excaliburwheel.com
Quality Lapel Pins	(303) 979-9103	qualitylapelpins.com
Revolution Supply Co. Inc.	(714) 891-0100	coyoteaccessories.com
Roadster Wheels, LLC	(423) 648-8501	roadsterwirewheel.com
MISC.		
Gardner-Westcott Co.	(800) 521-9805	gardner-westcott.com
G & S Sales, Inc.	(214) 930-5969	
Kaba Ilco	(800) 334-1381	ilco.us
Lectric Limited Inc.	(708) 563-0400	lectriclimited.com
PUI Interiors	(800) 342-0610	PUIinteriors.com
QuietRide Solutions	(209) 942-4777	quietride.com
Retro Manufacturing, LLC	(702) 483-2222	classiccarrstereos.com
Strattec	(414) 247-3333	strattec.com
Undercover Innovations	(661) 325-4506	undercoverinnovations.com
GAUGES		
AutoMeter	(815) 895-8141	autometer.com
ENGINE DRESS-UP KIT		
Ansen Enterprises, Inc.	(310) 534-1837	ansenus.com
Billet Specialties	(708) 588-0505	billetspecialties.com
Coffman Corvette	(419) 522-2246	coffmancorvette.com
Holley Performance	(270) 782-2900	holley.com
PML Inc.	(310) 671-4345	yourcovers.com
Specialty Auto Parts U.S.A.	(276) 666-3000	performanceparts.com

Get The OER[®] Advantage. . . It's Almost Unfair!

Authentic Quality Reproduction Parts for Classic American Muscle Cars and Trucks

ORIGINAL QUALITY • ORIGINAL APPEARANCE



Original Fit

Appearance is extremely important in reproduction parts, but just as important is the way the part fits. You will appreciate OER[®] reproductions. Parts are designed to fit as closely to the original as possible. Each part is checked and rechecked to ensure proper fit and function.

Superior Quality

It's one thing to manufacture a reproduction part, it's another to duplicate the quality. OER[®] uses the finest quality materials and workmanship to ensure the finished part meets or exceeds original equipment specifications. In fact, many OER[®] products are superior to the original.

Authentic Appearance

Each OER[®] part is manufactured to original specifications, down to the smallest detail. Consistent quality control methods ensure an exact duplicate every time.

OER[®] Officially Licensed Products

Many OER[®] products are officially licensed by the original manufacturers assuring the highest quality reproductions available.



OER ORIGINAL EQUIPMENT REPRODUCTION

Manufacturing Authentic Products for The Restoration Industry

Learn more about OER online: www.oerparts.com

Ask for OER[®] at your local restoration parts supplier or any participating GM dealer

Chevrolet Performance Authorized Centers

ALABAMA

Company Name	Contact Name	Address	City	Zip	Phone	Website	Email Address
Edwards Chevrolet	Wayne Myers	1400 Third Ave N	Birmingham	35203	205.716.3301	downtown.chevyman.com	wmyers@chevyman.com

ALASKA

Company Name	Contact Name	Address	City	Zip	Phone	Website	Email Address
Swickard Chevrolet Buick GMC of Anchorage	Melissa Adams	1300 E Fifth Ave	Anchorage	99501	907.279.9641	swickardanchorage.com	melissa.adams@swickard.com

ARIZONA

Company Name	Contact Name	Address	City	Zip	Phone	Website	Email Address
Autonation Chevrolet Gilbert	Brad England	1150 S. Gilbert Rd Bldg B	Chandler	85286	480.369.4289	autonationchevroletgilbert.com	englandb@autonation.com
Courtesy Chevrolet	Ron Kiepe	1233 E Camelback Rd	Phoenix	85014	602.604.3003	courtesychev.com	rkiepe@courtesychev.com
Midway Chevrolet	Casey Dahmen	2323 W Bell Rd	Phoenix	85023	602.791.3243	midwaychevy.com	cdahmen@vtaig.com
Sands Motor Company	Gary Dewees	5418 NW Grand Ave	Glendale	85301	623.842.5212	sandsglendale.com	gdewees@sandsautomotivegroup.com
Watson Chevrolet, Inc	Mark Catanzaro	625 W Auto Mall Dr	Tucson	85705	520.292.1500	watsonchevrolet.com	markc@watsonchevrolet.com

CALIFORNIA

Company Name	Contact Name	Address	City	Zip	Phone	Website	Email Address
American Chevrolet	Joe Borges	4742 McHenry Ave	Modesto	95356	209.606.6481	americanchevrolet.com	jborges@americanchevrolet.com
AV Chevrolet	Miguel Romo	1160 Motor Lane	Lancaster	93534	661.675.6155	avchevy.com	miguel@avchevy.com
Courtesy Chevrolet Center	Robert Medina	750 Camino Del Rio N	San Diego	92108	619.450.8050	courtesysandiego.com	rmedina@courtesysd.com
Cumming Chevrolet	Marco Guerrero	2301 National City Blvd	National City	91950	619.477.2163	cummingchevrolet.com	will@cummingchevy.com
Diamond Buick GMC Palmdale	Brenden Herem	39012 Carriage Way	Palmdale	93551	661.274.7009	driveadiamond.com	bherem@daliaauto.com
Dublin Chevrolet Cadillac	Hector Alvarado	4200 John Monego Court	Dublin	94568	925.479.3544	dublinchevrolet.com	hectora@cacargroup.com
FH Dailey Chevrolet	Floyd Amerino	800 Davis Street	San Leandro	94577	800-4A-GMPART	fhdaily.com	floyd.amerino@fhdaily.com
Guaranty Chevrolet Motors, Inc	Carl Lutes	711 E 17th Street	Santa Ana	92701	714.973.1711	occhevy.com	clutes@occhevy.com
Maita Motorsports	Art Wong	9650 Auto Center Dr	Elk Grove	95757	916.825.5562	maitamotorsports.com	artwong@maita.net
Mark Christopher Auto Center	Doug Reeves	2131 Convention Center Way	Ontario	91764	909.390.2920	markchristopher.com	dreeves@markchristopher.com
Paradise Chevrolet	Rene Medina	6350 Leland St	Ventura	93003	805.642.0134	paradisechevrolet.com	rmedina@paradisechevrolet.com
Paradise Chevrolet Cadillac	Marcus McConnell	27360 Ynez Road	Temecula	92591	951.662.6227	paradiseautos.com	mmcconnell@paradiseautos.com
Roseville Chevrolet	DC Sarra	350 Automall Dr	Roseville	95661	916.945.9142	myrosevillechevrolet.com	dsarra@myrosevillechevrolet.com

COLORADO

Company Name	Contact Name	Address	City	Zip	Phone	Website	Email Address
John Elway Chevrolet	Ken Casey Jr.	5200 S Broadway	Englewood	80113	800.345.5744	johnelwaychevrolet.com	kcasey@elwaydealers.net

FLORIDA

Company Name	Contact Name	Address	City	Zip	Phone	Website	Email Address
Autonation Chevrolet South Clearwater	James Kubisiak	15005 US Hwy 19 N	Clearwater	33764	813.267.4257	autonationchevroletclearwater.com	kubisiakj@autonation.com
Grieco Chevrolet of Lauderhill	Emilio Rodriguez	1640 N. State Rd #7 (441)	Lauderhill	33313	786.444.4396	griecochevroletlauderhill.com	erodriguezjr@griecocars.com
Jon Hall Chevrolet, Inc	Tom Brammer	551 N Nova Road	Daytona Beach	32114	386.236.4557	jonhall.com	tom.brammer@jonhall.com
Sandy Sansing Chevrolet, Inc	Scott Clanton	6200 Pensacola Blvd	Pensacola	32505	850.748.0111	sandysansingchevrolet.com	clantons@sandysansing.com
Stingray Chevrolet	Aaron Springer Mikie Garcia	2002 N Frontage Rd	Plant City	33563	813.359.5466 813.359.5060	stingraychevrolet.com	aspringer@stingraychevrolet.com mgarcia@stingraychevrolet.com
Victory Layne Chevrolet	Dave Marlet	3980 Fowler Street	Fort Myers	33901	239.936.8561	victorylaynechevrolet.com	davemarlet@victorylaynechevy.com

GEORGIA

Company Name	Contact Name	Address	City	Zip	Phone	Website	Email Address
John Thornton Chevrolet	Gary Ellis	1971 Thornton Rd	Lithia Springs	30122	770.841.2344	johnthornton.com	gellis@johnthornton.com
Nash Chevrolet Co	George Pittman	630 Scenic Hwy S	Lawrenceville	30046	770.963.9266x1141	nashchevy.com	gpittman@nashchevy.com
Vaden Chevrolet Savannah	Rick Freeman	1010 Lynes Ave	Savannah	31415	833.823.3678	danvadenchevrolet.com	vadenpt@danvaden.com

CHEVROLET PERFORMANCE AUTHORIZED CENTERS

IDAHO

Company Name	Contact Name	Address	City	Zip	Phone	Website	Email Address
Kendall Chevrolet Buick GMC of Nampa	Alex Gilmore	15700 Idaho Center Blvd	Nampa	83687	208.249.3712	kendallautomall.com	alexgilmore@kendallauto.com

ILLINOIS

Company Name	Contact Name	Address	City	Zip	Phone	Website	Email Address
Ed Morse Chevrolet Buick GMC	Shaun Utz	1450 W Market St	Red Bud	62278	618.282.2353	edmorseparts.com	shaunutz@edmorse.com
Hawk Chevrolet of Joliet	James Huff	1527 Mound Rd	Rockdale	60436	815.214.9907	hawkchevy.com	jhuff@hawkauto.com
Uftring Weston Chevrolet	Bob Humphrey	1600 W War Memorial Dr	Peoria	61614	309.686.2500	uftringweston.com	bobhumphrey@uftringweston.com
Zeigler Chevrolet-Schaumburg, LLC	John Horton	1230 E Golf Rd	Schaumburg	60173	847.407.9068	zeiglerchevroletschaumburg.com	johnhorton@zeigler.com

INDIANA

Company Name	Contact Name	Address	City	Zip	Phone	Website	Email Address
Hubler Chevrolet	Chris Mosena	8220 S US 31	Indianapolis	46227	317.730.3700	hublerchevyauto.com	cmosena@drivehubler.com

IOWA

Company Name	Contact Name	Address	City	Zip	Phone	Website	Email Address
Karl Kustoms	Adam Moore	5927 NE Industry Dr	Des Moines	50313	855.806.1147	karlkustoms.com	adam@karlkustoms.com
Rydell Chevrolet	Brian Tenley	1325 E San Marnan Dr	Waterloo	50702	319.234.4601	rydellauto.com	brian@rydellauto.com
Shottenkirk Inc	Aaron Fedler	1722 53rd Street	Fort Madison	52627	877.310.0513	shottenkirkfortmadison.com	afedler@shottenkirk.com

KANSAS

Company Name	Contact Name	Address	City	Zip	Phone	Website	Email Address
Hendrick Chevrolet Shawnee Mission	Jeff Kopp	8300 Shawnee Mission Pkwy	Merriam	66202	913.384.1550	chevyusa.com	jeff.kopp@hendrickauto.com

KENTUCKY

Company Name	Contact Name	Address	City	Zip	Phone	Website	Email Address
Bachman Auto Group, Inc	Kendall Dick	9650 Bluegrass Pkwy	Louisville	40299	502.719.3857	bachmanautogroup.com	kendall@bachmanautogroup.com
Bob Hook Chevrolet, Inc	Phil Friedel	4144 Bardstown Rd	Louisville	40218	502.499.8060	bobhookparts.com	pfriedel@bobhook.net

LOUISIANA

Company Name	Contact Name	Address	City	Zip	Phone	Website	Email Address
Red River Chevrolet	John Wieclaw	221 Traffic St	Bossier City	71111	318.549.7505	redriverchevy.com	jwieclaw@redriverchevy.com

MAINE

Company Name	Contact Name	Address	City	Zip	Phone	Website	Email Address
Quirk Auto Parts	Richie Lynch	293 Hogan Rd	Bangor	04401	800.664.6008	quirkchevyofbangor.com	rlynch@quirkauto.com

MARYLAND

Company Name	Contact Name	Address	City	Zip	Phone	Website	Email Address
Criswell Chevrolet, Inc	Andrew Martin	503 Quince Orchard Rd	Gaithersburg	20878	301.212.4444	criswellchevrolet.com	amartin@criswellauto.com
Jerry's Chevrolet	Robyn Miller	1940 E Joppa Rd	Baltimore	21234	410.215.9205	jerryschevrolet.com	rmiller@jerrysautogroup.com
Ourisman Chevrolet of Rockville	Fredy Calderon	15301 Frederick Road	Rockville	20855	240.705.3263	rockvillechevrolet.com	fcalderon@ourismancars.com

MICHIGAN

Company Name	Contact Name	Address	City	Zip	Phone	Website	Email Address
Berger Chevrolet, Inc	Kevin Palmbo	2525 28th St SE	Grand Rapids	49512	800.878.2121	bergerwholesaleparts.com	parts@bergerchevy.com
Ed Rinke Chevrolet	Derek Miller	26125 Van Dyke	Center Line	48015	586.497.4100	edrinkeperformance.com	dmiller@edrinke.com
Lafontaine Performance Center	Marcus Montague	2800 N Milford Road	Highland	48357	248.714.1519	lafontaineperformancecenter.com	mmontague@lafontaine.com
Shaheen Chevrolet, Inc	Daniel Earley	3901 S MLK Jr Blvd	Lansing	48910	800.452.2828	shaheenchevrolet.com	dearley@shaheenparts.com

MINNESOTA

Company Name	Contact Name	Address	City	Zip	Phone	Website	Email Address
Suburban Chevrolet	Steve Sutton	5700 Lincoln Dr	Edina	55436	952.952.5497	suburbangmparts.com	ssutton@suburbanchev.com

MISSISSIPPI

Company Name	Contact Name	Address	City	Zip	Phone	Website	Email Address
Rogers-Dabbs Chevrolet, Inc	Benny Hopkins	1501 W Government St	Brandon	39042	601.398.5592	rdc123.com	bennyhopkins65@gmail.com

MISSOURI

Company Name	Contact Name	Address	City	Zip	Phone	Website	Email Address
Cable-Dahmer Chevrolet, Inc	Kevin Berry	1834 S Noland Rd	Independence	64055	660.726.2558	cabledahmerind.com	kwberry@cabledahmer.com
Bob McCosh Chevrolet Buick GMC Cadillac	Rick Neuner	#1 Business Loop 70	Columbia	65203	573.442.6156	bobmccosh.com	rneuner@bmcmail.com

NEBRASKA

Company Name	Contact Name	Address	City	Zip	Phone	Website	Email Address
Friesen's Chevrolet, Inc	Al Walters	806 S Way Ave	Sutton	68979	402.630.4894	friesenperformanceracing.com	al.walters@friesenauto.com

NEVADA

Company Name	Contact Name	Address	City	Zip	Phone	Website	Email Address
Fairway Chevrolet	Jason Koontz	3100 E Sahara Ave	Las Vegas	89104	702.641.1678	fairwaychevy.com	parts@fairwaychevy.com

NEW MEXICO

Company Name	Contact Name	Address	City	Zip	Phone	Website	Email Address
Quality GMC Buick, Inc	Garry Ricci	7901 Lomas Blvd NE	Albuquerque	87110	505.348.1103	qualitybydilorenzo.com	garryr@qualitydeal.com

NEW JERSEY

Company Name	Contact Name	Address	City	Zip	Phone	Website	Email Address
Barlow Chevrolet/Med Duty	Paul Seay	6057 Rt 130 S	Delran	08075	856.461.8400	barlowchevrolet.com	pseay@barlowautogroup.com

NEW YORK

Company Name	Contact Name	Address	City	Zip	Phone	Website	Email Address
Eagle Chevrolet of Riverhead	Jesse Bullwinkle	1330 Old Country Rd	Riverhead	11901	631.727.1900	eaglechevy.com	jesseb@eagleautomall.com
Mangino Chevrolet, Inc	Brian Greene	4447 St Hwy 30	Amsterdam	12010	518.889.5218	manginochevy.com	bgreene@mangino.com
Mount Kisco Chevrolet	Richard Bastardi	175 N Bedford Rd	Mount Kisco	10549	914.232.7737	mtkiscochevrolet.com	wholesaleparts@mtkiscochevrolet.com

NORTH CAROLINA

Company Name	Contact Name	Address	City	Zip	Phone	Website	Email Address
Everett Chevrolet Buick GMC Cadillac	Kim Dowell	161 Hwy 70 SE	Hickory	28602	828.322.2100 877.369.1645	everettchevy.com	kdowell@everettchevy.com
Modern Chevrolet, LLC	Randy Stanley	5955 University Pkwy	Winston-Salem	27105	888.732.6545	modernchevy.com	rstanley@modernauto.com
Rick Hendrick City Chevrolet	Darrell Langford	5101 E Independence Blvd	Charlotte	28212	704.566.7460	citychevrolet.com	darrell.langford@hendrickauto.com
Terry Labonte Chevrolet	Sandy Schulman	1401 Bridford Pkwy	Greensboro	27407	336.335.1286	terrylabontechevy.com	sandy.schulman@hendrickauto.com

NORTH DAKOTA

Company Name	Contact Name	Address	City	Zip	Phone	Website	Email Address
Rydell Chevrolet Buick GMC Cadillac	Fred Van Heste II	2700 S Washington	Grand Forks	58201	701.757.5955	rydellcars.com	fvanheste@rydellcars.com

OHIO

Company Name	Contact Name	Address	City	Zip	Phone	Website	Email Address
#1 Cochran Buick GMC	Austin Carothers	7977 Market Street	Youngstown	44512	330.726.2277	cochrancars.com	austin.carothers@cochran.com
Classic Chevrolet	Cliff Murphy	6877 Center St	Mentor	44060	440.205.6319	driveclassicchevy.com	cmurphy@driveclassic.com
Coughlin Chevrolet Buick Cadillac of Marysville	Brian Dixon	15801 US Rte 36	Marysville	43040	740.513.7033	coughlinmarysvillegm.com	briandixon@coughlincars.com

OKLAHOMA

Company Name	Contact Name	Address	City	Zip	Phone	Website	Email Address
Bob Howard PDC	Bruce Hoppe	3501 North Santa Fe	Oklahoma City	73118	405.525.4456	bobhowardpdc.com	bhoppe@bobhowardauto.com

OREGON

Company Name	Contact Name	Address	City	Zip	Phone	Website	Email Address
Buick GMC of Beaverton	Matt Briscoe	9155 SW Canyon Rd	Portland	97225	503.291.9347	beavertongmc.com	mbriscoe@lithia.com
Ron Tonkin Chevrolet	Kurt Gross	122 NE 122nd Ave	Portland	97230	503.546.6701	tonkinchevrolet.com	kgross@tonkin.com

PENNSYLVANIA

Company Name	Contact Name	Address	City	Zip	Phone	Website	Email Address
Bowser Buick	Mike Mervis	1001 Clairton Blvd	Pleasant Hills	15236	412.469.2100	powerofbowser.com	parts@powerofbowser.com
Fred Beans Parts	Dave Wittlinger	131 Doyle St	Doylestown	18901	877.385.5769	fbparts.com	dwittlinger@fredbeans.com
Rohrich Cadillac	James Pugliese	2116 W Liberty Ave	Pittsburgh	15226	412.527.9882	rohrichparts.com	jpugliese@rohrich.com

RHODE ISLAND

Company Name	Contact Name	Address	City	Zip	Phone	Website	Email Address
Tasca Chevrolet	Mark Grivers	114 Fortin Dr	Woonsocket	02895	401.769.3000	tascachevy.com	mgrivers@tasca.com

SOUTH CAROLINA

Company Name	Contact Name	Address	City	Zip	Phone	Website	Email Address
Raceway Chevrolet	Debbie Fluet	1111 S 5th St	Harsville	29550	843.639.1989	racewayautomotive.com	thaynes@newsomeparts.com

TENNESSEE

Company Name	Contact Name	Address	City	Zip	Phone	Website	Email Address
AutoNation GMC Mendenhall	Jeff Sappington	2621 S Mendenhall Road	Memphis	38115	901.209.1262	autonationgcmcmemphis.com	sappingtonj@autonation.com
Freeland Chevrolet	Louis Norris	5333 Hickory Hollow Pky	Antioch	37013	615.731.3000	freelandchevrolet.com	louis.norris@freelandauto.com
James Corlew Chevrolet	Logan Milliken	722 College St	Clarksville	37040	931.552.2020	jamescorlewautomotive.com	loganmilliken@jamescorlew.com

TEXAS

Company Name	Contact Name	Address	City	Zip	Phone	Website	Email Address
Autonation Chevrolet Gulf Freeway	Jimmy Beltran	13800 Gulf Fwy	Houston	77034	512.585.1711	autonationchevroletgulffreeway.com	beltranj@autonation.com
Autonation Chevrolet North Richland	Jennifer Solis	7769 Grapevine Hwy	North Richland Hills	76180	800.792.8743	autonationchevroletnorthrichlandhills.com	solisj@autonation.com
Bruce Lowrie Chevrolet, Inc	Barry Butler	711 SW Loop 820	Fort Worth	76134	817.293.3299	brucelowriechevrolet.com	toby@brucelowrie.com
Classic Chevrolet, Inc	Rick Johnston	2501 William D Tate	Grapevine	76051	800.259.1200	nationaloemparts.com	rjohnston@classicchevrolet.com
Classic Chevrolet of Houston	Steve Teigland	7000 SW Fwy	Houston	77074	972.822.9865	classicchevycentral.com	steigland@classicofhouston.com
Classic Chevrolet Sugar Land	Richard Battles	13115 SW Freeway 90A	Sugar Land	77478	713.449.6860	classicchevysugarland.com	rbattles@classicelite.com
Covert Buick GMC	John Raygo	11750 Research Blvd	Austin	78759	512.583.3211	covertbuickgmc.com	johnraygo@covertauto.com
Don Hewlett Chevrolet-Buick, Inc	Jeff Gilbert	200 Commerce Blvd	Georgetown	78626	512.681.3054	donhewlett.com	jeffg@donhewlett.com
Freedom Chevrolet Buick GMC by Ed Mo	Jorge Flores	8008 Marvin D Love Fwy	Dallas	75237	972.427.4020	parts.freedomchevydallas.com	performanceparts@freedomchevydallas.com
Henna Chevrolet, L.P.	Mika Carney	8805 IH-35 N	Austin	78753	512.832.2330	henna.com	mika.carney@henna.com
Northside Chevrolet	Mike Martin	9400 San Pedro Ave	San Antonio	78216	210.341.3311	mynschevy.com	mmartin@mynschevy.com
Scoggin Dickey Chevrolet Buick	Jesse Smith	5901 Spur 327	Lubbock	79424	806.456.0211	sdparts.com	jsmith@sdparts.com

UTAH

Company Name	Contact Name	Address	City	Zip	Phone	Website	Email Address
Larry H. Miller Chevrolet	Whitley Day	5500 S State St	Murray	84107	801.264.3333	larryhmillerchevrolet.com	wday@lhauto.com
Young Chevrolet/Hertz	Guy Mia	645 N Main	Layton	84041	801.544.1835	youngchev.com	guy.miya@youngchev.com

VIRGINIA

Company Name	Contact Name	Address	City	Zip	Phone	Website	Email Address
Radley Chevrolet	Christopher Rogers	11301 Patriot Hwy	Fredericksburg	22408	540.376.3685	radleychevrolet.com	chrisrogers@radleyautogroup.com

WASHINGTON

Company Name	Contact Name	Address	City	Zip	Phone	Website	Email Address
Camp Chevrolet	Zak Deason	101 E Montgomery Ave	Spokane	99207	888.270.8461	campchevrolet.com	zakdeason@lithia.com
Jet Chevrolet	Steve Haase	35700 Enchanted Pky S	Federal Way	98003	800.257.6655	jetchevrolet.com	jetparts@dinsmoreautogroup.com

WISCONSIN

Company Name	Contact Name	Address	City	Zip	Phone	Website	Email Address
Bergstrom Automotive - Green Bay	Corey Miller	2700 S Ashland Ave	Green Bay	54304	920.496.3251	broadwaychev.com	corey.miller@bergstromauto.com
Holz Motors, Inc	Chad Kallies	5961 S 108 Pl	Hales Corners	53130	414.209.1300	holzmotors.com	ckallies@holzmotors.com
Gandrud Chevrolet, Inc	Chris "Mac" Wilkymack	919 Auto Plaza	Green Bay	54302	888.284.7491	gmperformancemotor.com	performance@gandrud.com



OE

GOLD

SILVER

OPTIMUM OUTPUT REQUIRES OPTIMUM PARTS



Professional driver on a closed course. Do not attempt.

No matter what you drive, GM Genuine Parts and ACDelco help deliver the adrenaline you crave with OE and aftermarket parts that are backed by GM.

Available at over 29,000 locations nationwide or available online 24/7, 365.

CERTAINTY STARTS HERE



SCAN QR CODE TO LEARN MORE



GM-BACKED
limited warranty*



*Visit gmparts.com/warranty for details.

©2025 General Motors. All rights reserved. The marks appearing in this ad are the trademarks or service marks of GM, its subsidiaries, affiliates, or licensors.

GM SERVICE REPLACEMENT POWERTRAIN & CHEVROLET PERFORMANCE PARTS LIMITED WARRANTY FOR:

Engines, Engine Components, Transmissions, Transmission Components & Transfer Cases

General Motors Company ("GM") warrants to the purchaser for the time and/or mileage indicated below that it will repair or replace, at its option, any Genuine GM Parts Service Replacement Engine, Engine Component, Transmission/Transaxle, Transmission Component, Transfer Case, and Chevrolet Performance Engine, Transmission, Component and Short Block Assembly (as noted below) that fails due to a defect in material or workmanship. GM will use new or remanufactured parts for repair or replacement.

Warranty coverage is based on months/mileage, whichever comes first, and begins on the date of installation by an authorized GM Dealer or by a qualified Independent Service Center (ISC) or Electric Specialty Vehicle Modifier (eSVM). For all consumer installed, over-the-counter sales, warranty begins on date of retail sale.



Product	Cataloged Passenger Car & Light-Duty Truck (Series 10-30) ⁶	Cataloged Medium-Duty Truck (Series 40-80) Class A Motor Home, Taxi & Police ⁶	Non-Cataloged Passenger Car, Light-Duty Truck & Medium-Duty Truck ^{2,6}	Other (Start-up Warranty) ⁵
Engines, Automatic Transmissions & Transfer Cases ^{3,4}	36 months or 100,000 miles ^{1,2}	18 months or 100,000 miles ^{1,2}	12 months or 12,000 miles	30 Days
Manual Transmissions V Ti (CVT)	12 months or 12,000 miles ^{1,2}	12 months or 12,000 miles ^{1,2}	12 months or 12,000 miles	N/A
Engine & Transmission Components ^{5,8}	24 months/ unlimited miles	24 months/ unlimited miles	24 months/ unlimited miles	N/A

¹Parts and labor warranty when installed by a GM Dealer or qualified installing Independent Service Center (ISC). ²Parts and labor warranty when sold over the counter and REPAIRED by a GM Dealer or qualified installing Independent Service Center (ISC), on-highway applications only. ³Parts-only warranty when consumer-repaired or when installed in non-highway application. Coverage limited to defects in material and/or workmanship of the specific part only. ⁴Includes Allison 1000 Series assemblies sold through GM Dealers. ⁵Engine upgrades require appropriate associated parts to ensure proper engine and transmission cooling and torque capacity, fuel/air delivery and emission controls (upgrade example: 305 engine replaced with 350 engine). ⁶Parts-only warranty when sold over the counter. ⁷Must be installed in a "street legal" automotive application for use on public roads. ⁸Parts and labor warranty when installed by a GM Dealer.



Performance

Product	Passenger Car & Light-Duty Truck (Series 10-30) ⁴	Other (Start-up Warranty) ⁵
Chevrolet Performance Engines ⁴	24 months or 50,000 miles ^{1,2}	30 Days
Performance Transmissions ^{1,5}	12 months/unlimited miles	30 Days
E-ROD & E-ROD Connect & Cruise Crate Powertrain Systems ^{4,7,9}	36 months or 50,000 miles ^{1,2}	30 Days
Connect & Cruise Crate Powertrain Systems ^{4,7,9} (non-E-ROD)	24 months or 50,000 miles ^{1,2}	30 Days
eCrate ¹⁰	24 months or 50,000 miles ¹	30 Days
Performance Parts, Short Block Assemblies & Components ^{5,8}	24 months/unlimited miles	30 Days

¹Parts and labor warranty when installed by a GM Dealer or qualified installing Independent Service Center (ISC) or Electric Specialty Vehicle Modifier (eSVM). (Excludes C1350, C1400, C1525, DR and COPO Engines). ²Parts and labor warranty when sold over the counter and REPAIRED by a GM Dealer or qualified installing Independent Service Center (ISC). Coverage limited to defects in material and/or workmanship of the specific part only. (Excludes C1350, C1400, C1525, DR and COPO Engines). ³Engine upgrades require appropriate associated parts to ensure proper engine and transmission cooling and torque capacity, fuel/air delivery and emission controls (upgrade example: 305 engine replaced with 350 engine). ⁴Parts-only warranty when sold over the counter. ⁵Warranty valid when all required components are installed on the same vehicle and purchased per Connect and Cruise program guidelines. ⁶Parts and labor warranty when installed by a GM Dealer. ⁷Transmissions and components receive unlimited mileage warranty as part of the connect and cruise packages. ⁸eCrate systems must be installed and serviced at certified Electric Specialty Vehicle Modifier (eSVM) designated by Chevrolet Performance.

THIS WARRANTY DOES NOT COVER:

- Damage due to improper installation, negligence, alteration (including changes to engine controls), accident, or improper use. Proper vehicle use is discussed in the vehicle Owner's Manual.
- Any vehicle that has been used for racing (on or off track), stunt driving, performance testing, or used under other extreme operating conditions.
- Any vehicle where the odometer has been disconnected or the mileage reading has been altered.
- Damage caused by lack of proper maintenance as described in the vehicle's original Owner's Manual/ Maintenance Schedule, failure to follow Maintenance Schedule intervals, or failure to use or maintain proper type and levels of fluid, fuel, oil, and lubricants recommended in the Owner's Manual/Maintenance Schedule. Proof of proper maintenance is the owner's responsibility. Keep all receipts and be prepared to present them if questions arise about maintenance.
- Damage as a result of overheating, contamination or lack of lubrication.
- Damage caused by a turbocharger, supercharger, nitrous oxide, or similar product, which is not an approved Chevrolet Performance Part or Accessory.
- Racing engines and/or their components.
- Use of components in excess of maximum torque specification.
- Damage as a result of modification/replacement of torque converter that is part of transmission assembly.
- Loss of time, inconvenience, loss of use, or other economic loss.
- Vehicles registered and normally operated outside of North America.
- This warranty does not apply to any unit installed under the General Motors New Vehicle Limited Warranty.
- eCrate components modified by anyone since the original receipt of parts from the Dealer.
- eCrate HV Battery that has been opened by anyone since the original receipt from Dealer.
- Any system that has calibration or software altered.

DOCUMENTATION REQUIREMENTS:

The GM Dealer, Independent Service Center (ISC) or Electric Specialty Vehicle Modifier (eSVM). must be furnished with the purchaser's original repair order or sales slip (or Dealer's photo copy) showing vehicle identification number, installation date and mileage. This warranty is transferable to subsequent owners, free of charge, by providing the above required documents to any purchaser of the vehicle in which the assembly/component was originally installed.

OBTAINING REPAIRS:

GM Dealer Installation – The GM Dealer who initially installed the assembly/component or any other GM Dealer may perform the repairs. You must allow a reasonable period of time for repairs following delivery of the vehicle to the GM Dealer.

Independent Service Center/eSVM Installation – The Independent Service Center (ISC) or Electric Specialty Vehicle Modifier (eSVM) that installed the assembly/component or any GM Dealer may perform repairs. Before any repairs can be performed under warranty by an Independent Service Center, the selling GM Dealer (or any GM Dealer) must first authorize needed repairs as a sublet service.

Towing* – for GM Parts Engine, Transmission, and Transfer Case assemblies, will be covered to the nearest GM Dealership or ISC who performed the installation, not to exceed \$150.00, under the following conditions:

- The vehicle is inoperative.
- The failure was the result of the unit; not the installation.

*Chevrolet Performance Parts Engines and Transmissions are excluded.

Emergency Repairs (GM Dealers Only): Reimbursement to an owner for repairs performed by other than a GM Dealer will be considered when GM Dealer service was not available (e.g., weekends, evenings, etc.) or when repairs were made in a foreign country where warranty repairs by a GM Dealer are difficult to obtain.

OTHER TERMS:

GM sells other engines and transmissions in various states of completion. This warranty covers only those engines and transmissions that are marketed by GM as GM Parts or Chevrolet Performance Parts.

This warranty gives you specific legal rights, and you may also have other rights, which vary from state to state.

General Motors does not authorize any person to create for it any other obligations or liability in connection with these assemblies.

ANY IMPLIED WARRANTY OF MERCHANTABILITY OR FITNESS FOR A PARTICULAR PURPOSE APPLICABLE TO ASSEMBLIES OR PARTS IS LIMITED IN DURATION TO THE DURATION OF THIS WRITTEN WARRANTY. THE PERFORMANCE OF REPAIRS OR REPLACEMENT IS THE EXCLUSIVE REMEDY UNDER THIS WRITTEN WARRANTY OR ANY IMPLIED WARRANTY. GM SHALL NOT BE LIABLE FOR INCIDENTAL OR CONSEQUENTIAL DAMAGES RESULTING FROM BREACH OF THIS WRITTEN WARRANTY OR ANY IMPLIED WARRANTY.

Some states do not allow limitations on how long an implied warranty will last or the exclusion or limitation of incidental or consequential damages, therefore, the above limitation or exclusions may not apply to you.

SERVICE CHECKS:

Transmissions: It is important for you or a service technician to check the transmission/transaxle fluid level at regular intervals.

Engines: It is important for you or a service technician to perform these underhood checks at each fuel fill:

- Check engine oil level and add if necessary.
- Check engine coolant level in coolant reservoir and add if necessary.
- Check belts and hoses for visible wear and replace if necessary.

eCrate: It is important to have an eSVM perform these underhood checks.

Every 240 000 km (150,000 mi):

- Drain and fill vehicle coolant circuits. Or every five years, whichever comes first.
- Use only ACDelco Premix (50/50 mixture of de-ionized water and DEX-COOL Coolant).

Routine checks - 7,500 miles or 6 months, whichever comes first:

- Check for coolant level in reservoirs. If the coolant level is not visible or needs to be adjusted within the reservoirs, contact your eSVM.
- Visually check for fluid leaks. Contact your eSVM if there are any signs of a fluid leak.
- Please contact eSVM immediately if MIL light for eCrate propulsion system illuminates on the dash.

The parts listed in this catalog are intended primarily for use in racing, track applications or "off-road" vehicles—they are not intended for use on public roads. U.S. federal law and Canadian law prohibit an automobile manufacturer or Dealer from removing, modifying or rendering inoperative any part installed in compliance with an applicable Federal Motor Vehicle Safety Standard on a motor vehicle used on public roads.

Many parts intended for use on private property, including racing on a track, are not designed or tested for crashworthiness or to meet safety standards applicable to public-road use, and may adversely affect the original intended performance or handling characteristics of the vehicle. These parts are designed and intended to be used with experts supervising their installation and use, to help assure the proper and safe operation of the vehicle.

Vehicles equipped with Chevrolet Performance Parts also may not meet U.S. federal, state, or local emission laws, regulations, or ordinances, and may not be operated on public roads, streets, or highways or for non-competition purposes. Further, the federal government and many states and provinces have enacted laws with various penalties for tampering with or otherwise modifying any required emission or noise control system. Chevrolet Performance customers are responsible for ensuring their use of Chevrolet Performance Parts complies with applicable federal, state and local laws, regulations and ordinances. For additional information on compliance with emissions laws, please see page 2 or www.chevroletperformance.com/emissions.

© 2025 General Motors Co. All rights reserved.

Direct any inquiries to: General Motors LLC., Consumer Relations Dept., P.O. Box 33136, Detroit, MI 48232-5136



GM SERVICE REPLACEMENT POWERTRAIN & CHEVROLET PERFORMANCE LIMITED WARRANTY

Engines, Engine Components, Transmissions, Transmission Components & Transfer Cases

To retain the safety and dependability built into this product, it is essential that your product receives the scheduled maintenance at the recommended intervals contained in your vehicle Owner's Manual/Maintenance Schedule or Chevrolet Performance Engine Instruction Sheet. Since emissions-related components vary by model and engine application, you should follow the emissions maintenance recommendations also contained in your vehicle's manuals.

General Motors of Canada Company ("GM Canada") warrants to the purchaser for the time and/or mileage indicated below that it will repair or replace, at its option, any Genuine GM Parts Service Replacement Engine, Engine Component, Transmission/Transaxle, Transmission Component, Transfer Case or Short Block Assembly that fails due to a defect in material or workmanship. GM Canada will use new or remanufactured parts for repair or replacement.

Warranty coverage is based on months/mileage, whichever comes first, and begins on the date of installation by an authorized GM Canada Dealer or by a qualified Independent Canadian Service Center (ISC). For all other over-the-counter sales, warranty begins on date of retail sale.

GM Canada only warrants GM Canada supplied parts and components purchased in Canada from a GM Canada Dealer or Canadian qualified ISC.



Product	Cataloged Passenger Car & Light-Duty Truck (Series 10-30) ⁶	Medium-Duty Truck (Series 40-80) Class A Motor Home, Taxi & Police ⁶	Non-Cataloged Passenger Car & Light-Duty Truck ^{2,4}	Other (Start-up Warranty) ⁵
Engines, Automatic Transmissions & Transfer Cases ^{3,4}	36 months or 160,000 kilometers ^{1,2}	18 months or 160,000 kilometers ^{1,2}	12 months or 20,000 kilometers	30 Days
Manual Transmissions & CVT	12 months or 20,000 kilometers ^{1,2}	12 months or 20,000 kilometers ^{1,2}	12 months or 20,000 kilometers	N/A
Engine & Transmission Components ^{1,5}	12 months/ unlimited kilometers	12 months/ unlimited kilometers	12 months/ unlimited kilometers	N/A

¹Parts and labor warranty when installed by a GM Canada Dealer or qualified installing Independent Canadian Service Center (ISC). ²Parts and labor warranty when sold over the counter and REPAIRED by a GM Dealer or qualified installing Independent Service Center (ISC) on-highway applications only. Parts-only warranty when consumer-repaired or when installed in non-highway application. Coverage limited to defects in material and/or workmanship of the specific part only. ³Includes Allison 1000 Series assemblies sold through GM Dealers. ⁴Engine upgrades require appropriate associated parts to ensure proper engine and transmission cooling and torque capacity, fuel/air delivery and emission controls (upgrade example: 305 engine replaced with 350 engine). ⁵Parts-only warranty when sold over the counter. ⁶Must be installed in a "street legal" automotive application for use on public roads. ⁷Parts and labor warranty when installed by a GM Dealer.



Product	Passenger Car & Light-Duty Truck (Series 10-30) ⁶	Other (Start-up Warranty) ⁵
Chevrolet Performance Engines ⁴	24 months or 80,000 kilometers ^{1,2}	30 Days
Performance Transmissions ^{1,5}	12 months/ unlimited kilometers	30 Days
E-ROD & E-ROD Connect & Cruise Crate Powertrain Systems ^{4,7,9}	36 months or 80,000 kilometers ^{1,2}	N/A
Connect & Cruise Crate Powertrain Systems ^{4,7,9} (non-E-ROD)	24 months or 80,000 kilometers ^{1,2}	N/A
Chevrolet Performance Parts ⁷ , Short Block Assemblies & Components ^{5,8}	12 months/unlimited kilometers	30 Days

¹Parts and labor warranty when installed by a GM Canada Dealer or qualified installing Independent Service Center (ISC). (Excludes CT350, CT400, CT525, DR and COPO Engines.) ²Parts and labor warranty when sold over the counter and REPAIRED by a GM Canada Dealer or qualified installing Independent Canadian Service Center (ISC). Coverage limited to defects in material and/or workmanship of the specific part only. (Excludes CT350, CT400, CT525, DR and COPO Engines.) ⁴Engine upgrades require appropriate associated parts to ensure proper engine and transmission cooling and torque capacity, fuel/air delivery and emission controls (upgrade example: 305 engine replaced with 350 engine). ⁵Parts-only warranty when sold over the counter. ⁷Warranty valid when all required components are installed on the same vehicle and purchased per Connect and Cruise program guidelines. ⁸Parts and labor warranty when installed by a GM Dealer. ⁹Transmissions and components receive unlimited mileage warranty as part of the Connect and Cruise packages.

WARRANTY BEGINS ON THE DATE OF INSTALLATION BY AN AUTHORIZED GM CANADA DEALER OR BY A CANADIAN QUALIFIED INDEPENDENT SERVICE CENTER. PARTS-ONLY WARRANTY (NO LABOUR) APPLIES FOR WARRANTY REPAIRS NOT PERFORMED BY A CANADIAN AUTHORIZED GM CANADA DEALER OR QUALIFIED INDEPENDENT SERVICE CENTER.

GM Canada sells other engines and transmissions in various states of completion. This warranty covers only those engines and transmissions that are marketed by GM Canada as Genuine GM Parts or Chevrolet Performance parts.

THIS WARRANTY DOES NOT COVER:

- Damage due to improper installation, negligence, alteration (including changes to engine controls), accident, improper use, or any use related to racing or competition. Proper vehicle use is discussed in the vehicle Owner's Manual. In addition, coverage does not apply if the odometer has been disconnected or the mileage reading has been altered.
- Any vehicle that has been used for racing (on or off track), stunt driving, performance testing, or used under other extreme operating conditions.

- Damage caused by lack of proper maintenance as described in the vehicle's original Maintenance Schedule/Owner's Manual, failure to follow Maintenance Schedule intervals, or failure to use or maintain proper type and levels of fluid, fuel, oil and lubricants recommended in the Maintenance Schedule/Owner's Manual. Proof of proper maintenance is the owner's responsibility. Keep all receipts and be prepared to make them available if questions arise about maintenance.
- Damage as a result of overheating, contamination or lack of lubrication.
- Damage caused by a turbocharger, supercharger, nitrous oxide, or similar product, which is not an approved GM Performance Part or Accessory.
- Racing engines and/or their components.
- Use of components in excess of maximum torque specification.
- Damage as a result of modification/replacement of torque converter that is part of transmission assembly.
- Loss of time, inconvenience, loss of use, or other economic loss.
- Vehicles registered and normally operated outside of North America.
- This warranty does not apply to any unit installed under the General Motors New Vehicle Warranty.

DOCUMENTATION REQUIREMENTS

The GM Canada Dealer or independent service center must be furnished with this warranty statement, purchase receipt, installation date invoice with mileage and proof of proper maintenance. This warranty is transferable to subsequent owners by providing the above required documents to any purchaser of the vehicle in which the assembly/component was originally installed.

OBTAINING REPAIRS

GM Canada Dealer Installation—The GM Canada Dealer who initially installed the assembly/component or any GM Canada Dealer may perform the repairs. You must allow a reasonable period of time for repairs following delivery of the vehicle to the GM Canada Dealer's place of business.

Independent Service Center Installation—The Canadian independent service center that installed the assembly/component or any GM Canada Dealer may perform repairs. Before any repairs can be performed under warranty by a Canadian independent repair center, the selling GM Canada Dealer (or any GM Canada Dealer) must first authorize needed repairs as a sublet service.

Towing—for GM Parts Engine, Transmission, and Transfer Case assemblies will not be covered.

OTHER TERMS

TO THE FULL EXTENT PERMITTED BY APPLICABLE CANADIAN LAW: The foregoing warranty is the only and the entire warranty provided by GM Canada and is in lieu of and excludes all other representations, warranties or conditions, express or implied (including any implied warranty or condition of merchantability or fitness for a particular purpose).

The performance of repairs, the provision of replacement parts, or reimbursement thereof, as described above, is the exclusive remedy under this written warranty or under any otherwise applicable implied warranty or condition.

Any implied warranty or condition that cannot be disclaimed or excluded is limited in duration to the periods specified in this written warranty.

GM CANADA DOES NOT AUTHORIZE ANY PERSON TO CREATE FOR IT ANY OTHER OBLIGATIONS or liability in connection with the products and no person is permitted to extend or enlarge this warranty on behalf of GM Canada by written, verbal or other representation and if made, such representation or warranty will not be enforceable against GM Canada.

DISCLAIMER OF LIABILITY: Except as provided in this limited warranty, GM Canada will not be liable in contract, tort or otherwise for any direct, indirect, economic, commercial, incidental, or consequential or special loss or damage or expense or claim howsoever caused, arising in connection with the sale, use, loss of use, performance or non-performance of the product.

NOTICE REGARDING LIMITATIONS: The terms contained in this limited warranty are not intended to limit or otherwise modify or exclude any warranty that by law cannot be limited, disclaimed or excluded. When and to the extent that any applicable Canadian law prohibits in a particular situation, any term contained in this warranty, such term will be considered severable and deemed deleted from this warranty in that situation.

Some provinces do not allow limitations on how long an implied warranty will last or the exclusion or limitation of incidental or consequential damages, therefore, the above limitation or exclusions may not apply to you.

SERVICE CHECKS:

Transmissions: It is important for you or a service technician to check the transmission/transaxle fluid level at regular intervals.

Engines: It is important for you or a service technician to perform these under-hood checks at each fuel fill:

- Check engine oil level and add if necessary.
- Check engine coolant level in coolant reservoir and add if necessary.
- Check belts and hoses for visible wear and replace if necessary.

Unless specifically noted to the contrary herein, vehicles equipped with Chevrolet Performance Parts may not meet Federal Motor Vehicle Safety Standards and emissions regulations and should not be operated on public roads. Chevrolet Performance customers are responsible for ensuring their use of Chevrolet Performance Parts complies with applicable federal, provincial and local laws, regulations and ordinances.

© 2025 General Motors Co. All rights reserved.





Performance

JOIN THE CONVERSATION

Follow the Official @ChevroletPerformance social channels for the latest on new products, exclusive content and more!

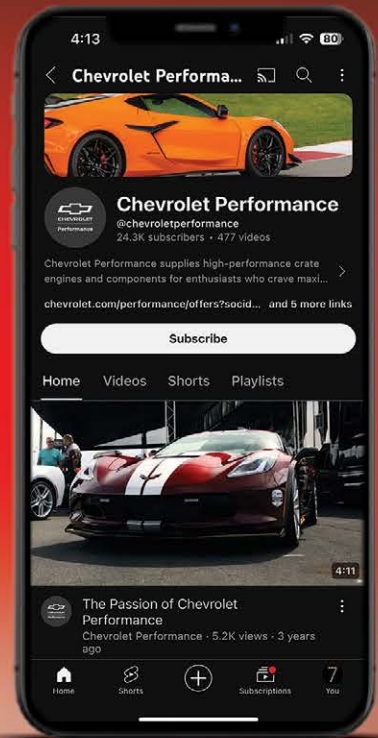
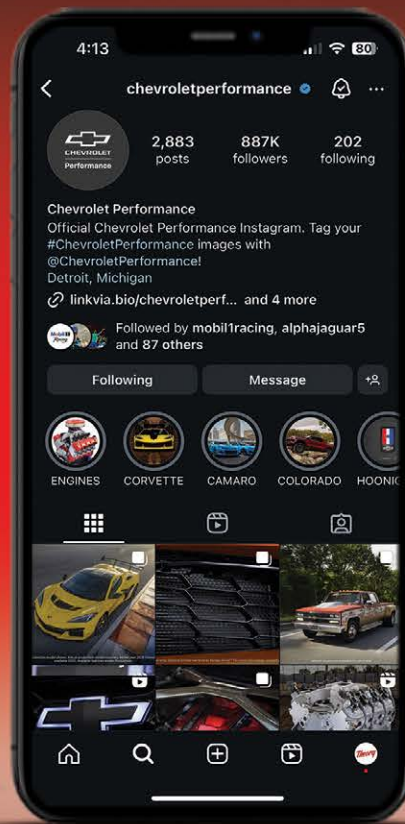
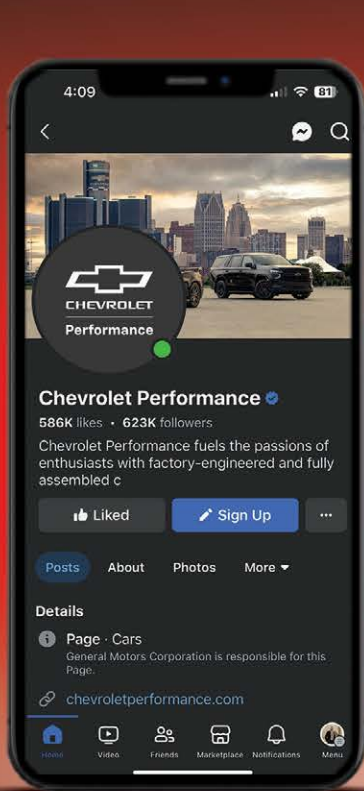

LIKE



FOLLOW



WATCH





We've got you covered!

With six distinct crate engine families and dozens of individual engine kits and variations, chances are we've got just what you're looking for.

SMALL-BLOCK ENGINE FAMILY

Classic power and style for your dream project

Page 116

CIRCLE TRACK ENGINE FAMILY

Factory-sealed, purpose-built performance race engines

Page 136

BIG-BLOCK ENGINE FAMILY

Industrial strength power for work, play and heavy-duty performance

Page 166

LS SERIES ENGINE FAMILY

Modern muscle for your restoration or swap project

Page 40

LT SERIES ENGINE FAMILY

Ultra-modern, high-tech performance in a convenient package

Page 66

LSX SERIES ENGINE FAMILY

Power and durability for extreme performance conditions

Page 80

Put Your Trust in Chevrolet Performance.

YOUR AUTHORIZED CHEVROLET PERFORMANCE CENTER



Find a Chevrolet Performance Authorized Center near you

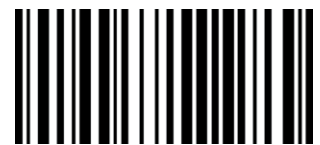

19540548



Performance